

HardCabs

A DFK AMERICA COMPANY

SPARE - PARTS CATALOG

KAWASAKI

MULE 610

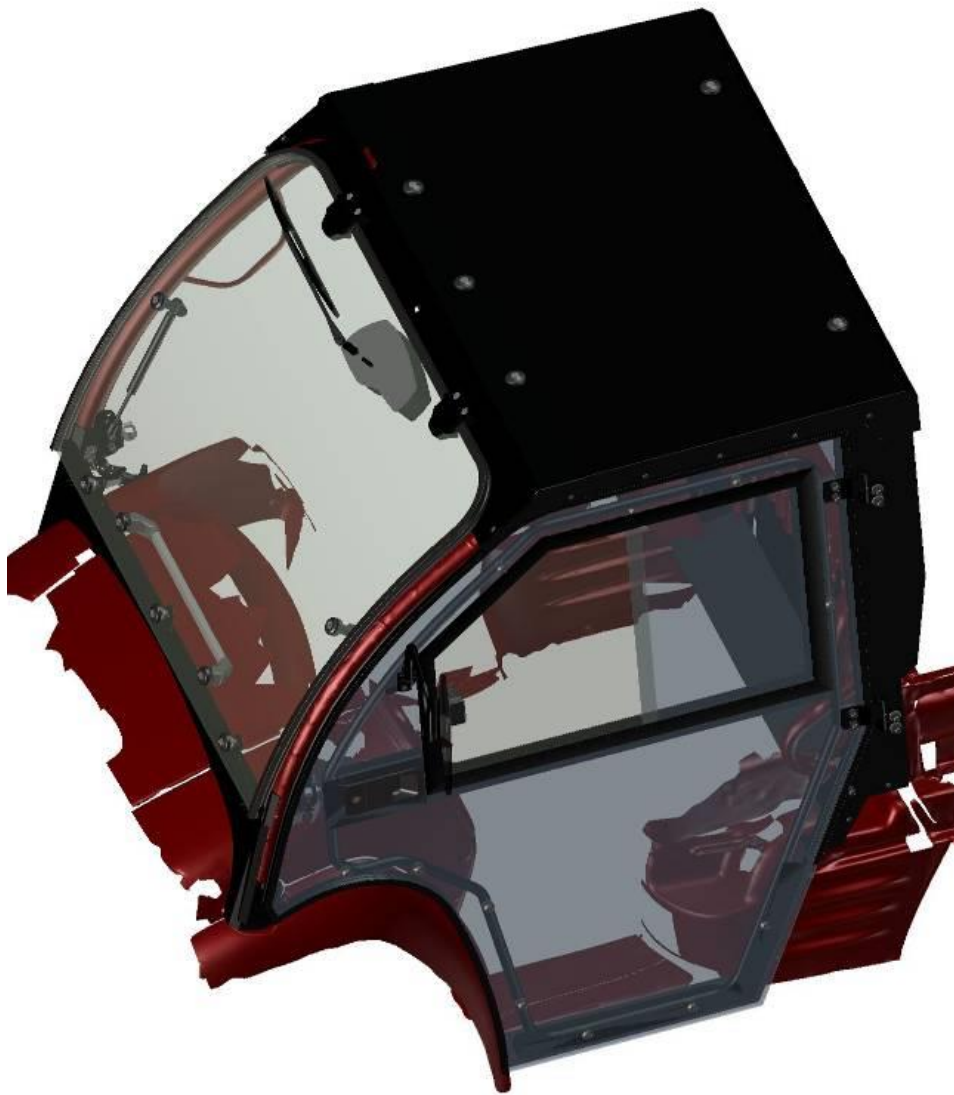

CAB PREVIEW

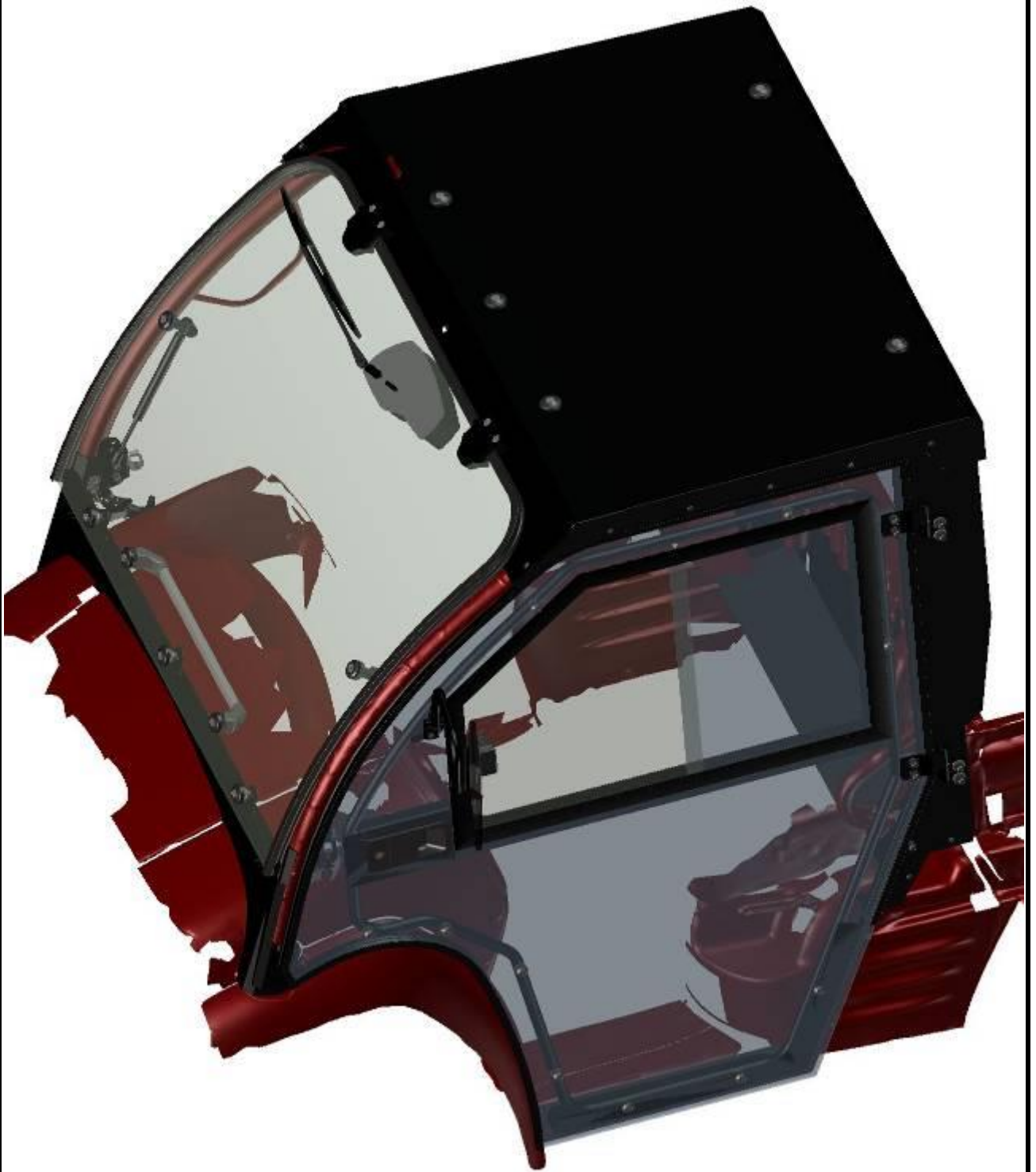

2

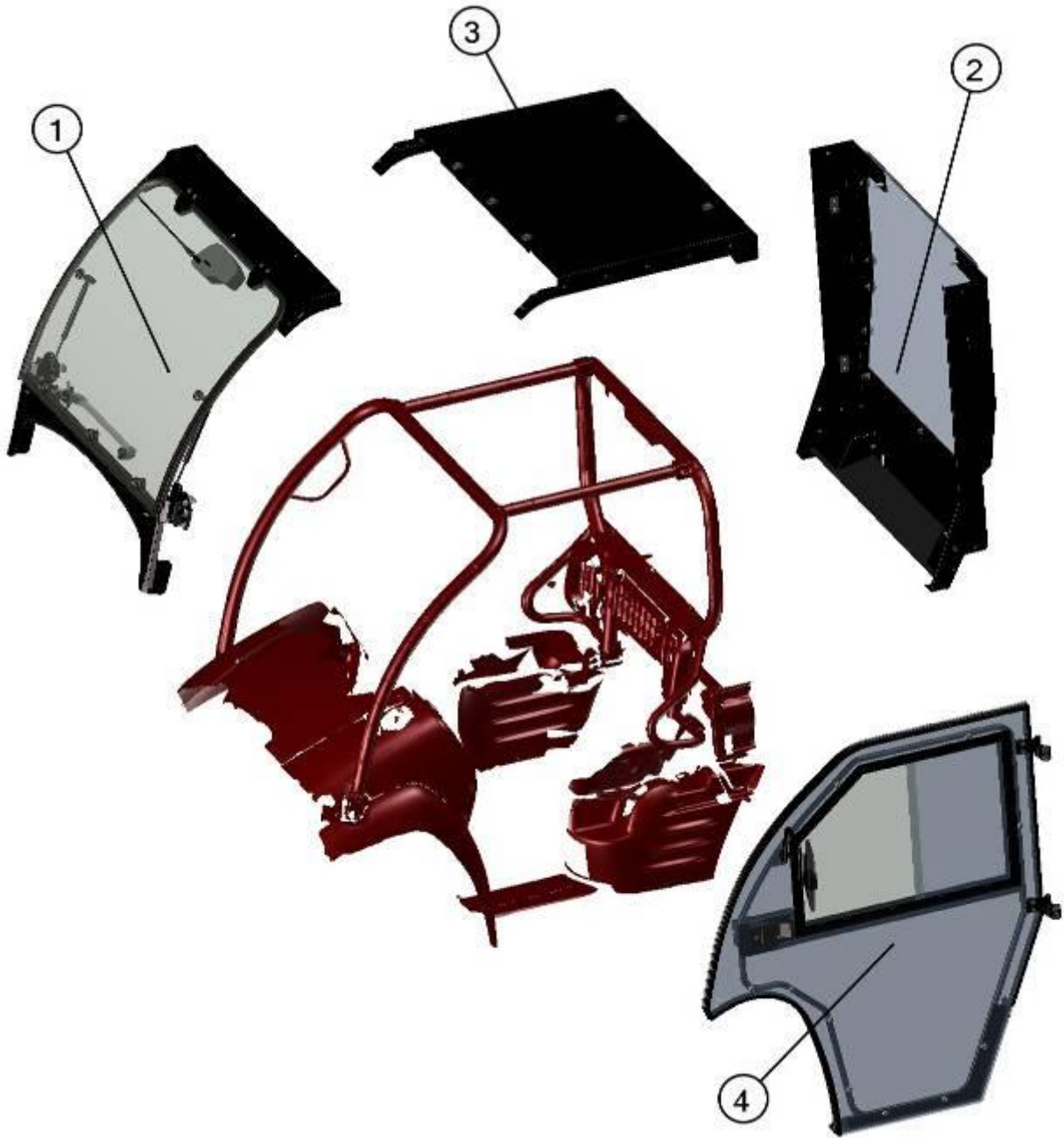

3

Position	Catalogue no.	Description	Qty
1	42S02U01S10	FRONT PANEL MOVABLE	1
2	42S02U01S20	REAR PANEL	1
3	42S02U01S30	ROOF	1
4	42S02U01S40	LEFT DOOR	1

FRONT PANEL





Position	Catalogue no.	Description	Qty
1	-----	UPPER FRONT ASSEMBLY	1
2	-----	BOTTOM FRONT ASSEMBLY	1

UPPER FRONT ASSEMBLY



6

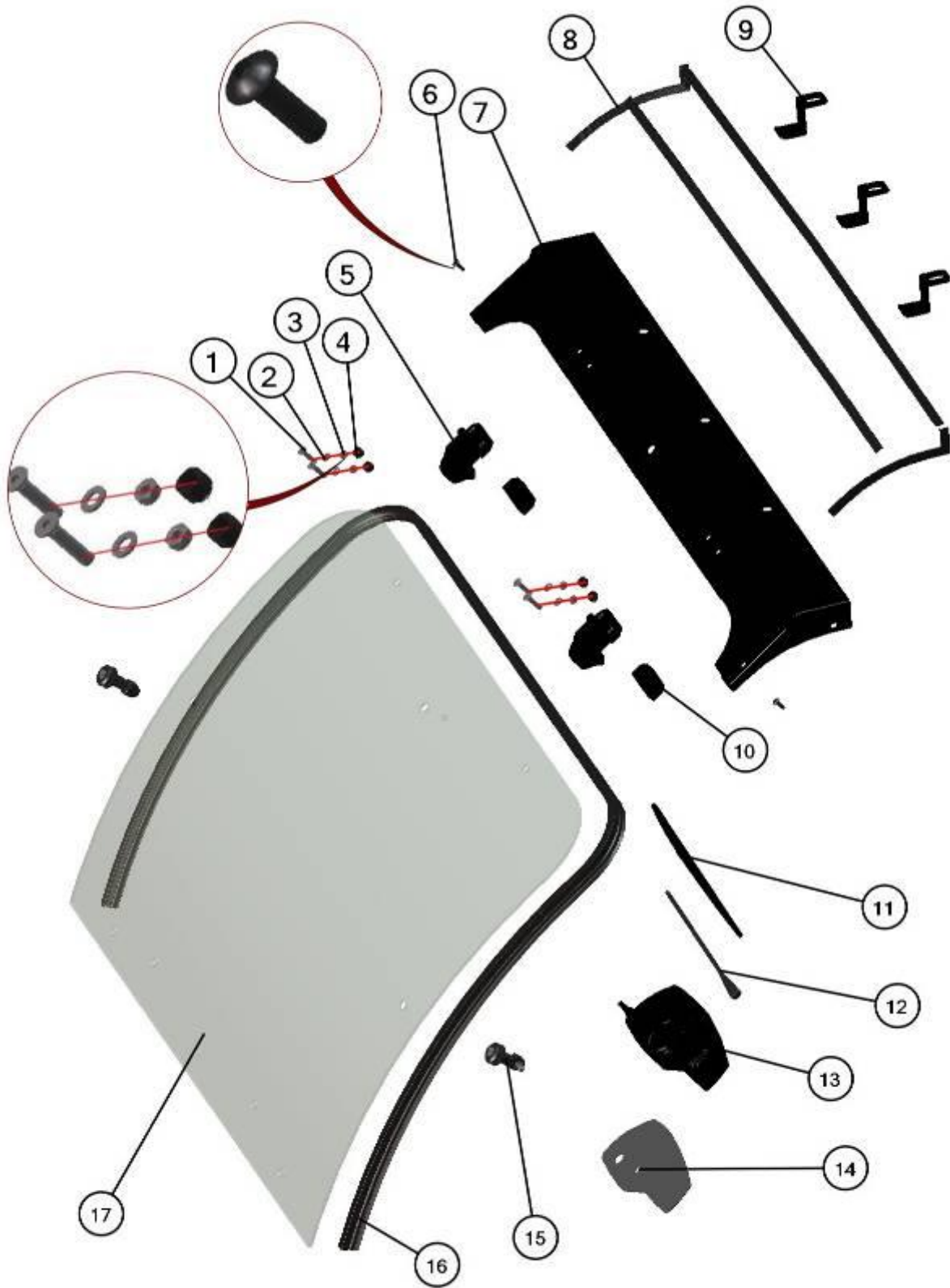

Position	Catalogue no.	Description	Qty
1	001395	SCREW M8x35	4
2	001387	WASHER 8	4
3	001388	SELF-LOCKING NUT M8	4
4	001309	PLASTIC NUT COVER OK13	4
5	000862	HINGE	2
6	001723	SCREW M6x20	2
7	42S02U01-10W001	FRONT UPPER LEDGE	1
8	001771^42S02U01S10	SEAL "KR 15x4"	1
9	00-101U-005	FRONT UPPER HOLDER	3
10	000863	HINGE WASHER	2
11	000798	WIPER LATH	1
12	001764	WIPER ARM	1
13	001763	WIPER MOTOR	1
14	00-025E02	WIPER MOTOR MIDDLE COVER	1
15	00-20M005	GAS SPRING HOLDER	2
16	002557^42S02U01-10M001	RUBBER PROFILE "PIRELA LONG"	1
17	42S02U01-10-002	FRONT GLASS	1

BOTTOM FRONT ASSEMBLY



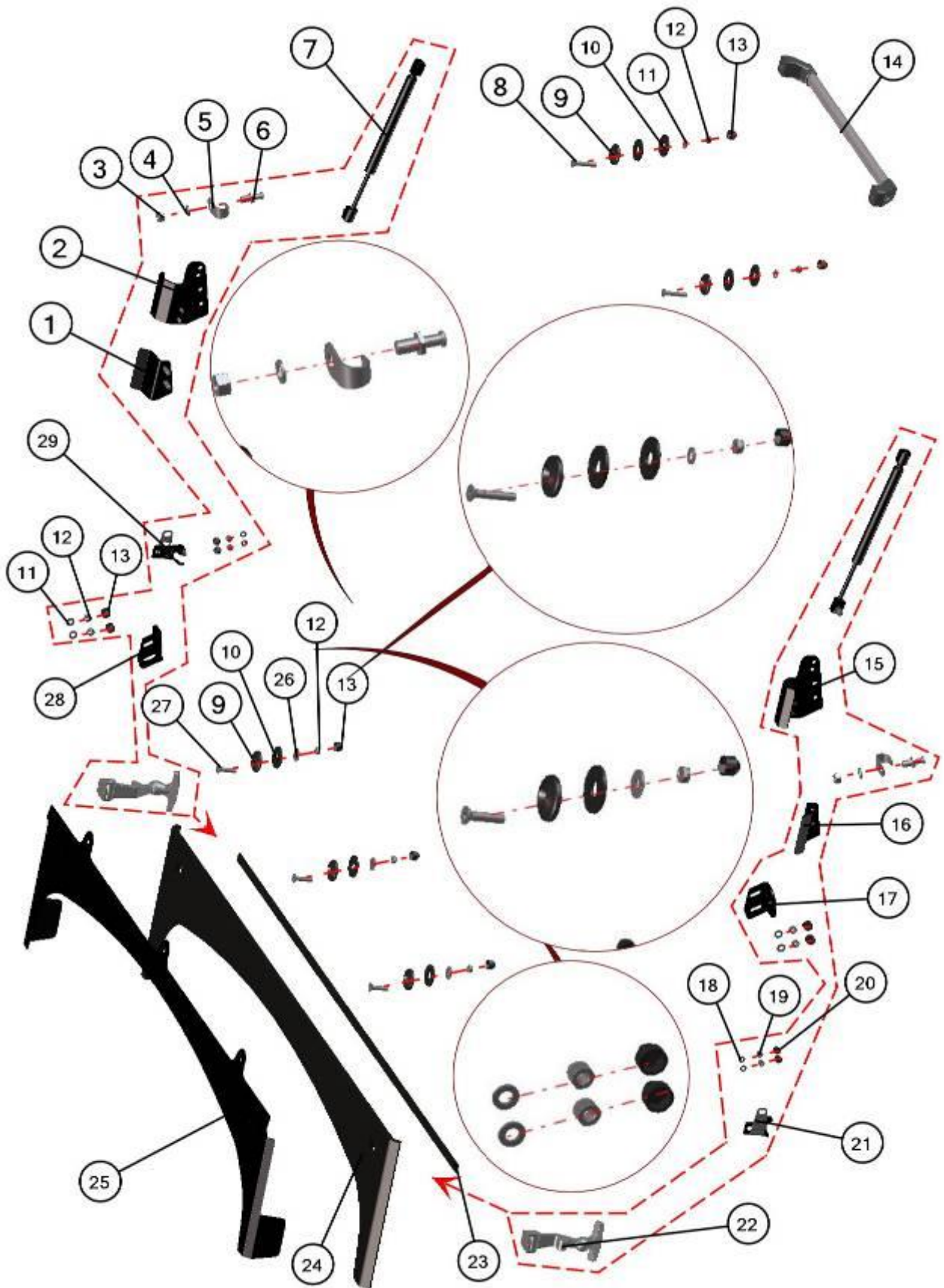

10

Position	Catalogue no.	Description	Qty
1	42S02U01-10W004	RIGHT OUTER HOLDER	1
2	42S02U01-10W005	RIGHT INNER HOLDER	1
3	000856	DOOR STOP NUT	2
4	000857	DOOR STOP WASHER	2
5	000855	DOOR STOP HOOK	2
6	000854	DOOR STOP PIN	2
7	002494	GAS SPRING	2
8	001694	SCREW M8x45	2
9	001429	PLASTIC WASHER 8	5
10	001428	RUBBER WASHER 8	7
11	001387	WASHER 8	6
12	001388	SELF-LOCKING NUT M8	9
13	001309	PLASTIC NUT COVER OK13	8
14	002496	HANDLE	1
15	42S02U01-10W003	LEFT INNER HOLDER	1
16	42S02U01-10W002	LEFT OUTER HOLDER	1
17	42S02U01-10-007	LEFT DOOR STOP HOLDER	1
18	001426	WASHER 6	4
19	001392	SELF-LOCKING NUT M6	4
20	001348	PLASTIC NUT COVER OK 10	4
21	42S02U01-10M005	LEFT GLASS STOP	1
22	002384	GLASS LOCK	1
23	001771^42S02U01-10M003	SEAL "KR 15x4"	1
24	42S02U01-10-004	FRONT BOTTOM LEDGE EPDM	1
25	42S02U01-10-003	FRONT BOTTOM LEDGE METAL	1
26	001407	WASHER 8 LARGE	3
27	001760	SCREW M8x35	3
28	42S02U01-10-011	RIGHT DOOR STOP HOLDER	1
29	42S02U01-10M007	RIGHT GLASS STOP	1

REAR PANEL

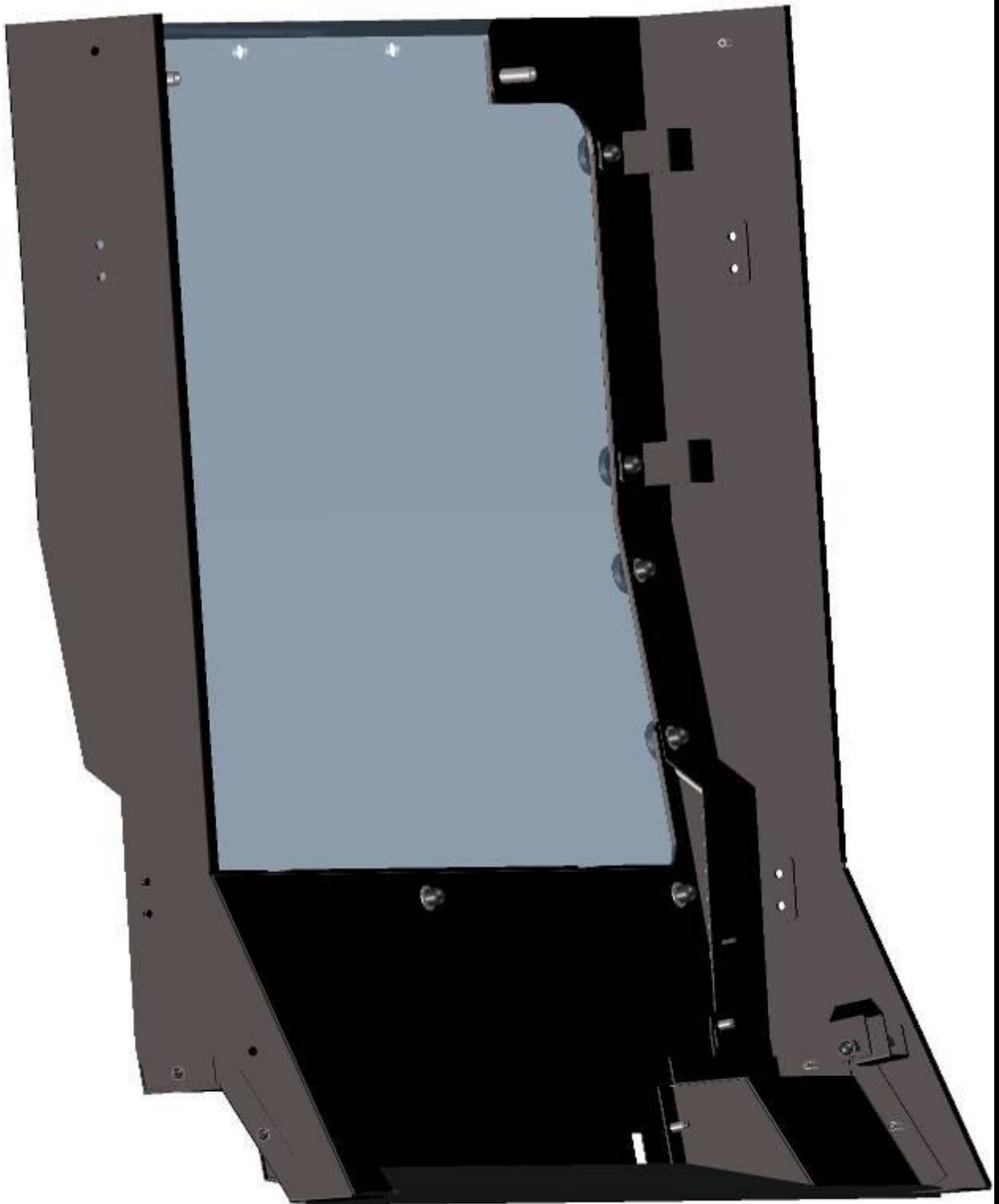

12

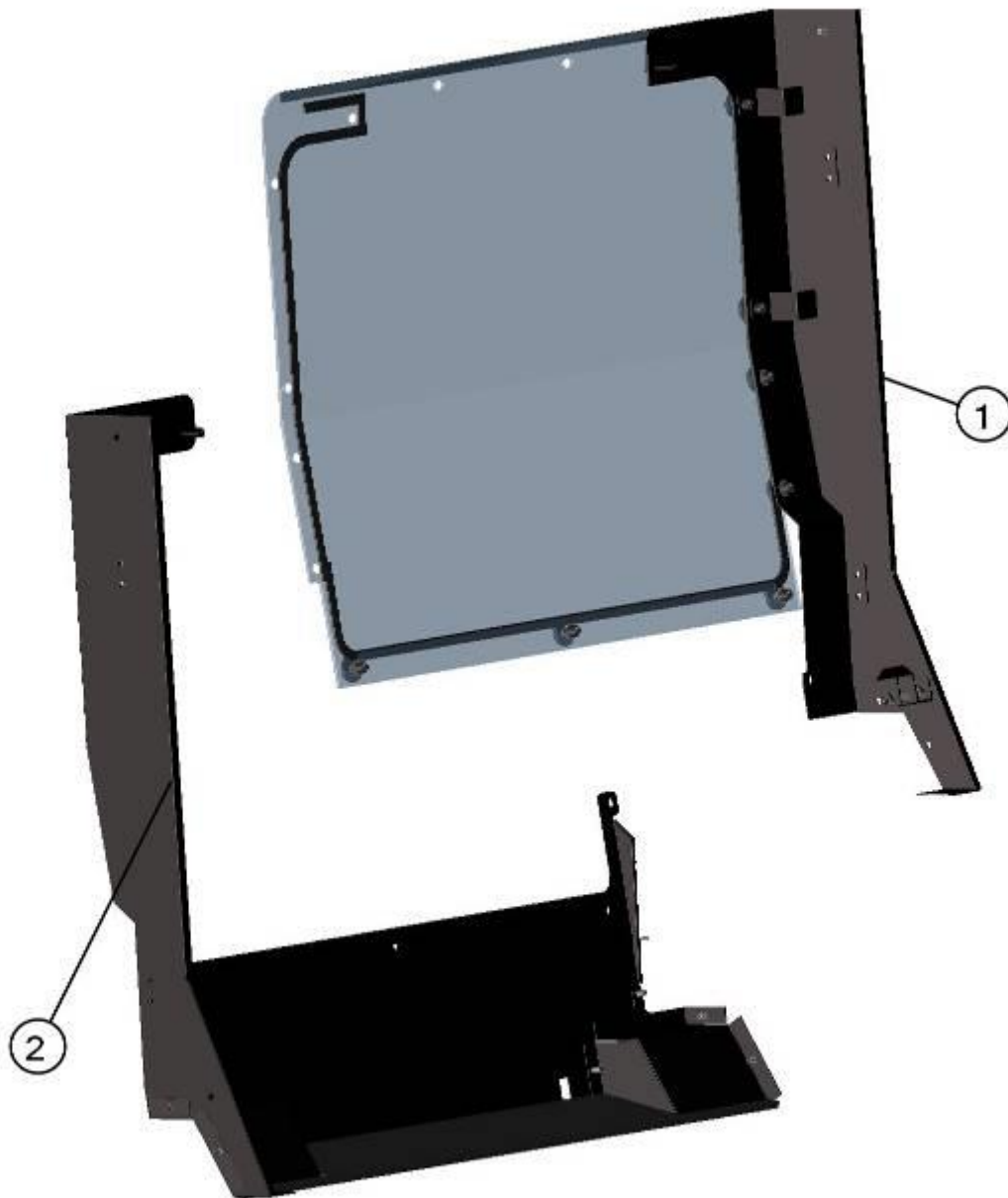

13

Position	Catalogue no.	Description	Qty
1	-----	REAR UPPER LEFT ASSEMBLY	1
2	-----	REAR BOTTOM RIGHT ASSEMBLY	1

REAR UPPER LEFT ASSEMBLY

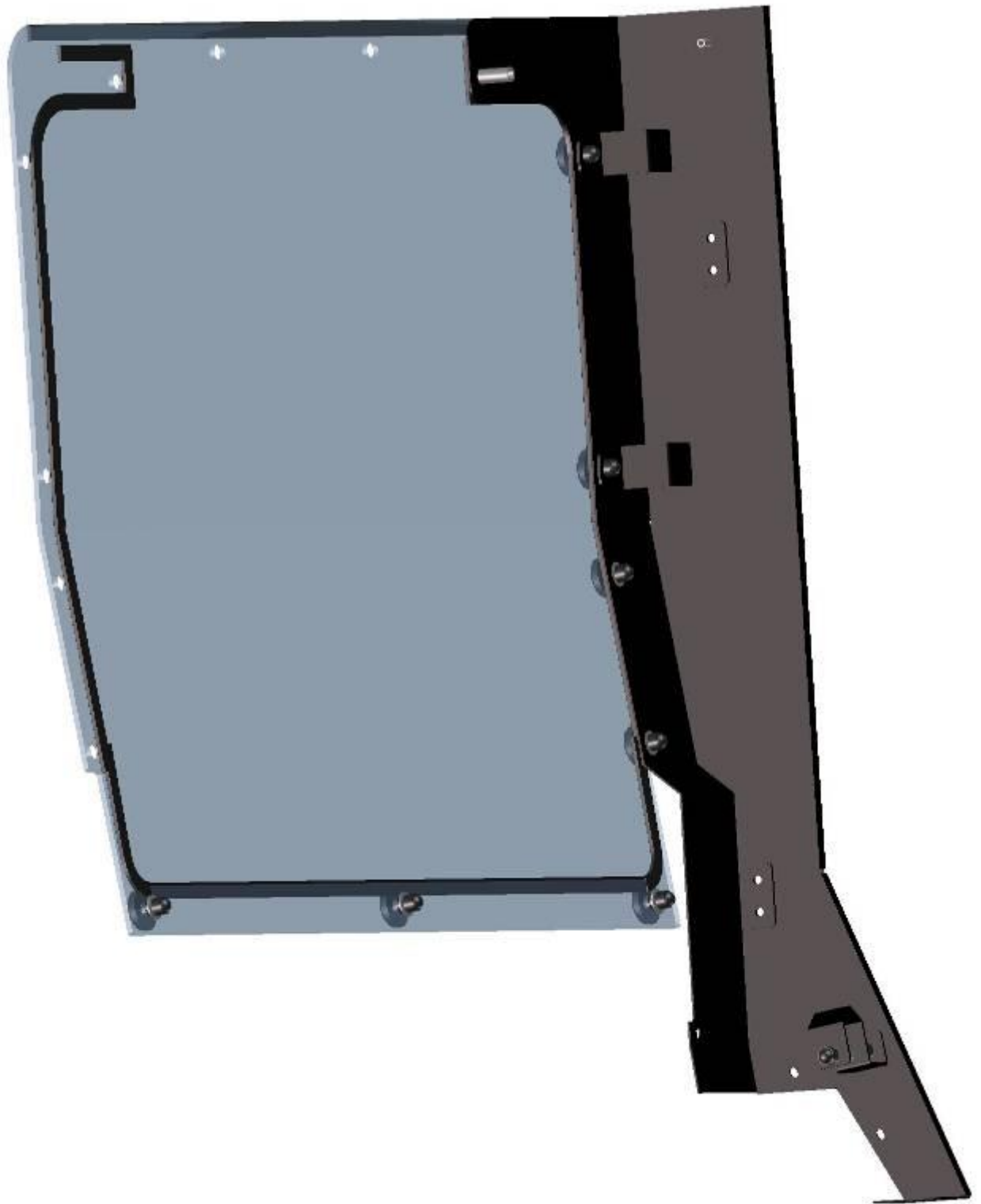

14

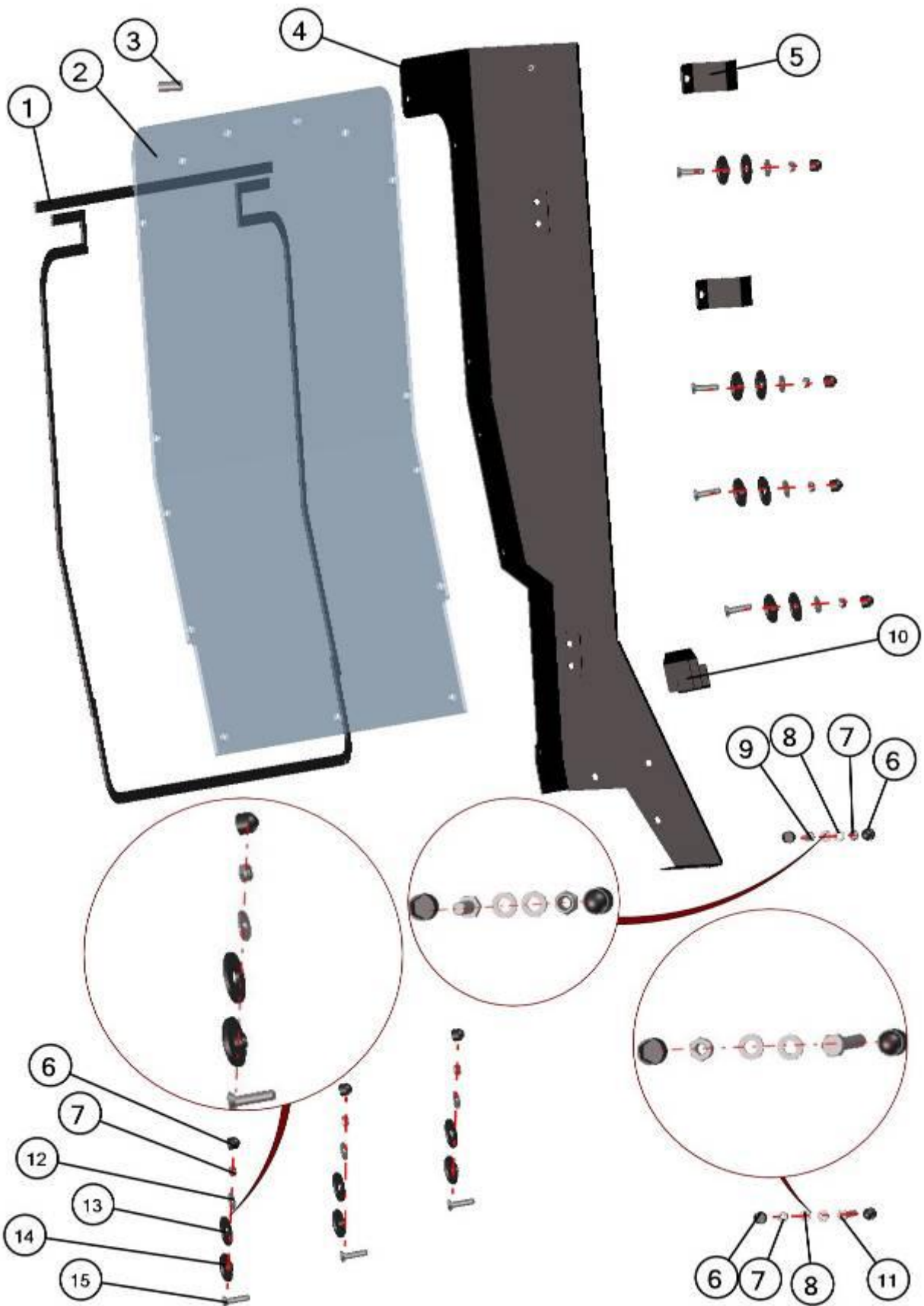

15

Position	Catalogue no.	Description	Qty
1	001771^42S02U01S20	SEAL "KR15x4"	1
2	42S02U01-20-003	REAR POLYCARBONATE WINDOW	1
3	42S02U01-20-009	DISTANCE HOSE	1
4	42S02U01-20W001	LEFT DOOR BASE	1
5	00-101U-005	REAR MIDDLE HOLDER	2
6	001309	PLASTIC NUT COVER OK13	11
7	001388	SELF-LOCKING NUT M8	9
8	001387	WASHER 8	4
9	001437	SCREW M8x20	1
10	42S02U01-20-008	DOOR BASE BOTTOM HOLDER	1
11	001438	SCREW M8x50	1
12	001407	WASHER 8 LARGE	7
13	001428	RUBBER WASHER 8	7
14	001429	PLASTIC WASHER 8	7
15	001760	SCREW M8x35	7

REAR BOTTOM RIGHT ASSEMBLY

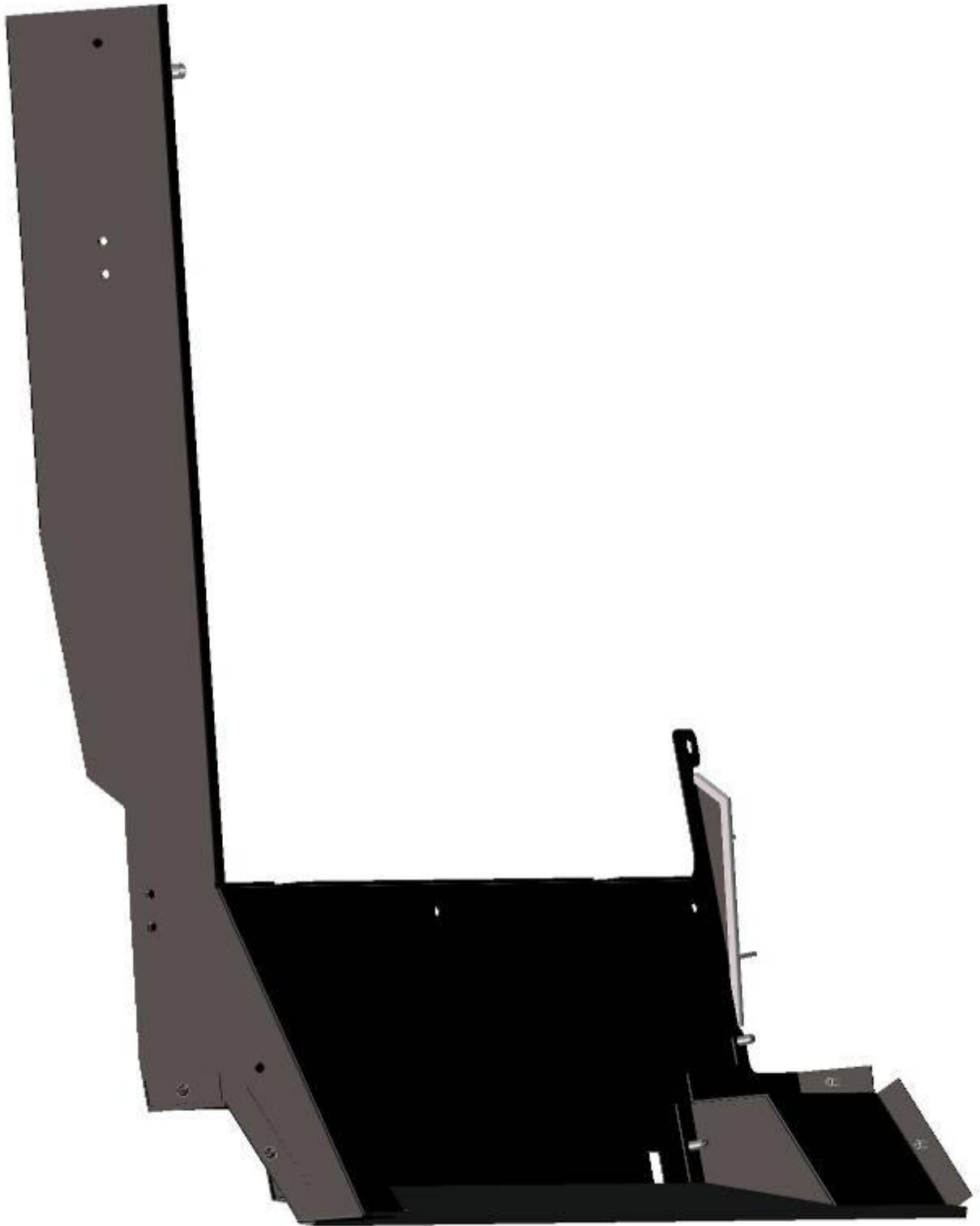

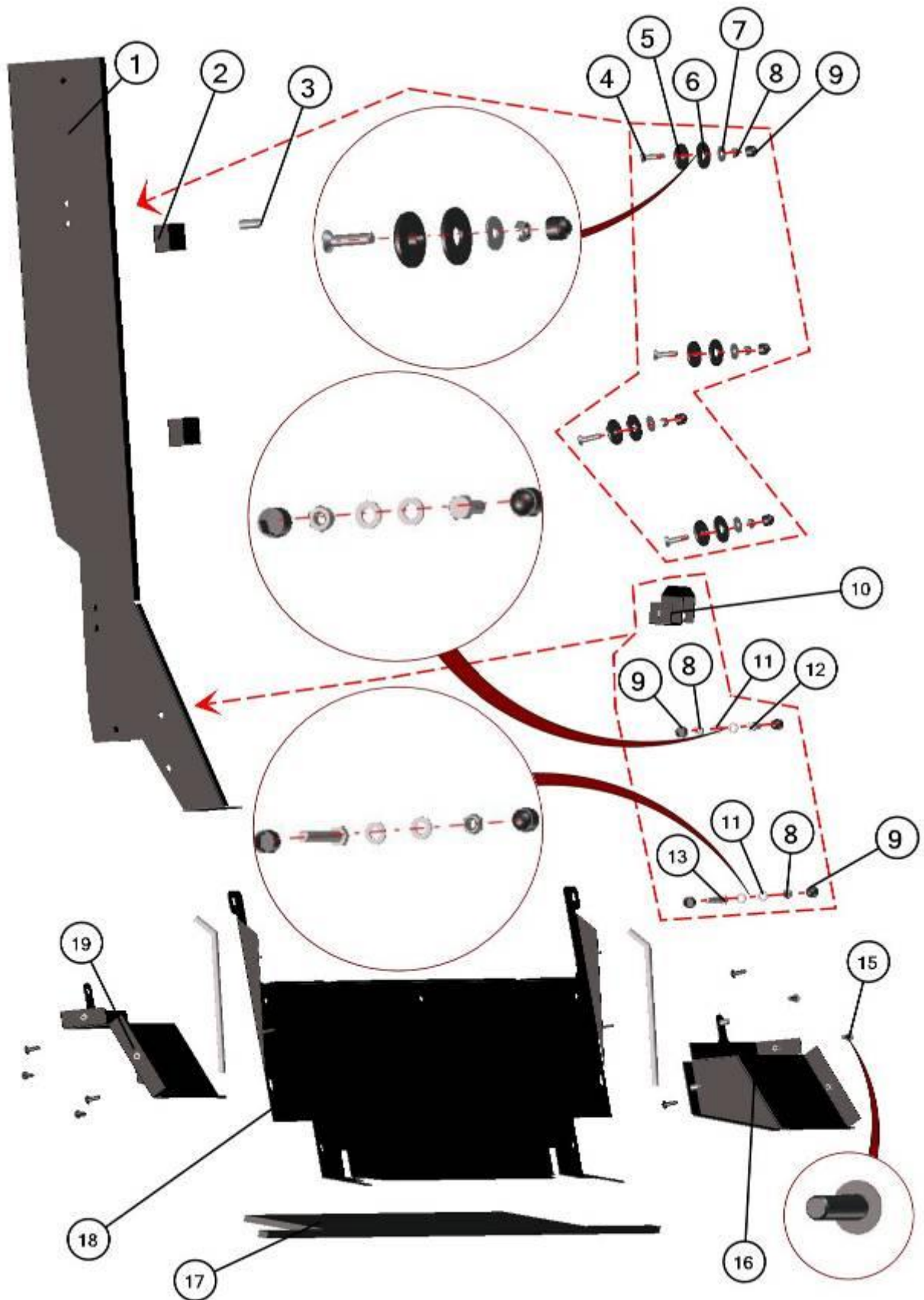

Position	Catalogue no.	Description	Qty
1	42S02U01-20W002	RIGHT DOOR BASE	1
2	00-101U-005	DOOR BASE MIDDLE HOLDER	2
3	42S02U01-20-009	DISTANCE TUBE	1
4	001760	SCREW M8x35	4
5	001429	PLASTIC WASHER 8	4
6	001428	RUBBER WASHER 8	4
7	001407	WASHER 8 LARGE	3
8	001388	SELF-LOCKING NUT M8	6
9	001309	PLASTIC NUT COVER OK13	8
10	42S02U01-20-008	DOOR BASE BOTTOM HOLDER	1
11	001387	WASHER 8	4
12	001437	SCREW M8x20	1
13	001438	SCREW M8x50	1
14	001001^42S02U01S20	RUBBER PROFILE "LEMOVKA"	2
15	001723	SCREW M6x20	8
16	42S02U01-20W003	LEFT BOTTOM COVER	1
17	42S02U01-20-007	REAR BOTTOM LEDGE EPDM	1
18	42S02U01-20-002	REAR BOTTOM LEDGE METAL	1
19	42S02U01-20W004	RIGHT BOTTOM COVER	1

ROOF



20

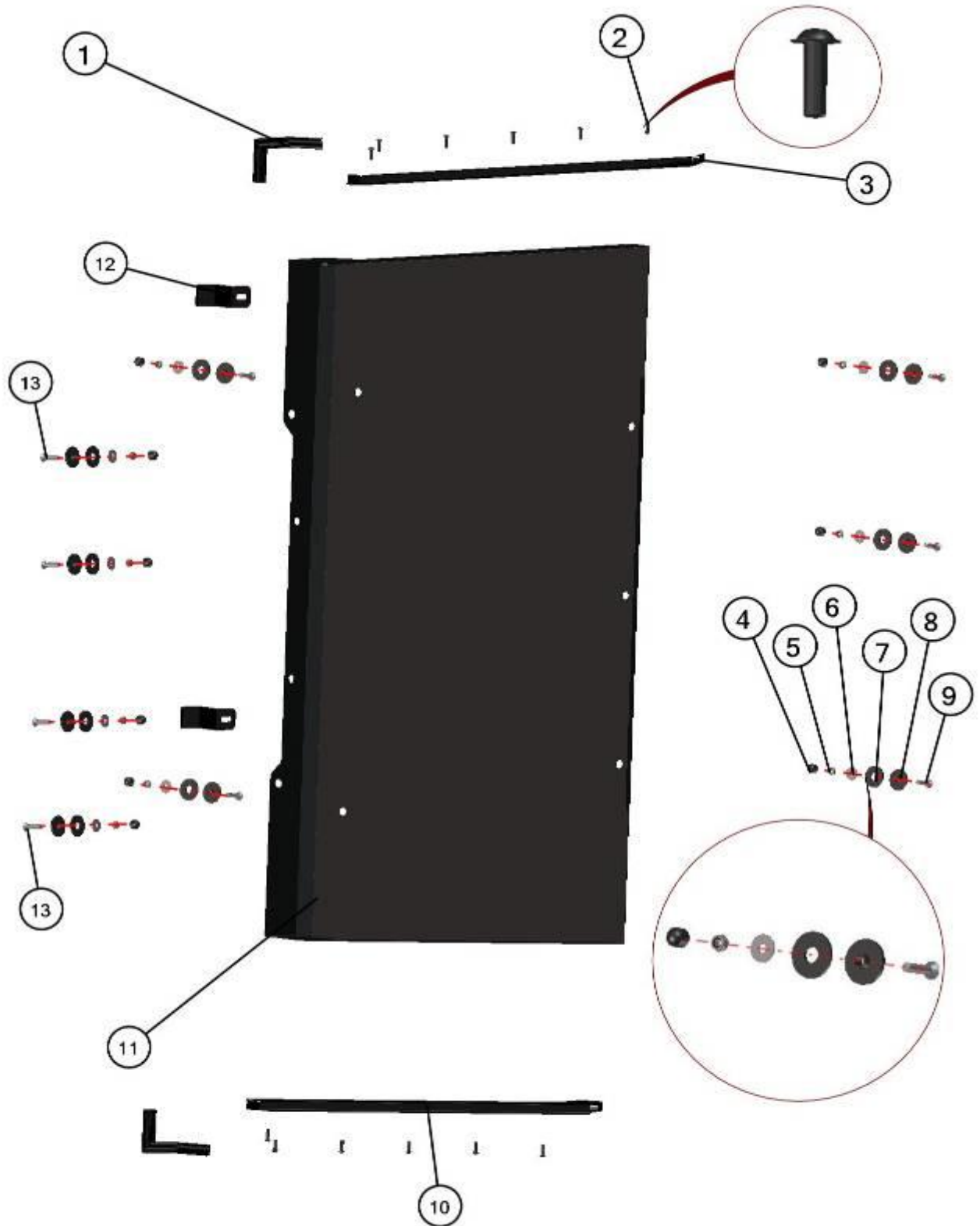

Position	Catalogue no.	Description	Qty
1	001010^42S02U01S30	RUBBER PROFILE "SARAZIN"	2
2	001723	SCREW M6x20	12
3	42S02U01-30W002	RIGHT ROOF LEDGE	1
4	001309	PLASTIC NUT COVER OK 13	9
5	001388	SELF-LOCKING NUT M8	9
6	001407	WASHER 8 LARGE	9
7	001428	RUBBER WASHER 8	9
8	001429	PLASTIC WASHER 8	9
9	001760	SCREW M8x35	6
10	42S02U01-30W001	LEFT ROOF LEDGE	1
11	42S02U01-30-001	ROOF PANEL	1
12	00-101U-005	REAR ROOF HOLDER	2
13	001399	SCREW M8x60	2

LEFT + RIGHT DOOR

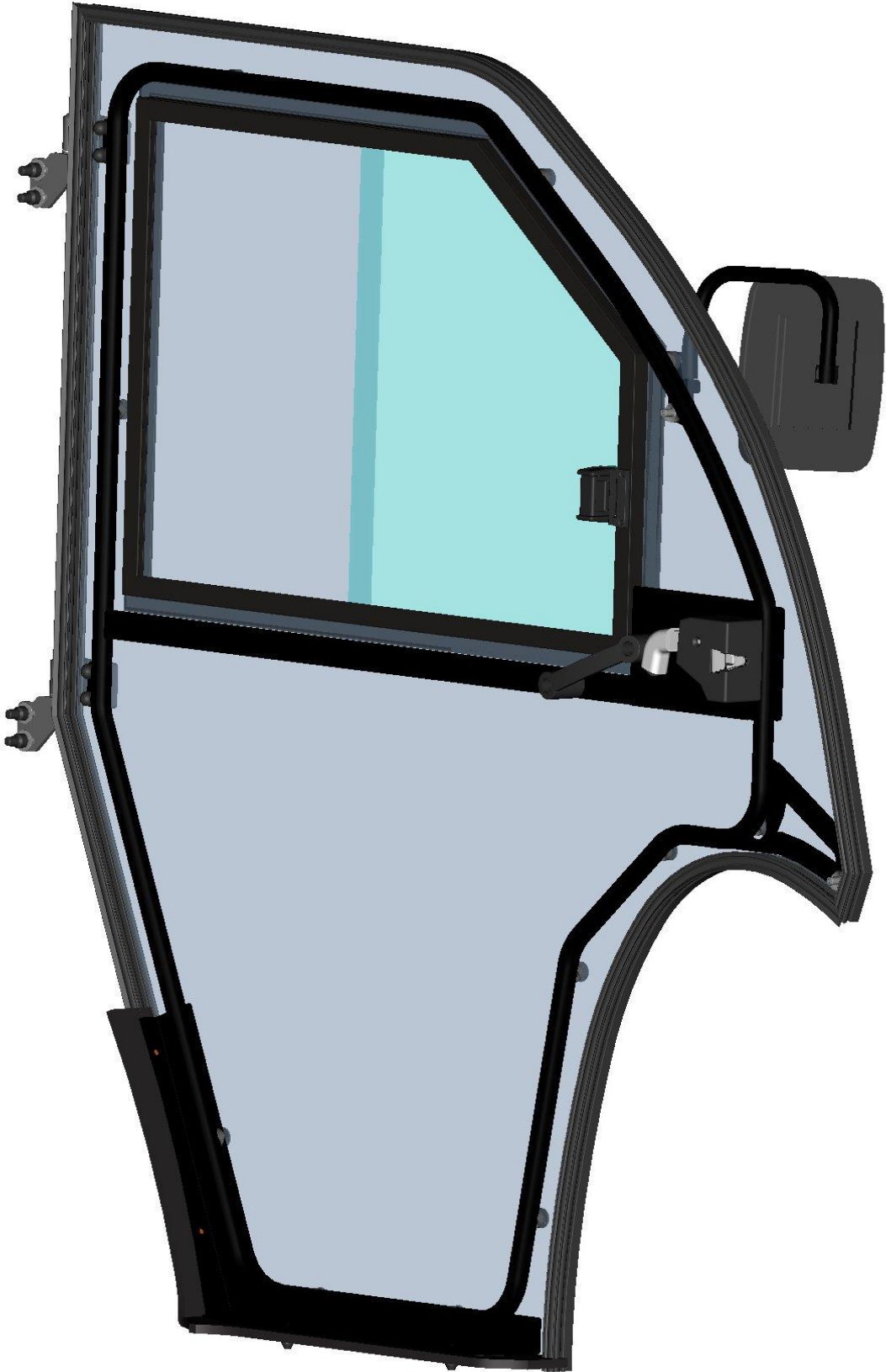

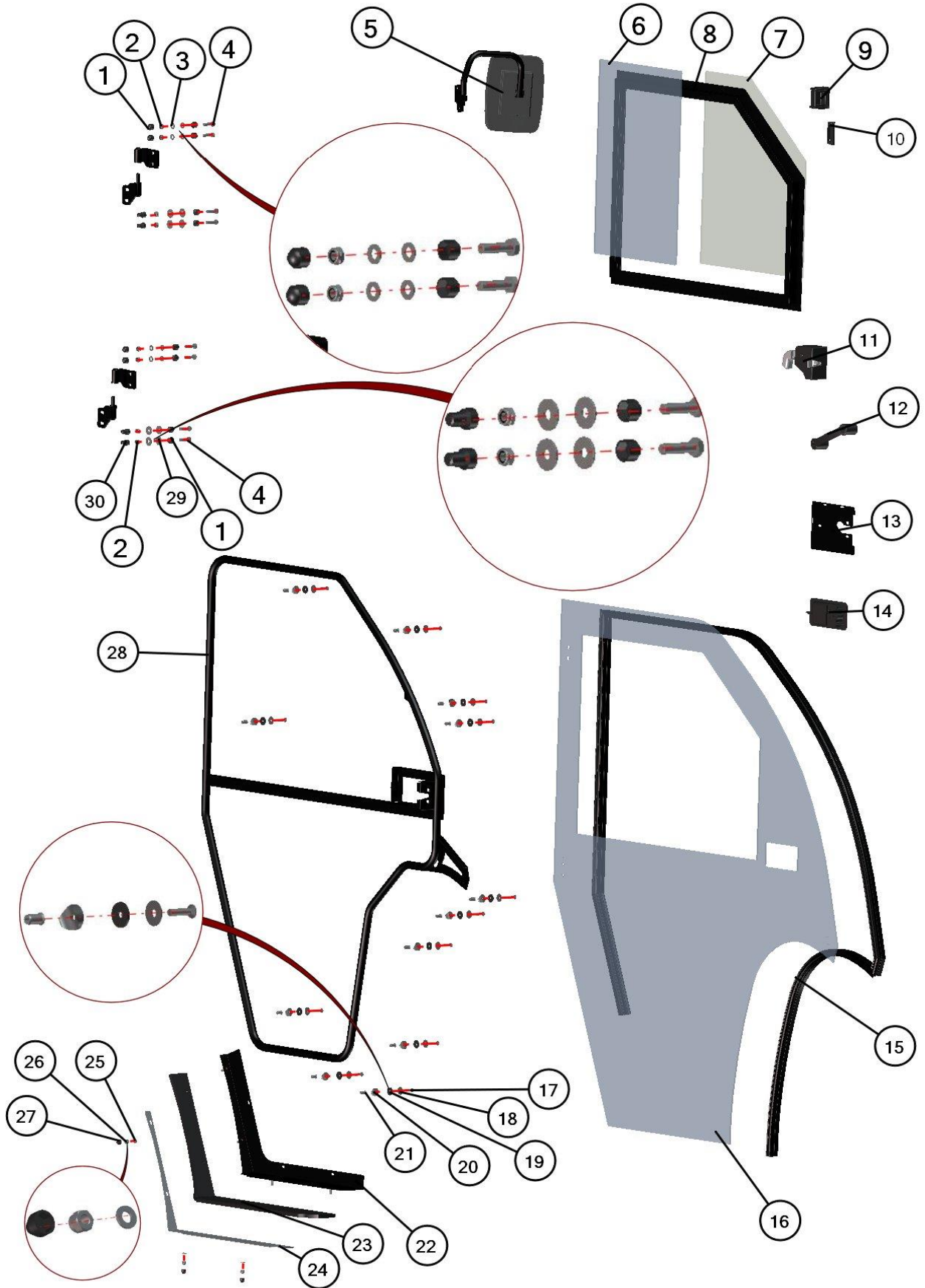

LEFT TABLE

Position	Catalogue no.	Description	Qty
1	001309	PLASTIC NUT COVER OK13	12
2	001388	SELF-LOCKING NUT M8	8
3	001387	WASHER 8	8
4	001411	SCREW M8x30	8
5	000994	LEFT REAR MIRROR	1
6	42S02U01-40-012	DOOR WINDOW SOLID POLY	1
7	42S02U01-40-013	DOOR GLASS MOWABLE	1
8	42S02U01-40-011	LEFT DOOR FRAME PVC	1
9	001700	GLASS LOCK	1
10	001762	GLASS STOP	1
11	001743	LEFT INNER DOOR LOCK	1
12	001703	HANDLE	1
13	42S02U01-40-015	DOOR LOCK MIDDLE COVER	1
14	000841	OUTER DOOR LOCK	1
15	002454^42S02U01S40	RUBBER PROFIL "SARAZIN SIDE"	1
16	42S02U01-40-001	DOOR PANEL POLY	1
17	002120	SCREW M6x25	12
18	001715	PLASTIC WASHER 6	12
19	001735	RUBBER WASHER 6	12
20	001736	SEAT WASHER 6	12
21	001397	RIVET NUT M6	12
22	42S02U01-40W002	LEFT BOOTOM LEDGE WELDED	1
23	42S02U01-40-009	LEFT BOTTOM LEDGE EPDM	1
24	42S02U01-40-010	LEFT BOTTOM LEDGE METAL	1
25	001426	WASHER 6	3
26	001392	SELF-LOCKING NUT M6	3
27	001348	PLASTIC NUT COVER OK10	3
28	42S02U01-40W001	LEFT DOOR FRAME WELDED	1
29	001407	WASHER 8 LARGE	8
30	001308	PLASTIC NUT COVER OK13 LONG	4







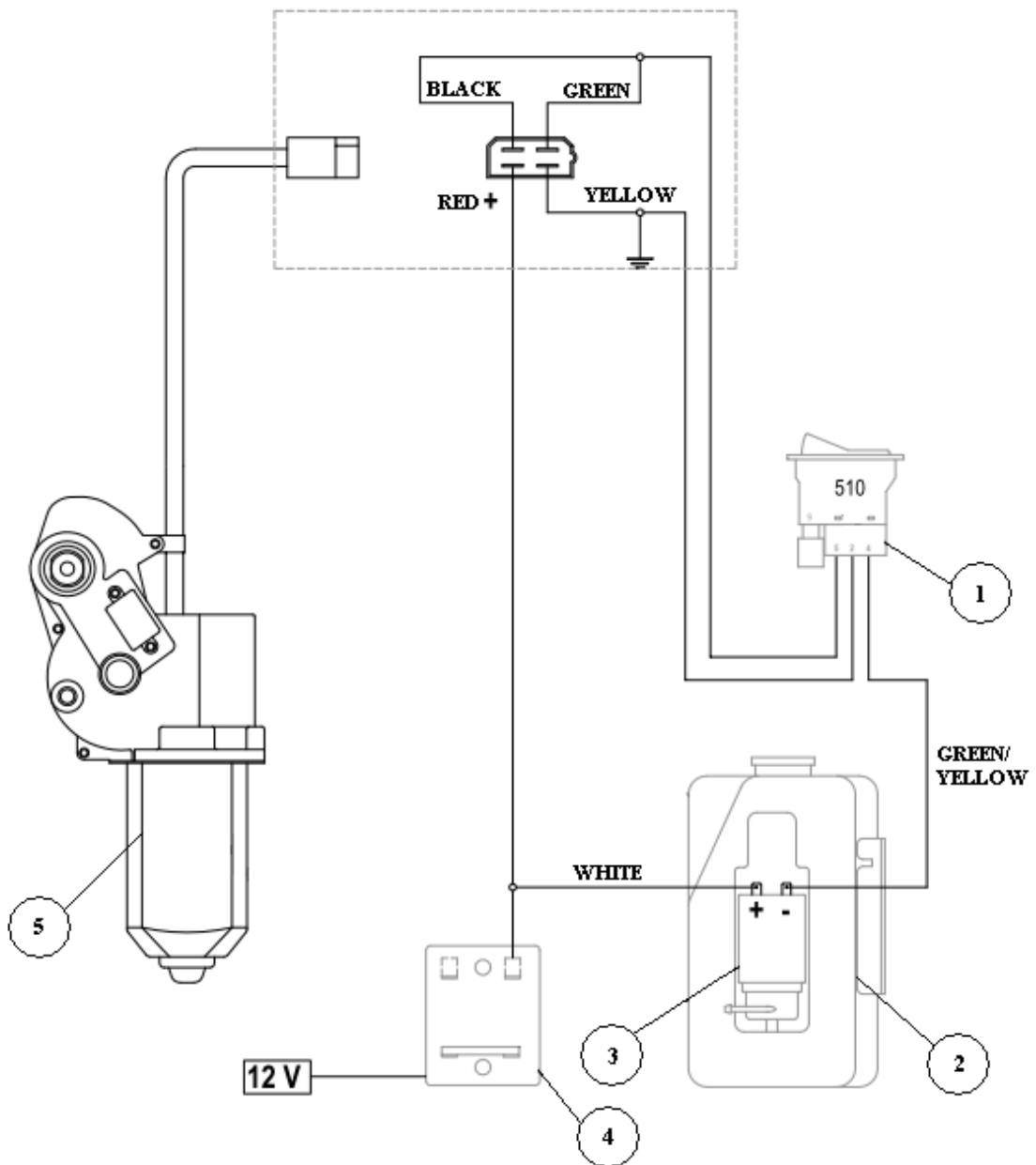

RIGHT TABLE

Position	Catalogue no.	Description	Qty
1	001309	PLASTIC NUT COVER OK13	12
2	001388	SELF-LOCKING NUT M8	8
3	001387	WASHER 8	8
4	001411	SCREW M8x30	8
5	000993	RIGHT REAR MIRROR	1
6	42S02U01-40-012	DOOR WINDOW SOLID POLY	1
7	42S02U01-40-013	DOOR GLASS MOWABLE	1
8	42S02U01-50-011	RIGHT DOOR FRAME PVC	1
9	001700	GLASS LOCK	1
10	001762	GLASS STOP	1
11	001744	RIGHT INNER DOOR LOCK	1
12	001703	HANDLE	1
13	42S02U01-50-015	RIGHT DOOR LOCK MIDDLE COVER	1
14	000841	OUTER DOOR LOCK	1
15	002454^42S02U01S40	RUBBER PROFIL "SARAZIN SIDE"	1
16	42S02U01-40-001	DOOR PANEL POLY	1
17	002120	SCREW M6x25	12
18	001715	PLASTIC WASHER 6	12
19	001735	RUBBER WASHER 6	12
20	001736	SEAT WASHER 6	12
21	001397	RIVET NUT M6	12
22	42S02U01-50W002	RIGHT BOOTOM LEDGE WELDED	1
23	42S02U01-50-009	RIGHT BOTTOM LEDGE EPDM	1
24	42S02U01-50-010	RIGHT BOTTOM LEDGE METAL	1
25	001426	WASHER 6	3
26	001392	SELF-LOCKING NUT M6	3
27	001348	PLASTIC NUT COVER OK10	3
28	42S02U01-50W001	RIGHT DOOR FRAME WELDED	1
29	001407	WASHER 8 LARGE	8
30	001308	PLASTIC NUT COVER OK13 LONG	4

ELECTROINSTALLATION

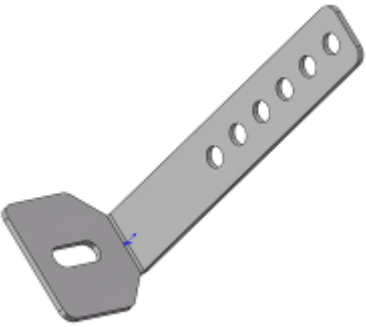

Position	Catalogue no.	Description	Qty
1	000968	SWITCH WIPER /WASHER /OFF	1
2	000885	WASHER TANK	1
3	001576	WASHER MOTOR	1
4	001652	FUSE BOX 2x1	1
5	001763	WIPER MOTOR 12V	1
6	001775	WASHER HOSE CONNECTOR "L"	1
7	00-01-001	WASHER TANK HOLDER	1
8	42S02U01-01M001	HARNES WIPER	1
9	42S02U01-03M001	HARNES WASHER	1

		
Position : 1	Position : 2	Position : 3
Catalogue no.: 000968	Catalogue no.: 000885	Catalogue no.: 001576
		
Position : 4	Position : 5	Position : 6
Catalogue no.: 001652	Catalogue no.: 001763	Catalogue no.: 001775
		
Position : 7	Position : 8	Position : 9
Catalogue no.: 00-01-001	Catalogue no.: 42S02U01-01M001	Catalogue no.: 42S02U01-03M001