

HardCabs

A DFK AMERICA COMPANY

SPARE - PARTS CATALOGUE

CF Moto **UFORCE 800EX**



CAB PREVIEW

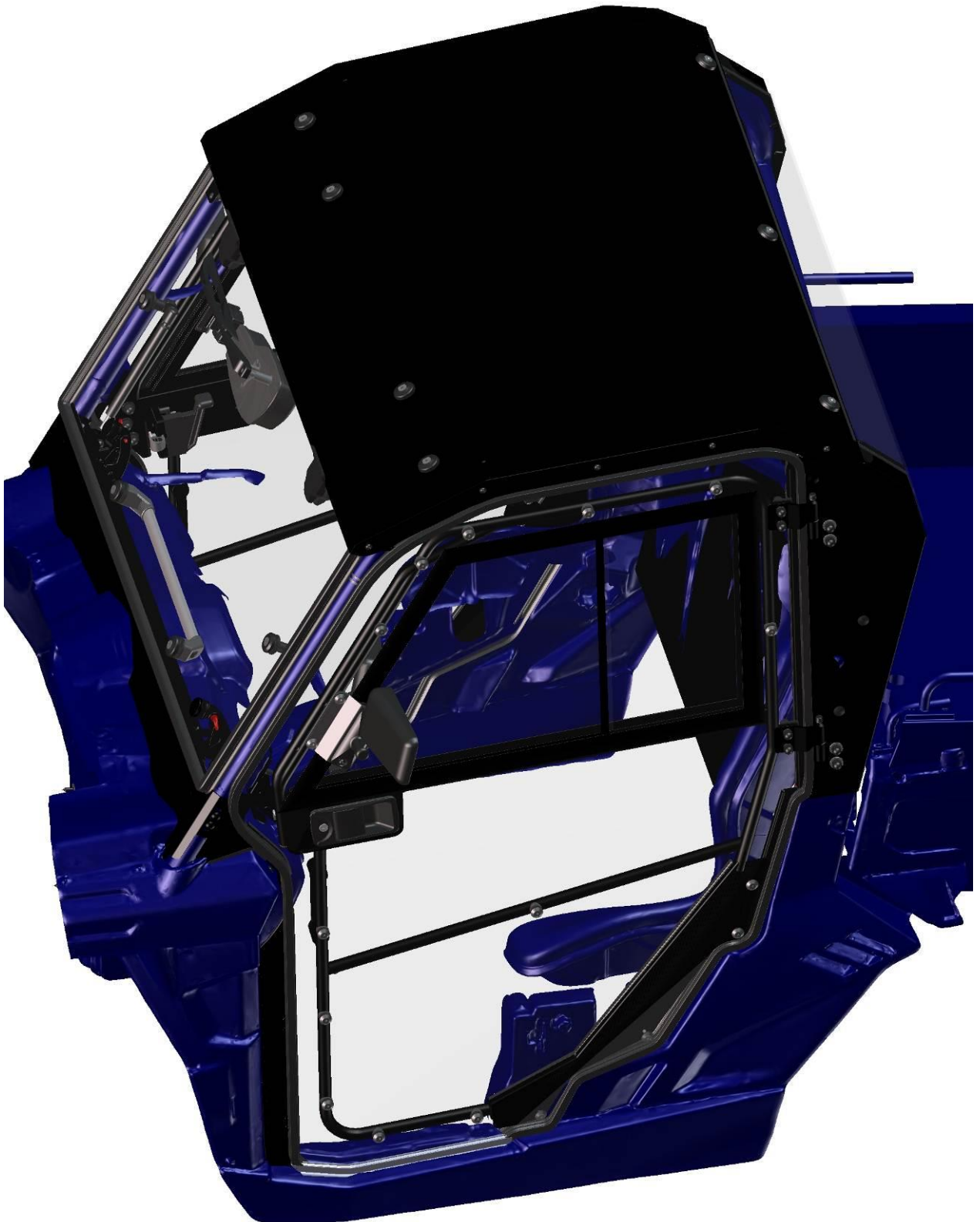

2



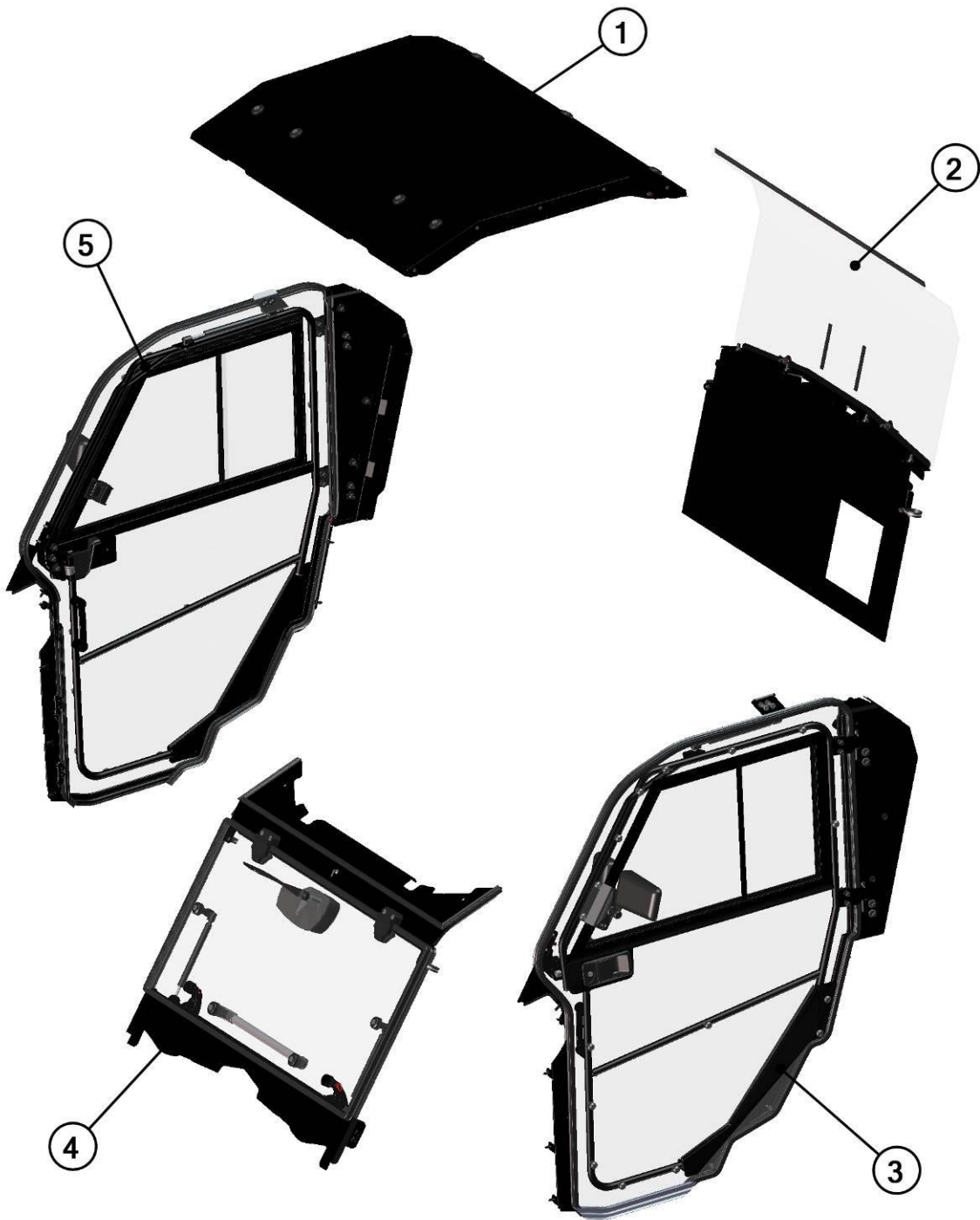

4

Position	Catalogue no.	Description	Qty	Price
1	64S01U01S30	ROOF	1	
2	64S01U01S20	REAR PANEL	1	
3	64S01U01S40	LEFT DOOR	1	
4	64S01U01S10	FRONT PANEL MOVABLE	1	
5	64S01U01S50	RIGHT DOOR	1	

FRONT PANEL



5

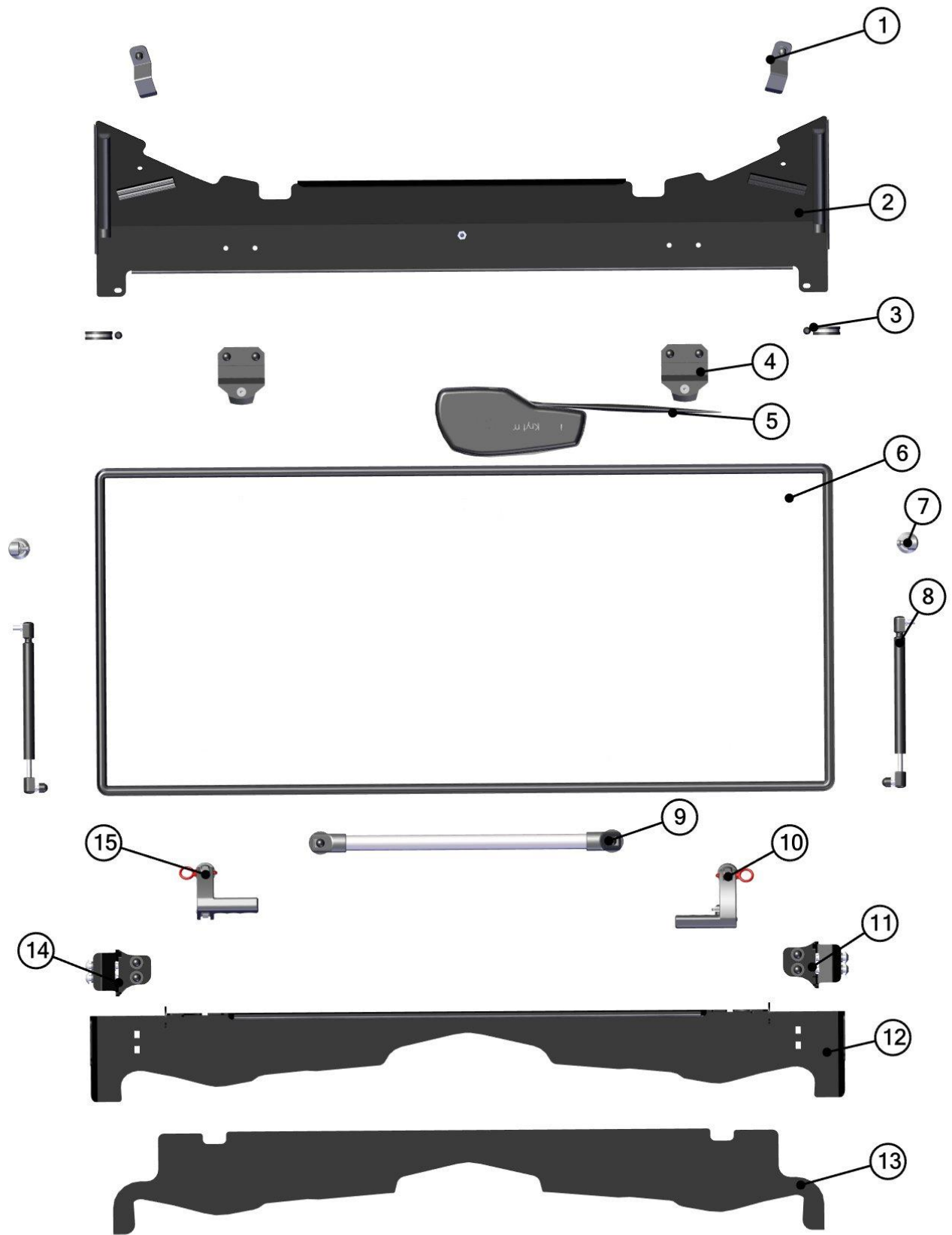

6

Position	Catalogue no.	Description	Qty	Price
1	64S01U01-10M006	FRONT UPPER LEDGE HOLDER ASSEMBLY	2	
2	64S01U01-10W001	FRONT UPPER LEDGE WELDED	1	
3	64S01U01-10M012	FRONT UPPER LEDGE FIXING ASSEMBLY	2	
4	00-10M012	PLASTIC HINGE ASSEMBLY	2	
5	64S01U01S01	WIPER ASSEMBLY	1	
6	64S01U01-10M003	FRONT GLASS WITH SEALING	1	
7	00-20M005	GAS SPRING HOLDER	2	
8	64S01U01-10M013	GAS SPRING ASSEMBLY	2	
9	00-113U-M001	FRONT HANDLE	1	
10	64S01U01-10M007	RIGHT FRONT GLASS LOCK ASSEMBLY	1	
11	64S01U01-10M008	RIGHT FRONT BOTTOM LEDGE HOLDER ASSEMBLY	1	
12	64S01U01-10W002	FRONT BOTTOM LEDGE WELDED	1	
13	64S01U01-10-011	FRONT BOTTOM LEDGE EPDM	1	
14	64S01U01-10M010	LEFT FRONT BOTTOM LEDGE HOLDER ASSEMBLY	1	
15	64S01U01-10M009	LEFT FRONT GLASS LOCK ASSEMBLY	1	

REAR PANEL

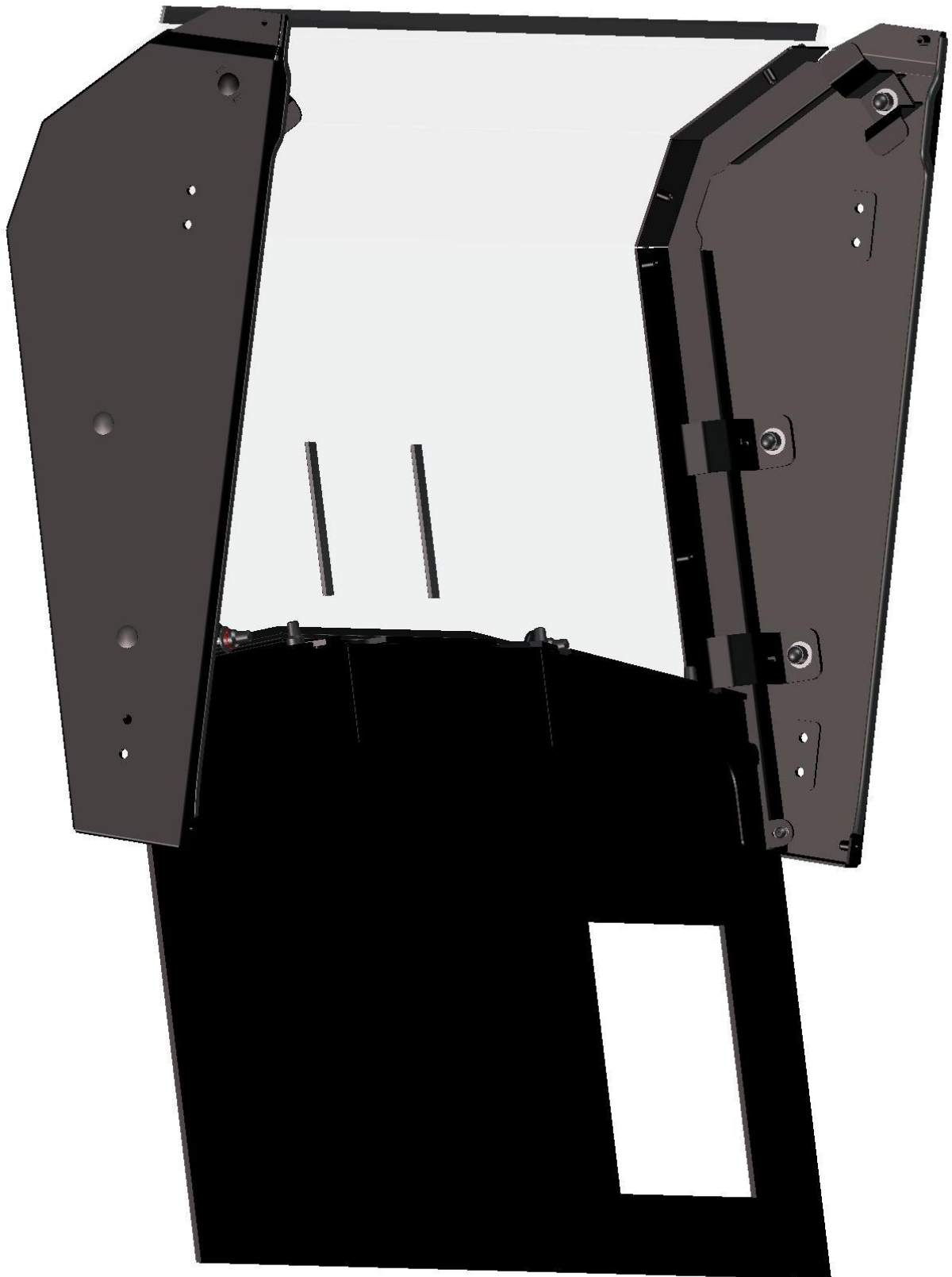

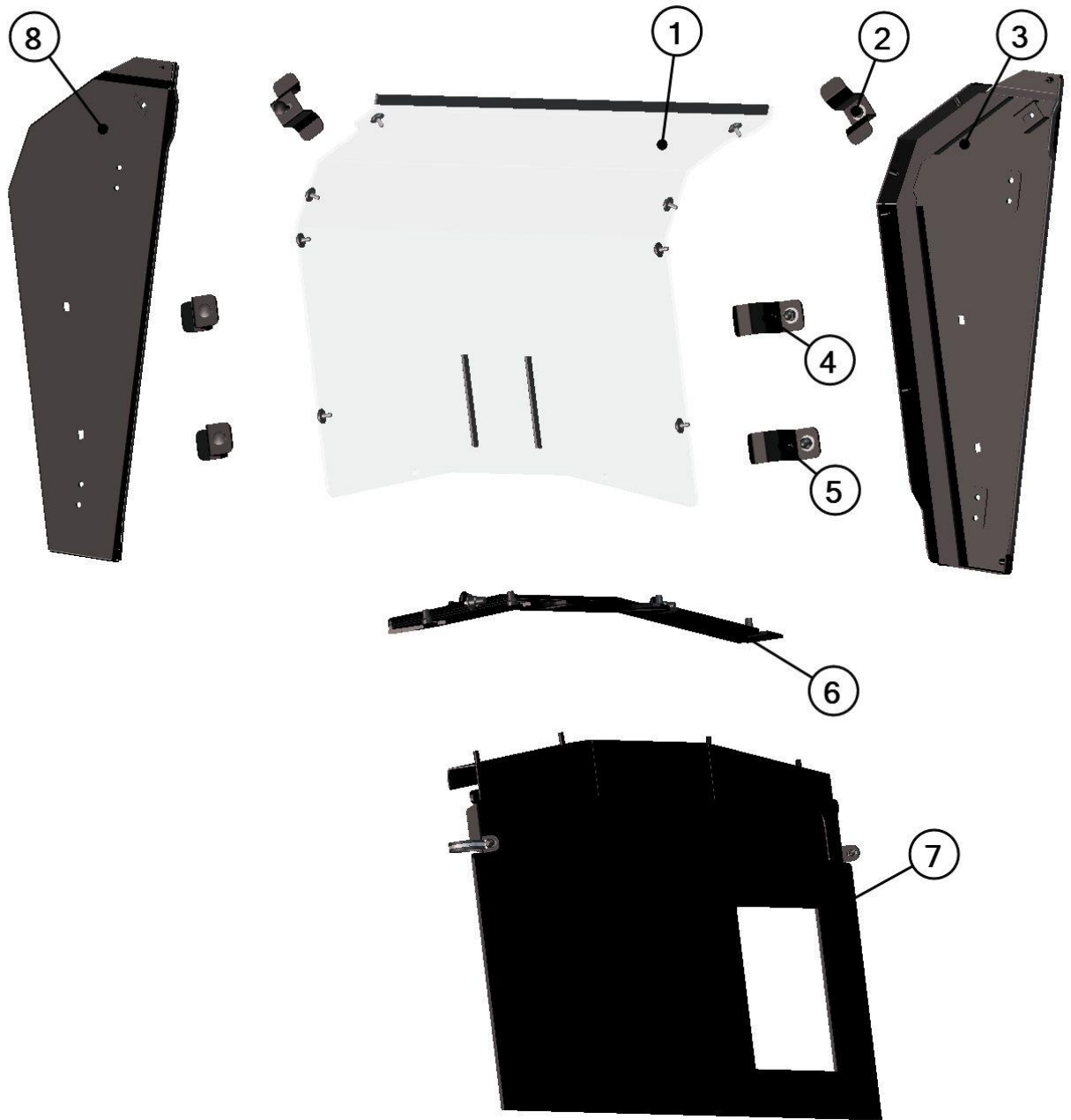

Position	Catalogue no.	Description	Qty	Price
1	64S01U01-20M001	REAR WINDOW ASSEMBLY	1	
2	64S01U01-50M003	UPPER DOOR BASE HOLDER ASSEMBLY	2	
3	64S01U01-40W001	LEFT DOOR BASE WELDED ASSEMBLY	1	
4	64S01U01-50M016	MIDDLE DOOR BASE HOLDER ASSEMBLY	2	
5	64S01U01-50M002	BOTTOM DOOR BASE HOLDER ASSEMBLY	2	
6	64S01U01-20M013	REAR CENTRAL LEDGE ASSEMBLY	1	
7	64S01U01-20M005	REAR BOTTOM ASSEMBLY	1	
8	64S01U01-40W001	LEFT DOOR BASE WELDED ASSEMBLY	1	

ROOF

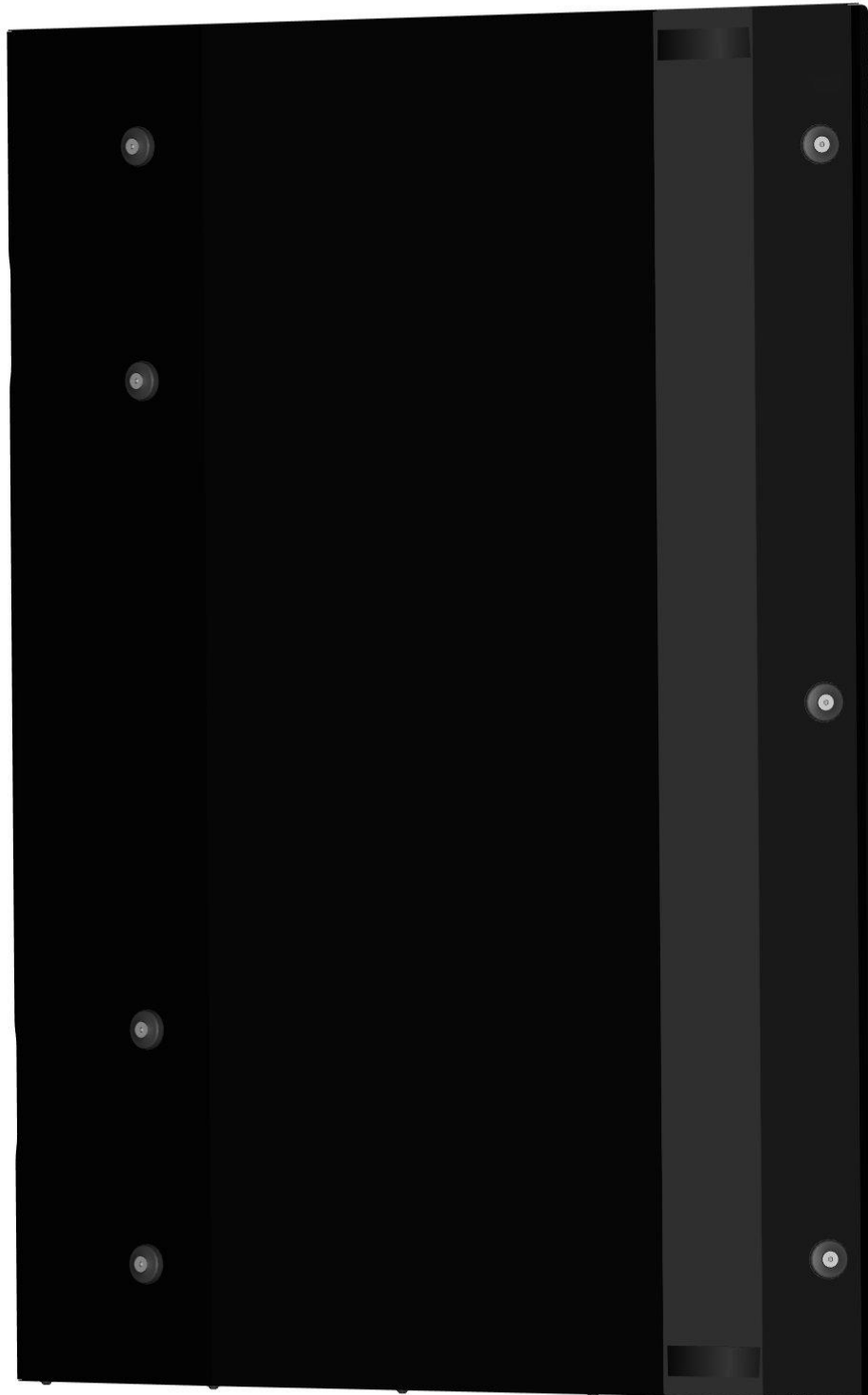

10

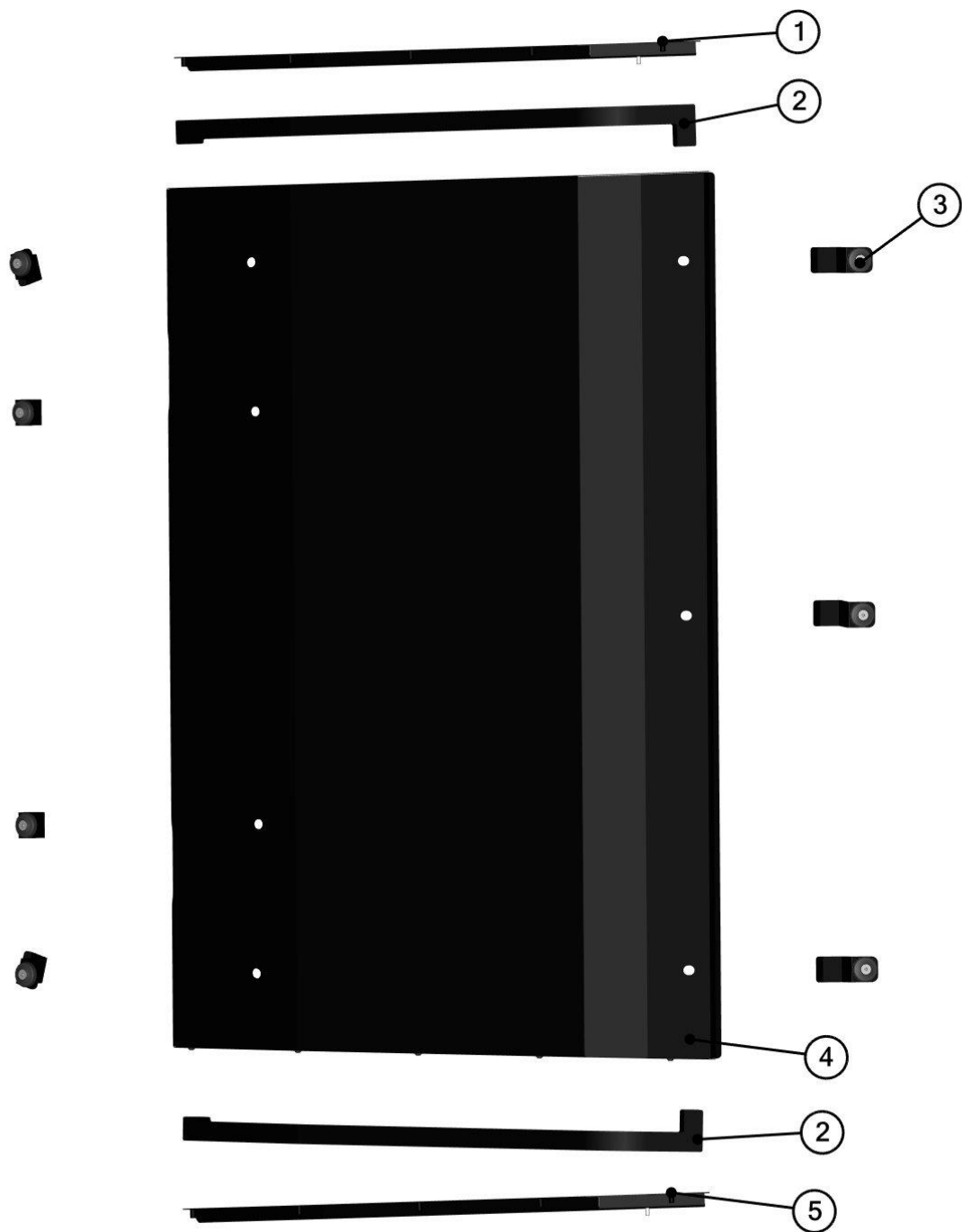

Position	Catalogue no.	Description	Qty	Price
1	64S01U01-30M001	RIGHT ROOF LEDGE ASSEMBLY	1	
2	64S01U01-30-009	SEALING "PUR"	2	
3	64S01U01-30M002	ROOF HOLDER ASSEMBLY	7	
4	64S01U01-30M004	ROOF PANEL ASSEMBLY	1	
5	64S01U01-30M003	LEFT ROOF LEDGE ASSEMBLY	1	

LEFT DOOR + RIGHT DOOR



12

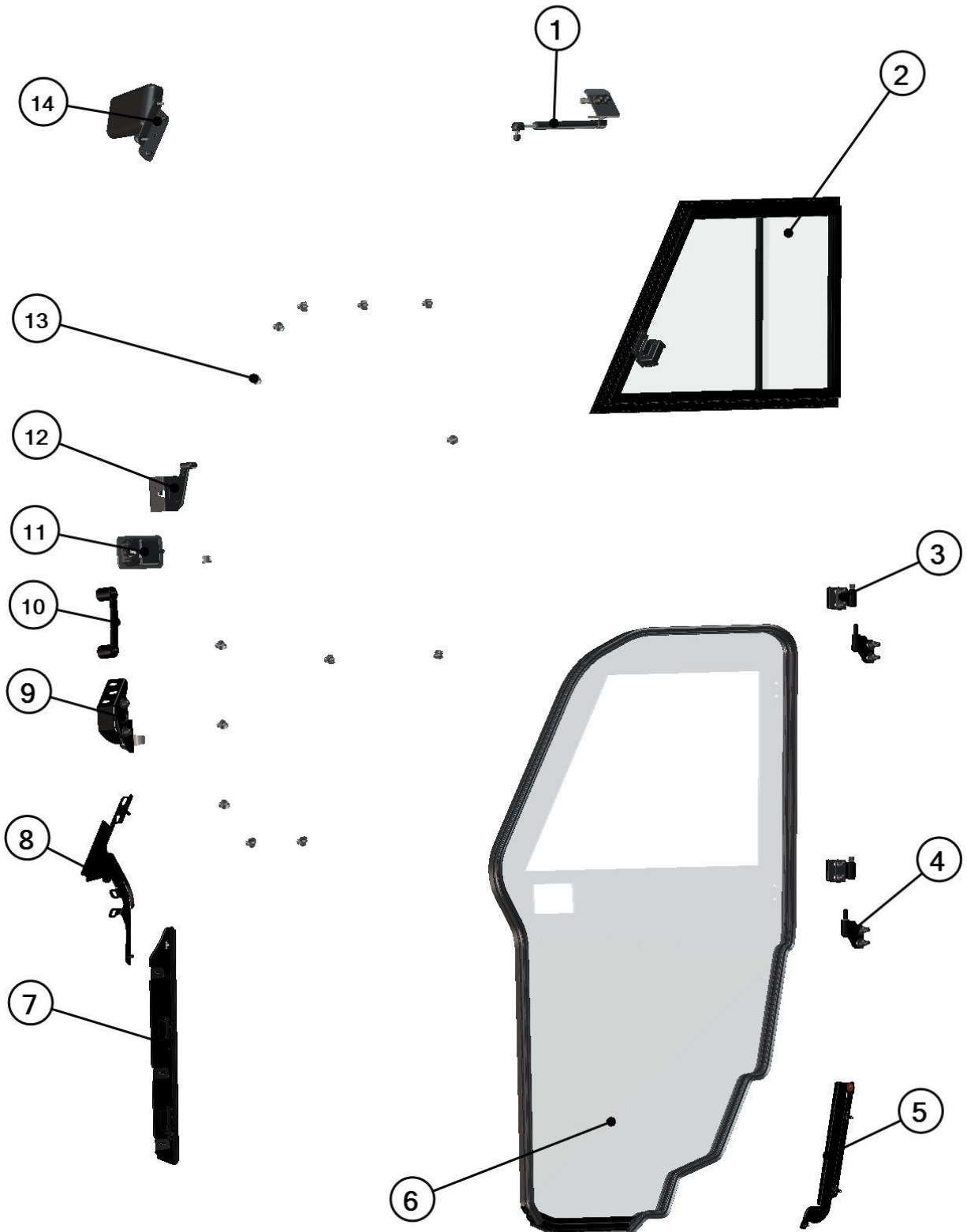

RIGHT TABLE

Position	Catalogue no.	Description	Qty	Price
1	64S01U01-50M009	RIGHT GAS SPRING ASSEMBLY	1	
2	64S01U01-50M008	RIGHT WINDOW ASSEMBLY	1	
3	00-105U-M004	RIGHT DOOR HINGE	2	
4	00-105U-M002	RIGHT FRAME HINGE	2	
5	64S01U01-50M017	RIGHT DOOR REAR LEDGE	1	
6	64S01U01-50M006	RIGHT DOOR PANEL	1	
7	64S01U01-50M005	RIGHT DOOR BOTTOM FRONT LEDGE	1	
8	64S01U01-50W005	RIGHT DOOR UPPER FRONT LEDGE	1	
9	64S01U01-50M013	RIGHT DOOR STOP ASSEMBLY	1	
10	001703	DOOR HANDLE	1	
11	000841	OUTER DOOR LOCK	1	
12	001741	RIGHT INNER DOOR LOCK	1	
13	64S01U01-50M010	POLYCARBONATE FIXING ASSEMBLY	12	
14	64S01U01-50M014	RIGHT MIRROR ASSEMBLY	1	







LEFT TABLE



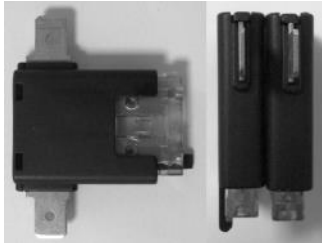

Position	Catalogue no.	Description	Qty	Price
1	64S01U01-40M009	LEFT GAS SPRING ASSEMBLY	1	
2	64S01U01-40M008	LEFT WINDOW ASSEMBLY	1	
3	00-105U-M004	LEFTT DOOR HINGE	2	
4	00-105U-M002	LEFT FRAME HINGE	2	
5	64S01U01-40M017	LEFT DOOR REAR LEDGE	1	
6	64S01U01-40M006	LEFT DOOR PANEL	1	
7	64S01U01-40M005	LEFT DOOR BOTTOM FRONT LEDGE	1	
8	64S01U01-40W005	LEFT DOOR UPPER FRONT LEDGE	1	
9	64S01U01-40M013	LEFT DOOR STOP ASSEMBLY	1	
10	001703	DOOR HANDLE	1	
11	000841	OUTER DOOR LOCK	1	
12	001742	LEFT INNER DOOR LOCK	1	
13	64S01U01-50M010	POLYCARBONATE FIXING ASSEMBLY	12	
14	64S01U01-40M014	LEFT MIRROR ASSEMBLY	1	

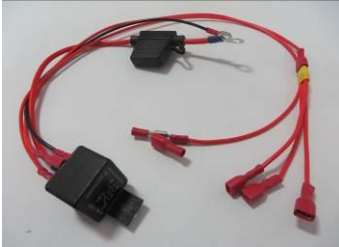

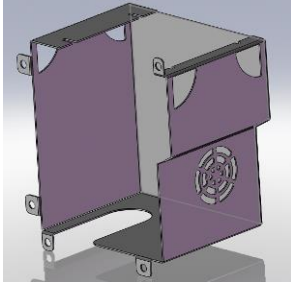

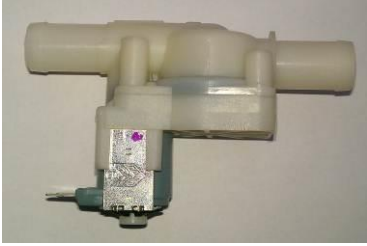

ELECTROINSTALLATION

Position	Catalogue no.	Description	Qty	Price
1	000968	SWITCH WIPER /WASHER /OFF	1	
2	000885	WASHER TANK	1	
3	001576	WASHER MOTOR	1	
4	001652	FUSE BOX 2x1	1	
5	002764	WIPER MOTOR 12V	1	
6	64S01U01-01M005	RELAY HARNESS	1	
7	64S01U01-01M002	WIPER HARNESS	1	
8	002678	HEATER 12V	1	
9	64S01U01-02W001	HEATER HOLDER WELDED	1	
10	64S01U01-02M001	HEATER HARNESS	1	
11	002386	EL. VALVE	1	
12	002795	AIR HOSE PVC	1	
13	000896	HEATER HOSE 16mm	1	
14	002491	AIR VALVE	1	
15	002391	EL. VALVE SWITCH	1	
16	002702	HEATER SWITCH	1	
17	002502	"Y" COUPLING 25-25-16	2	
18	002503	"Y" COUPLING 21-21-16	2	
19	002643	TIGHTENING STRAP 21-38mm	4	
20	001368	TIGHTENING STRAP 40-60 ZB	4	
21	001367	TIGHTENING STRAP 12-22 ZB	10	
22	002018	HOSE BUSHING	1	
23	002863	AIR VENT	2	
24	001571	BENDED HOSE	2	
25	64S01U01-03M001	WASHER HARNESS	1	
26	002705	ALUMINIUM TAPE	1	

15

		
<p>Position : 1</p> <p>Catalogue no.: 000968</p>	<p>Position : 2</p> <p>Catalogue no.: 000885</p>	<p>Position : 3</p> <p>Catalogue no.: 001576</p>
		
<p>Position : 4</p> <p>Catalogue no.: 001652</p>	<p>Position : 5</p> <p>Catalogue no.: 002764</p>	<p>Position : 6</p> <p>Catalogue no.: 64S01U01-01M005</p>
		
<p>Position : 7</p> <p>Catalogue no.: 64S01U01-01M002</p>	<p>Position : 8</p> <p>Catalogue no.: 002678</p>	<p>Position : 9</p> <p>Catalogue no.: 64S01U01-02W001</p>

		
Position : 10	Position : 11	Position : 12
Catalogue no.: 64S01U01-02M001	Catalogue no.: 002386	Catalogue no.: 002795
		
Position : 13	Position : 14	Position : 15
Catalogue no.: 000896	Catalogue no.: 02491	Catalogue no.: 002391
		
Position : 16	Position : 17	Position : 18
Catalogue no.: 002702	Catalogue no.: 002502	Catalogue no.: 002503

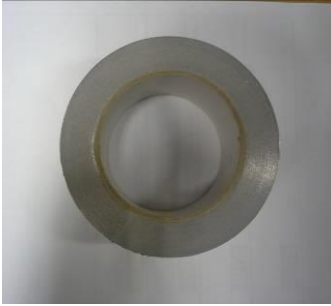
		
Position : 19	Position : 20	Position : 21
Catalogue no.: 002643	Catalogue no.: 001368	Catalogue no.: 001367
		
Position : 22	Position : 23	Position : 24
Catalogue no.: 002018	Catalogue no.: 002863	Catalogue no.: 001571
		
Position : 25	Position : 26	
Catalogue no.: 64S01U01-03M001	Catalogue no.: 002705	