

HardCabs



SPARE - PARTS CATALOG

CF MOTO
ZFORCE 800EX

CAB PREVIEW

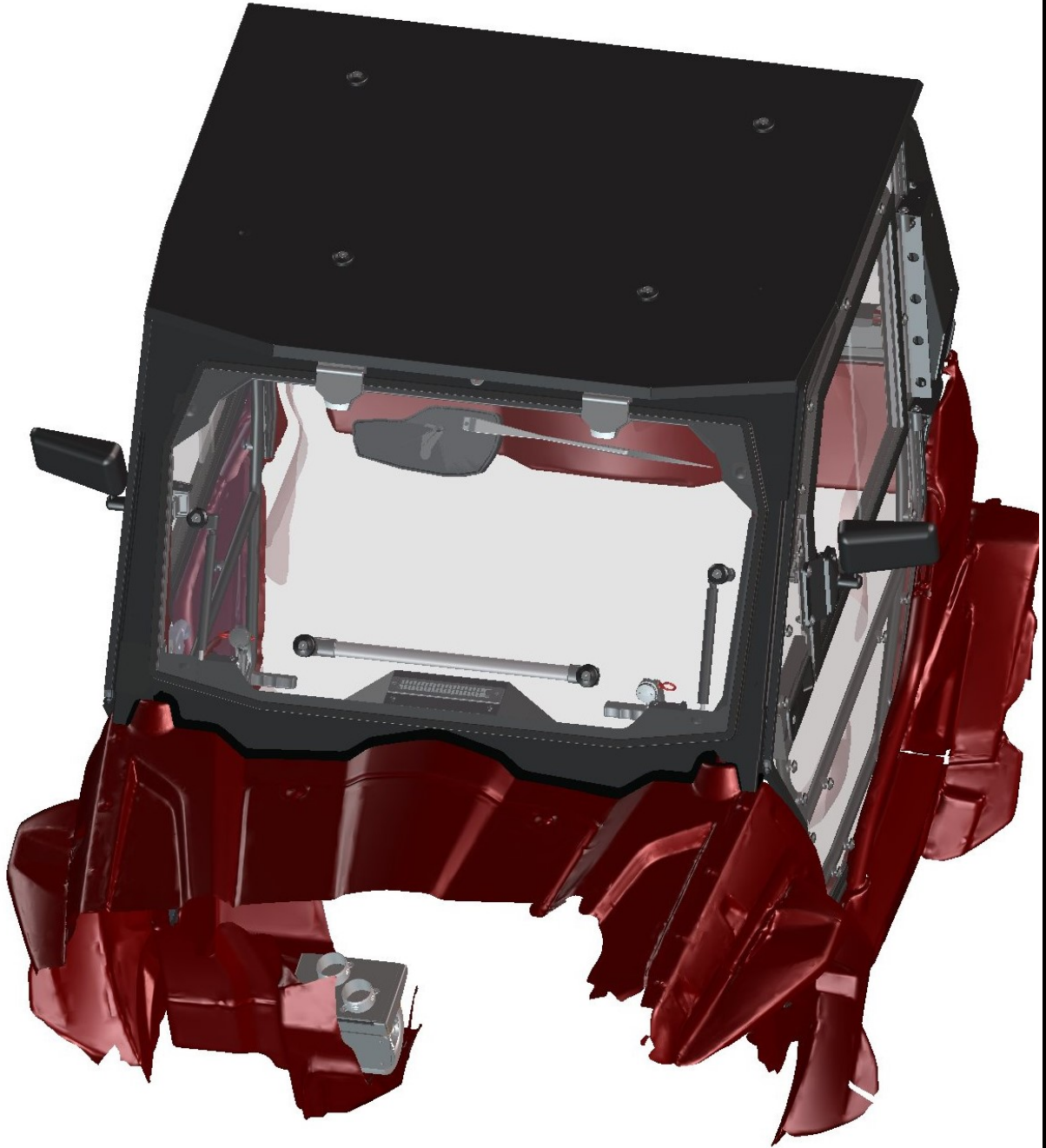

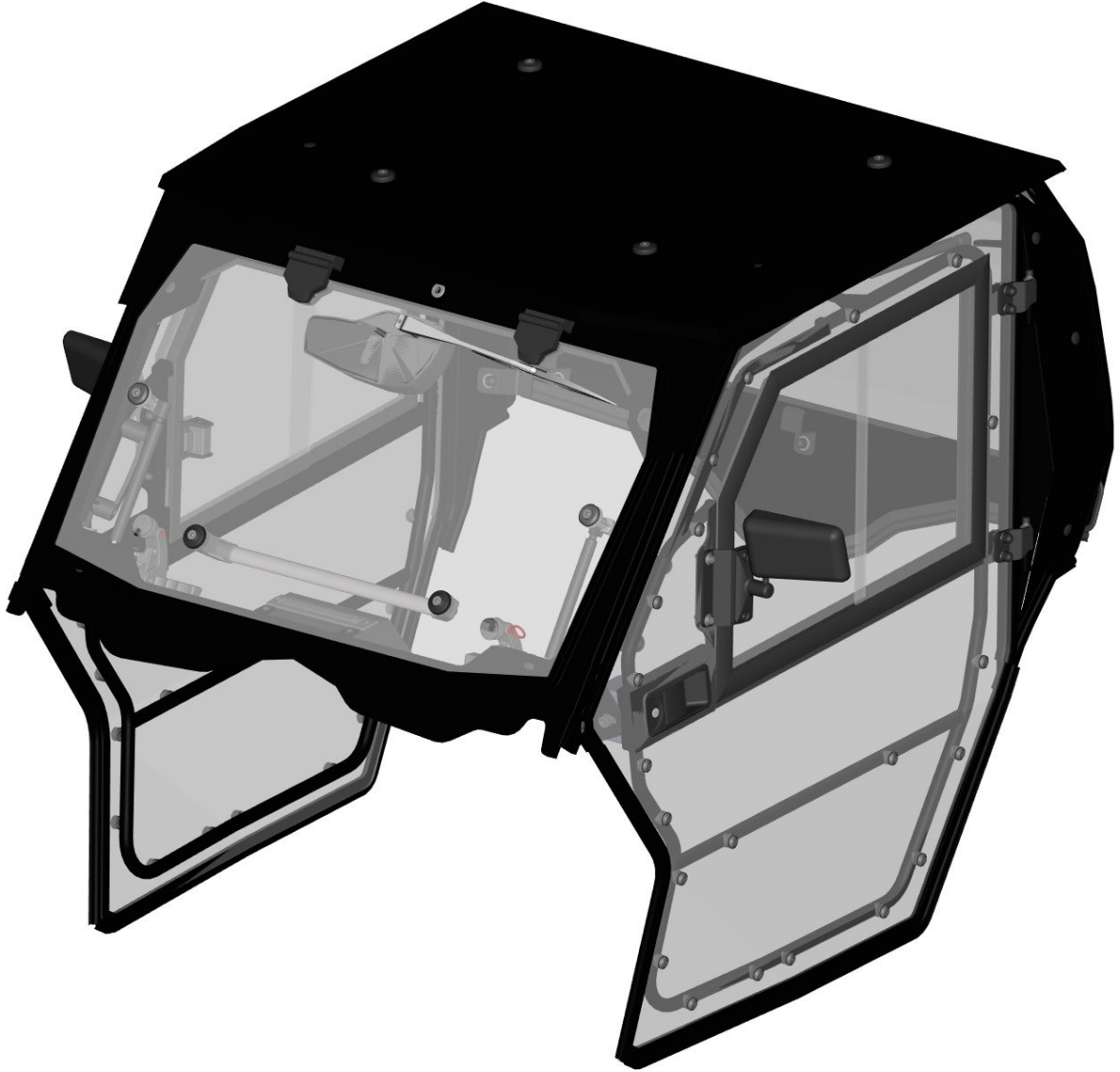

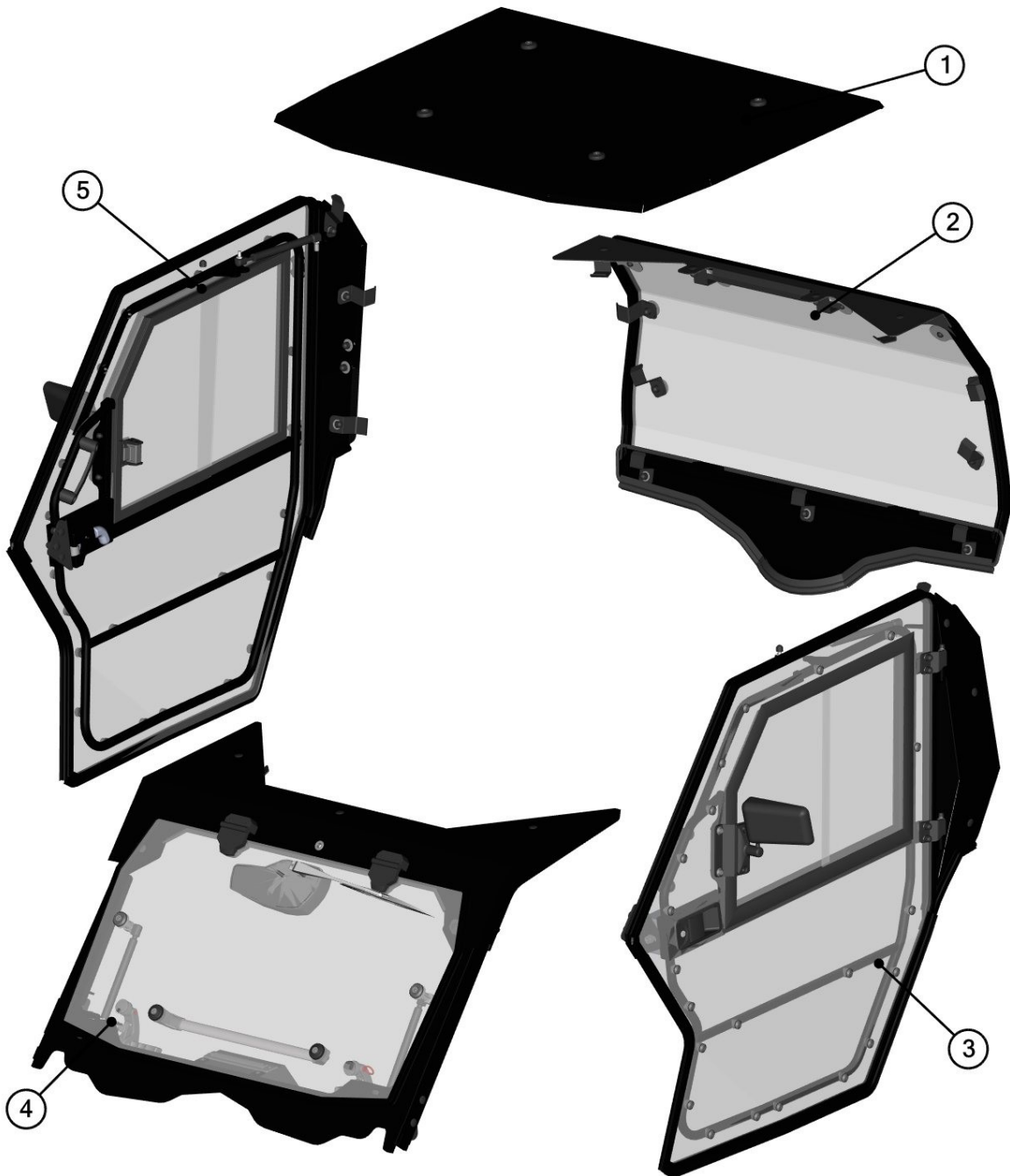

Position	Catalogue no.	Description	Qty	Price
1	64S02U01S30	ROOF	1	
2	64S02U01S20	REAR PANEL	1	
3	64S02U01S40	LEFT DOOR	1	
4	64S02U01S10	FRONT PANEL	1	
5	64S02U01S50	RIGHT DOOR	1	

FRONT PANEL



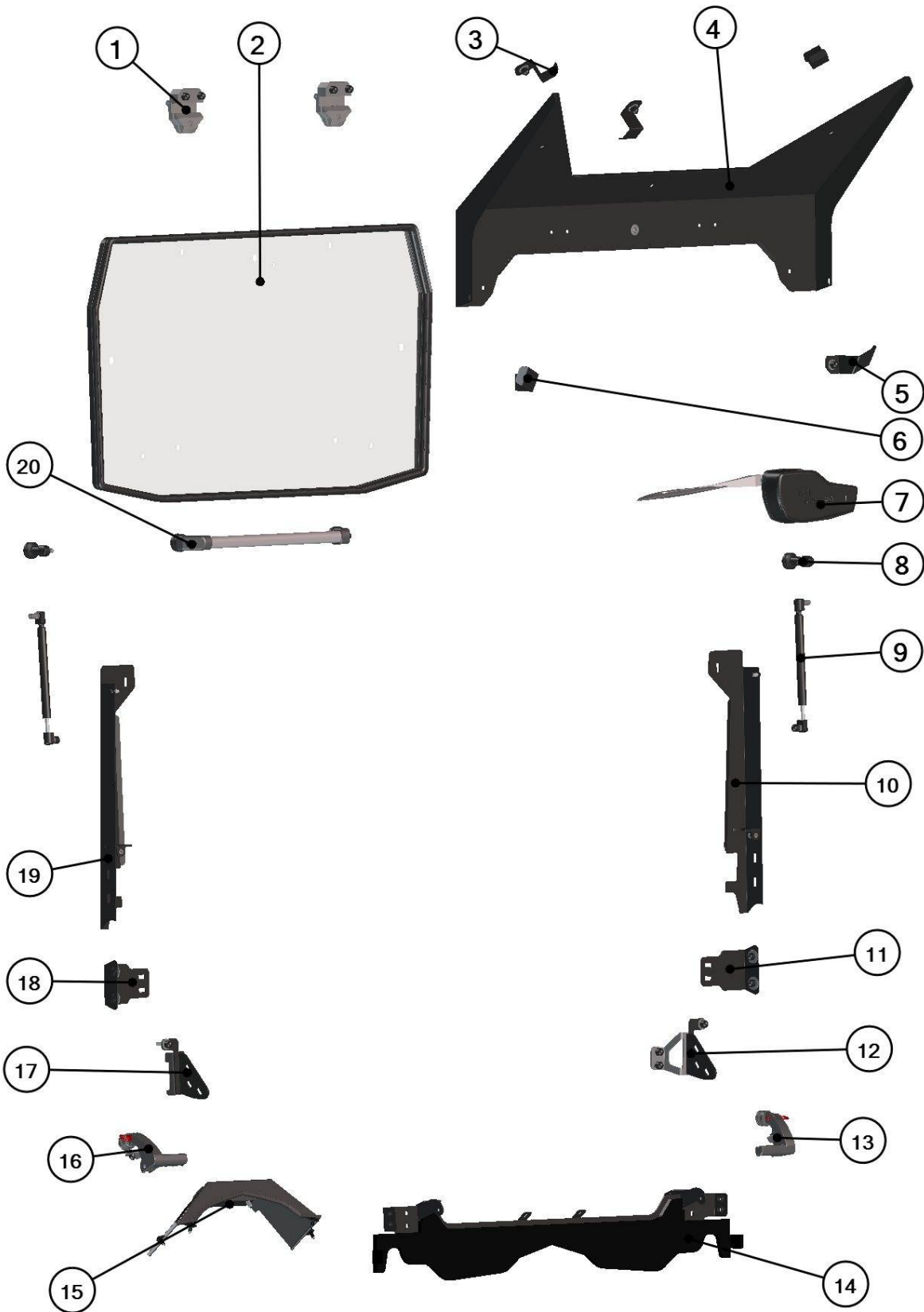

Position	Catalogue no.	Description	Qty	Price
1	00-10M012	PLASTIC HINGE ASSEMBLY	2	
2	64S02U01-10M004	FRONT WINDOW WITH SEALING	1	
3	64S02U01-10M002	FRONT UPPER HOLDER ASSEMBLY	3	
4	64S02U01-10M016	FRONT UPPER LEDGE ASSEMBLY	1	
5	64S02U01-10M011	RIGHT FRONT HOLDER	1	
6	64S02U01-10M010	LEFT FRONT HOLDER	1	
7	64S02U01-10M012	FRONT WIPER ASSEMBLY	1	
8	001693	GAS SPRING HOLDER ASSEMBLY	2	
9	00-40M004	GAS SPRING ASSEMBLY	2	
10	64S02U01-50M016	FRONT RIGHT LEDGE ASSEMBLY	1	
11	64S02U01-50M015	FRONT RIGHT LEDGE HOLDER ASSEMBLY	1	
12	64S02U01-10M008	RIGHT BOTTOM LEDGE HOLDER ASSEMBLY	1	
13	64S02U01-10M013	RIGHT GLASS LOCK ASSEMBLY	1	
14	64S02U01-10M015	FRONT BOTTOM LEDGE ASSEMBLY	1	
15	64S02U01-02M001	HEATER AIR VENT ASSEMBLY	1	
16	64S02U01-10M014	LEFT GLASS LOCK ASSEMBLY	1	
17	64S02U01-10M007	LEFT BOTTOM LEDGE HOLDER ASSEMBLY	1	
18	64S02U01-40M015	FRONT LEFT LEDGE HOLDER ASSEMBLY	1	
19	64S02U01-40M016	FRONT LEFT LEDGE ASSEMBLY	1	
20	00-113U-M001	WINDOW HANDLE ASSEMBLY	1	

REAR PANEL



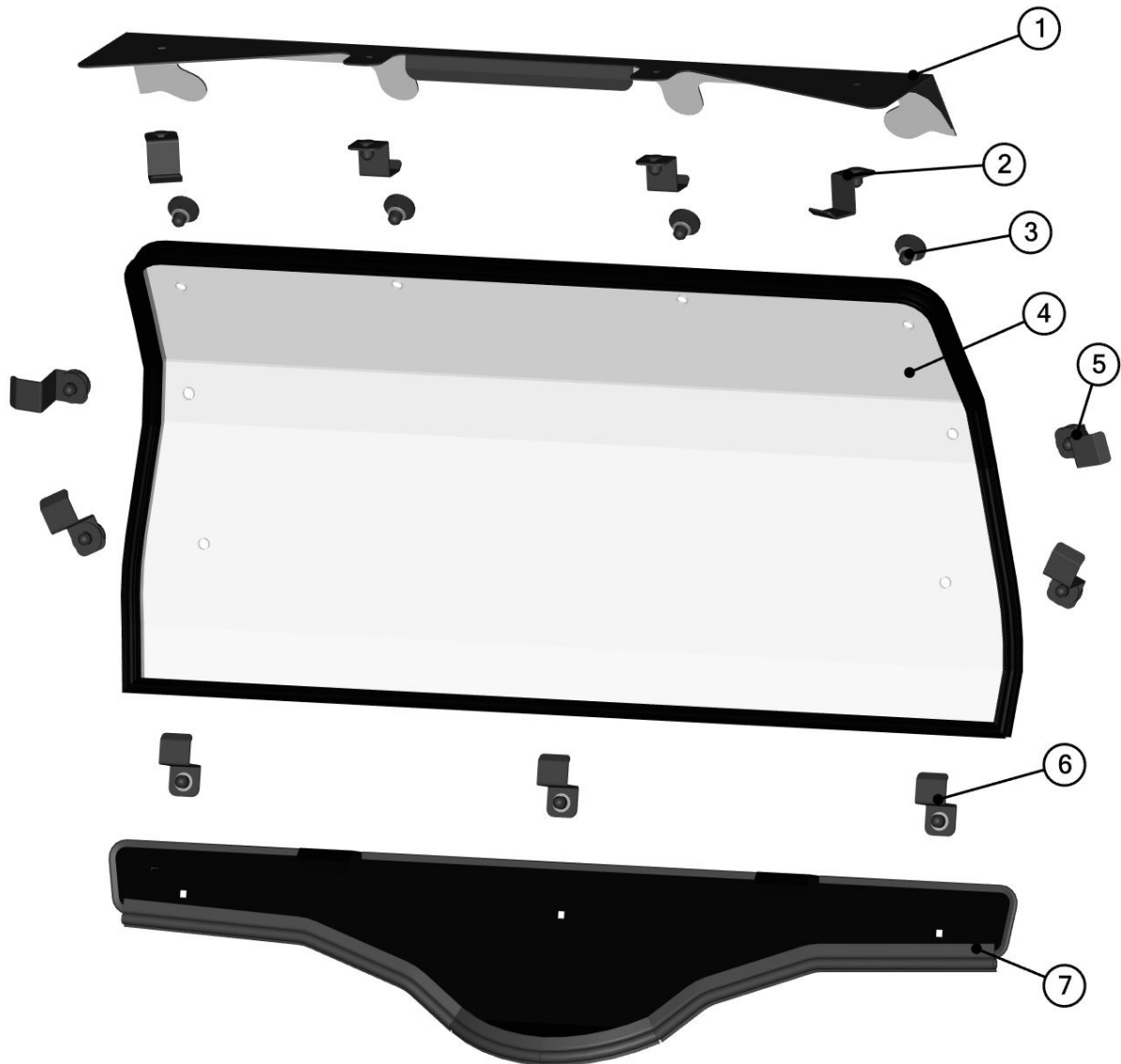

Position	Catalogue no.	Description	Qty	Price
1	64S02U01-20M009	REAR UPPER LEDGE ASSEMBLY	1	
2	64S02U01-10M002	REAR UPPER LEDGE HOLDER ASSEMBLY	4	
3	00-00M001	POLYCARBONATE FIXING ASSEMBLY	4	
4	64S02U01-20M002	REAR GLASS WITH SEALING	1	
5	64S02U01-20M005	REAR GLASS HOLDER ASSEMBLY	4	
6	64S02U01-20M004	REAR BOTTOM LEDGE HOLDER ASSEMBLY	3	
7	64S02U01-20M008	REAR BOTTOM LEDGE ASSEMBLY	1	

ROOF

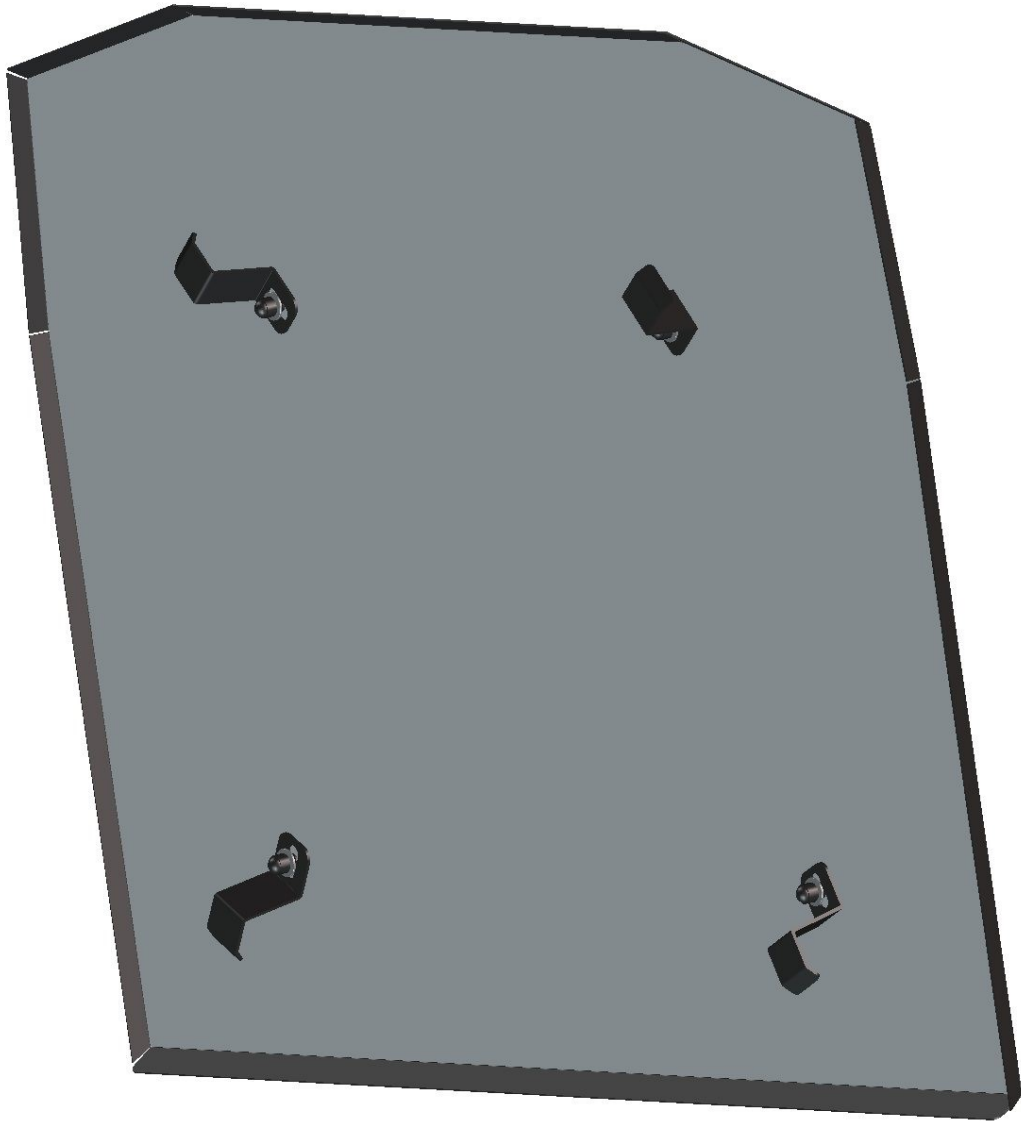

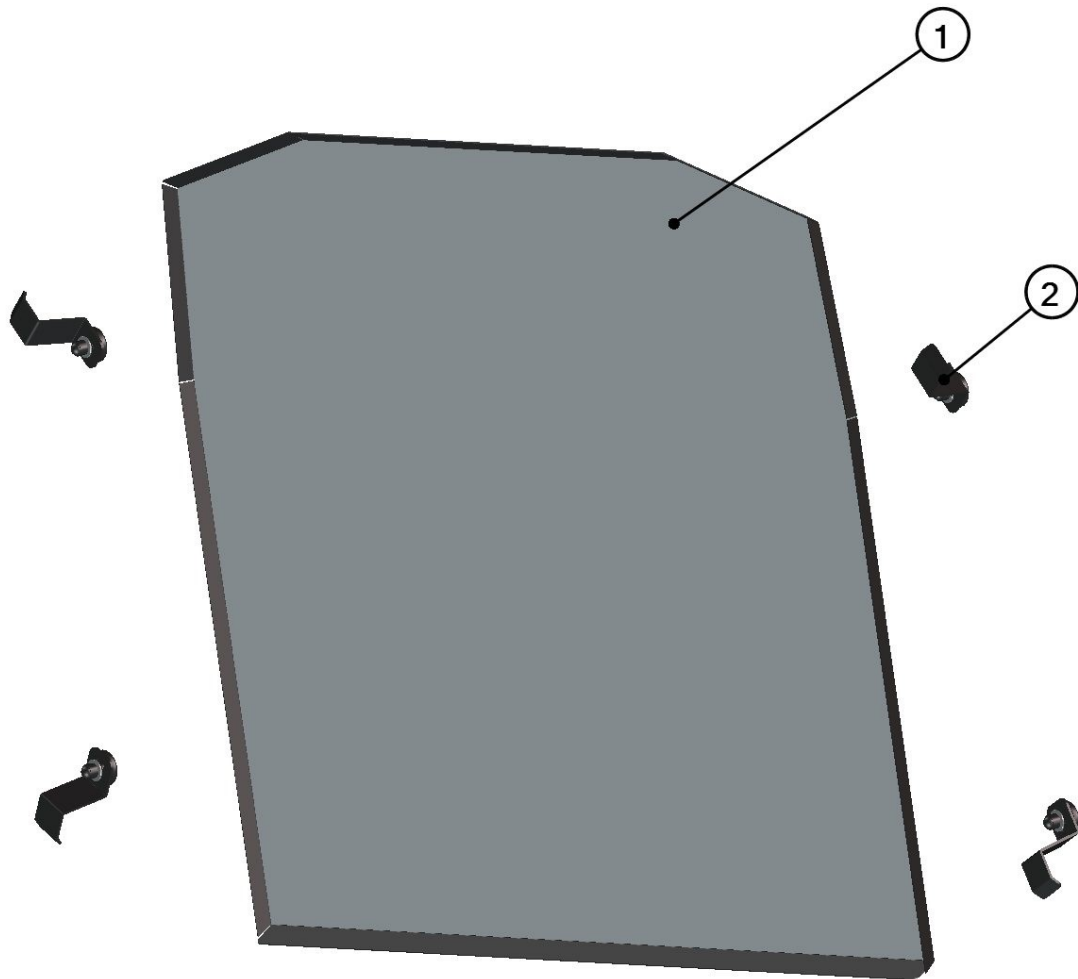

Position	Catalogue no.	Description	Qty	Price
1	64S02U01-30M002	ROOF PANEL ASSEMBLY	1	
2	64S02U01-30M001	ROOF HOLDER ASSEMBLY	4	

LEFT DOOR + RIGHT DOOR



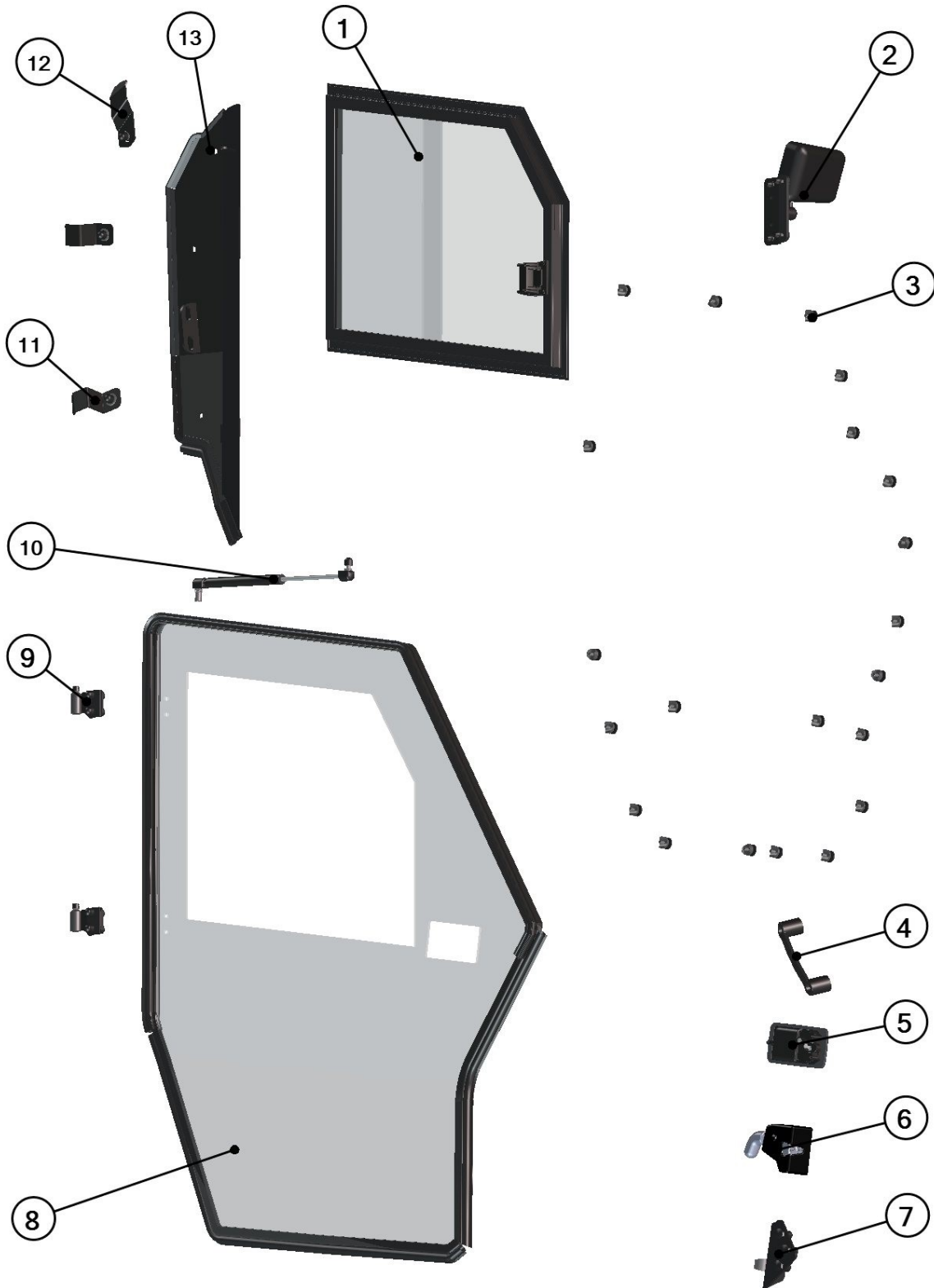

LEFT TABLE









Position	Catalogue no.	Description	Qty	Price
1	64S02U01-40M004	LEFT WINDOW ASSEMBLY	1	
2	64S02U01-40M012	LEFT MIRROR ASSEMBLY	1	
3	00-00M019	POLYCARBONATE FIXING ASSEMBLY	21	
4	001703	DOOR HANDLE	1	
5	000841	OUTER DOOR LOCK	1	
6	001743	LEFT INNER DOOR LOCK	1	
7	64S02U01-40M003	LEFT DOOR STOP ASSMEBLY	1	
8	64S02U01-40M008	LEFT DOOR PANEL	1	
9	64S02U01-40M002	LEFT DOOR HINGE	2	
10	00-40M004	GAS SPRING ASSEMBLY	1	
11	64S02U01-10M002	BOTTOM DOOR BASE HOLDER ASSEMBLY	2	
12	64S02U01-40M006	LEFT UPPER DOOR BASE HOLDER ASSEMBLY	1	
13	64S02U01-40M011	LEFT DOOR BASE ASSEMBLY	1	



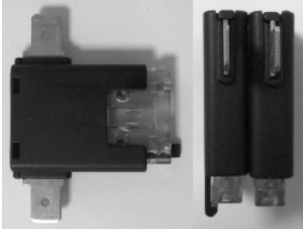





RIGHT TABLE

Position	Catalogue no.	Description	Qty	Price
1	64S02U01-50M004	RIGHT WINDOW ASSEMBLY	1	
2	64S02U01-50M012	RIGHT MIRROR ASSEMBLY	1	
3	00-00M019	POLYCARBONATE FIXING ASSEMBLY	21	
4	001703	DOOR HANDLE	1	
5	000841	OUTER DOOR LOCK	1	
6	001744	RIGHT INNER DOOR LOCK	1	
7	64S02U01-50M003	RIGHTT DOOR STOP ASSMEBLY	1	
8	64S02U01-50M008	RIGHT DOOR PANEL	1	
9	64S02U01-50M002	RIGHT DOOR HINGE	2	
10	00-40M004	GAS SPRING ASSEMBLY	1	
11	64S02U01-10M002	BOTTOM DOOR BASE HOLDER ASSEMBLY	2	
12	64S02U01-50M006	RIGHT UPPER DOOR BASE HOLDER ASSEMBLY	1	
13	64S02U01-50M011	RIGHT DOOR BASE ASSEMBLY	1	

ELECTROINSTALLATION

Position	Catalogue no.	Description	Qty
1	000968	SWITCH WIPER /WASHER /OFF	1
2	000885	WASHER TANK	1
3	001576	WASHER MOTOR	1
4	001652	FUSE BOX 2x1	1
5	002764	WIPER MOTOR 12V	1
6	64S01U01-01M005	RELAY HARNESS	1
7	64S02U01-01M004	WIPER HARNESS	1
8	002678	HEATER 12V	1
9	00-02W005	HEATER HOLDER WELDED	1
10	64S02U01-02M003	HEATER HARNESS	1
11	002386	EL. VALVE	1
12	002795	AIR HOSE PVC	1
13	000896	HEATER HOSE 16mm	1
14	002491	AIR VALVE	1
15	002391	EL. VALVE SWITCH	1
16	002702	HEATER SWITCH	1
17	002502	"Y" COUPLING 25-25-16	2
18	002705	ALUMINIUM TAPE	1
19	002643	TIGHTENING STRAP 21-38mm	4
20	001368	TIGHTENING STRAP 40-60 ZB	4
21	001367	TIGHTENING STRAP 12-22 ZB	10
22	002018	HOSE BUSHING	1
23	000881	WASHER HOSE EXTENSION	1
24	001571	BENDED HOSE	2
25	64S02U01-03M001	WASHER HARNESS	1
26	002626	HEATER HOSES PASS	1

		
<p>Position : 1</p>	<p>Position : 2</p>	<p>Position : 3</p>
<p>Catalogue no.: 000968</p>	<p>Catalogue no.: 000885</p>	<p>Catalogue no.: 001576</p>
		
<p>Position : 4</p>	<p>Position : 5</p>	<p>Position : 6</p>
<p>Catalogue no.: 001652</p>	<p>Catalogue no.: 002764</p>	<p>Catalogue no.: 64S01U01-01M005</p>
		
<p>Position : 7</p>	<p>Position : 8</p>	<p>Position : 9</p>
<p>Catalogue no.: 64S02U01-01M004</p>	<p>Catalogue no.: 002678</p>	<p>Catalogue no.: 00-02W005</p>

		
<p>Position : 10 Catalogue no.: 64S02U01-02M003</p>	<p>Position : 11 Catalogue no.: 002386</p>	<p>Position : 12 Catalogue no.: 002795</p>
		
<p>Position : 13 Catalogue no.: 000896</p>	<p>Position : 14 Catalogue no.: 002491</p>	<p>Position : 15 Catalogue no.: 002391</p>
		
<p>Position : 16 Catalogue no.: 002702</p>	<p>Position : 17 Catalogue no.: 002502</p>	<p>Position : 18 Catalogue no.: 002705</p>

		
Position : 19	Position : 20	Position : 21
Catalogue no.: 002643	Catalogue no.: 001368	Catalogue no.: 001367
		
Position : 22	Position : 23	Position : 24
Catalogue no.: 002018	Catalogue no.: 000881	Catalogue no.: 001571
		
Position : 25	Position : 26	
Catalogue no.: 64S02U01-03M001	Catalogue no.: 002626	