



INSTALLATION INSTRUCTIONS

POLARIS

RNG 1000 XP EPS (2018)

SAFETY INSTRUCTIONS

Warning: Failure to heed all safety and operating instructions and warnings regarding use of this product can result in serious bodily injury.

READ COMPLETE ASSEMBLY INSTRUCTIONS BEFORE STARTING OF ASSEMBLY

Install all parts indicated in assembly instructions. Failure to fully assemble product before use could result in personal injury.

Assembly of product requires use of hand or power tools. If you are not experienced in using these types of tools, have product dealer do the install for you.

Some parts contain sharp edges, wear protective gloves if necessary. Always keep your assembly area clean, uncluttered and well lit.

Keep visitors and children a safe distance away from the assembly area. Visitors should wear the same safety equipment as installer.

Never operate your UTV with the cab doors open. Failure to properly latch the doors before moving the vehicle could result in serious injury.

Dress for safety. DO NOT wear loose clothing, gloves, neckties or jewelry if using power tools to assemble this product. Insert all nut covers after you finish installation.

Never drive your UTV with the cab front window in open position.

Failure to properly latch/lock front window before driving the vehicle could result in serious injury.

MAINTENANCE AND CLEANING

To clean polycarbonate surface use soapy water solution or other subtle means.

Wash off dirt and dust by using gentle water stream and swipe only with wet or damp means in the direction from top to bottom.

The recommended frequency of cleaning of polycarbonate part is about 1 time per month or according to the actual degree of pollution.

Do not use detergents that could scratch the surface plates. (abrasives, harsh fabrics, etc.)

Do not use solvents or alkaline detergents or cleaners with ammonia (ammonium hydroxide).

Do not remove the impurities from the surface of the razor blades or other sharp items.

Do not clean cab when the polycarbonate plates are heated by the sun.

Do not use a squeegee as it could scratch the surface plates.

Do not clean with a water strength greater than 50 bar (WAP)

The manufacturer is not responsible for scratches on the surface due to failure to comply with the above instructions.

All bolted connections of cab must be checked and tightened by user at regular intervals.

ELECTROINSTALLATION
HEATER

Connect the pulse bar with the original ground screw.

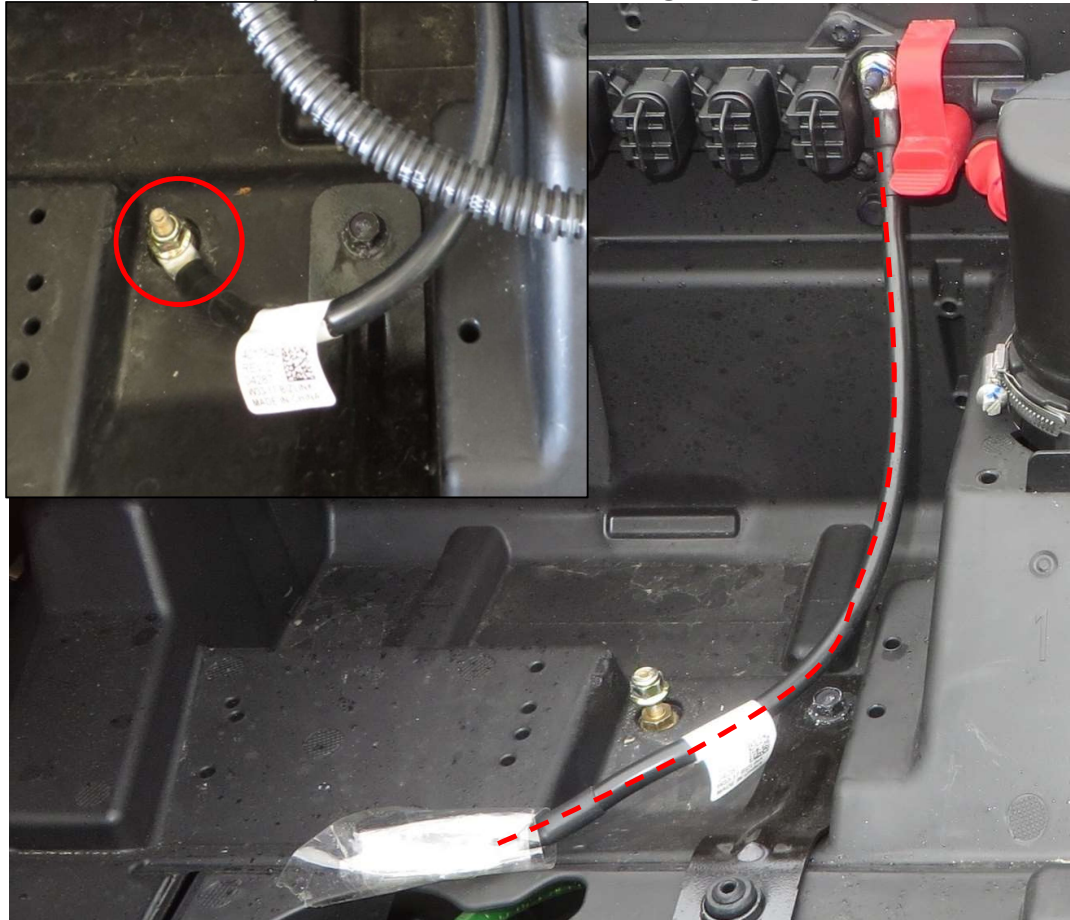

Remove the original cable grommet from the dashboard hole. Cut the hole in the grommet for the wiper, washer and heater harness.



Remove all dashboard fixing plastic cover push pin rivets.

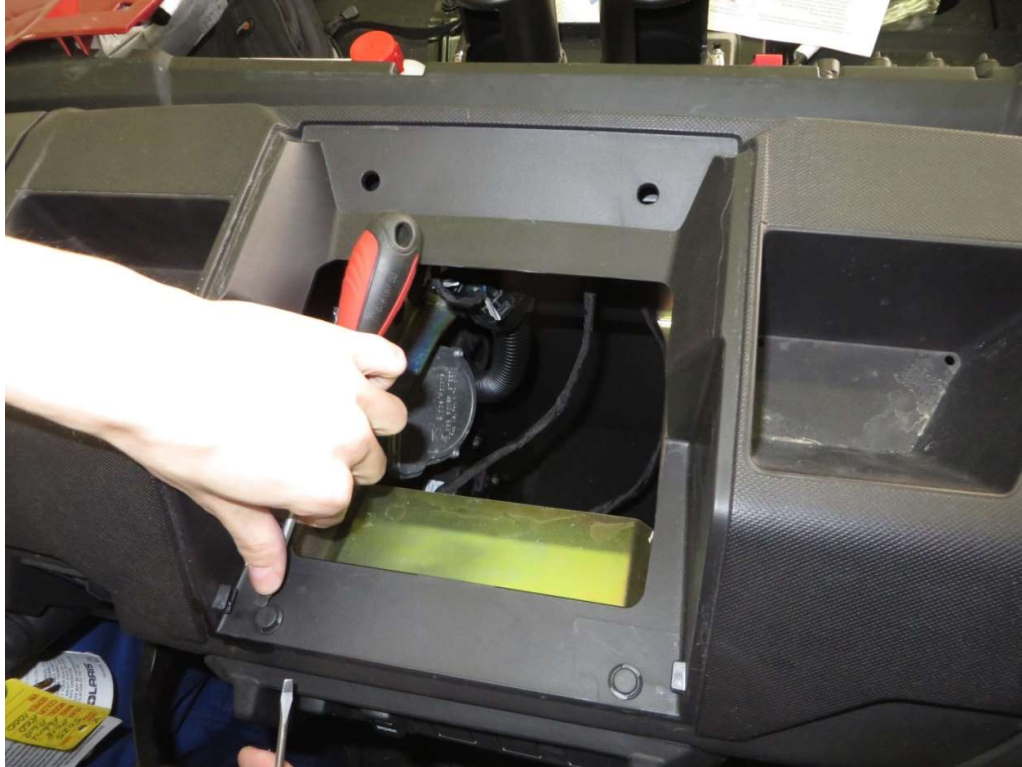

Tilt steering wheel to full down position. Detach instrument cluster hood by removing two push pin rivets, then slide hood (and instrument cluster) rearward. Disconnect instrument cluster wiring harness.



5

Remove the plastic dashboard cover.



Remove lower storage compartment by removing six push pin rivets.



6

Remove four push pin rivets from each side of center floor console, and two push pin rivets from interior of underseat storage compartment. Lift back of console, disengage tab from front, then remove console from vehicle. Retain rivets.

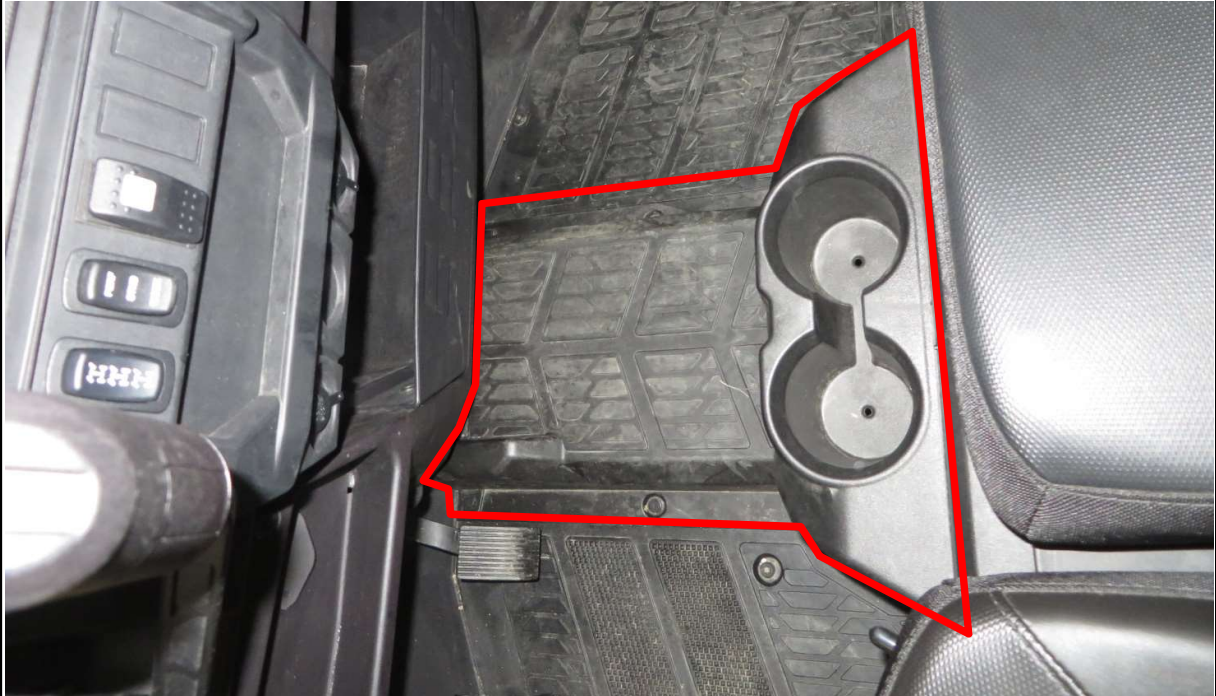

7

Route the longest pre-cut heater water hose from the engine space to right front wheel.

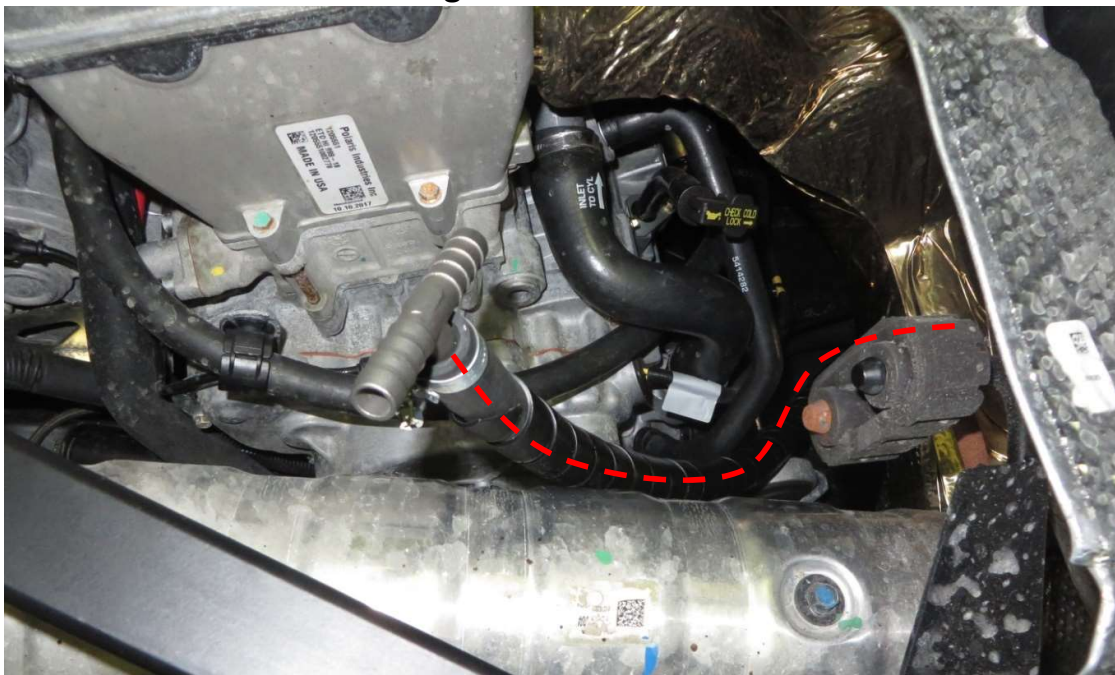

Route the longest pre-cut heater water hose through the central tunnel.



Position of the end of the heater water hose.

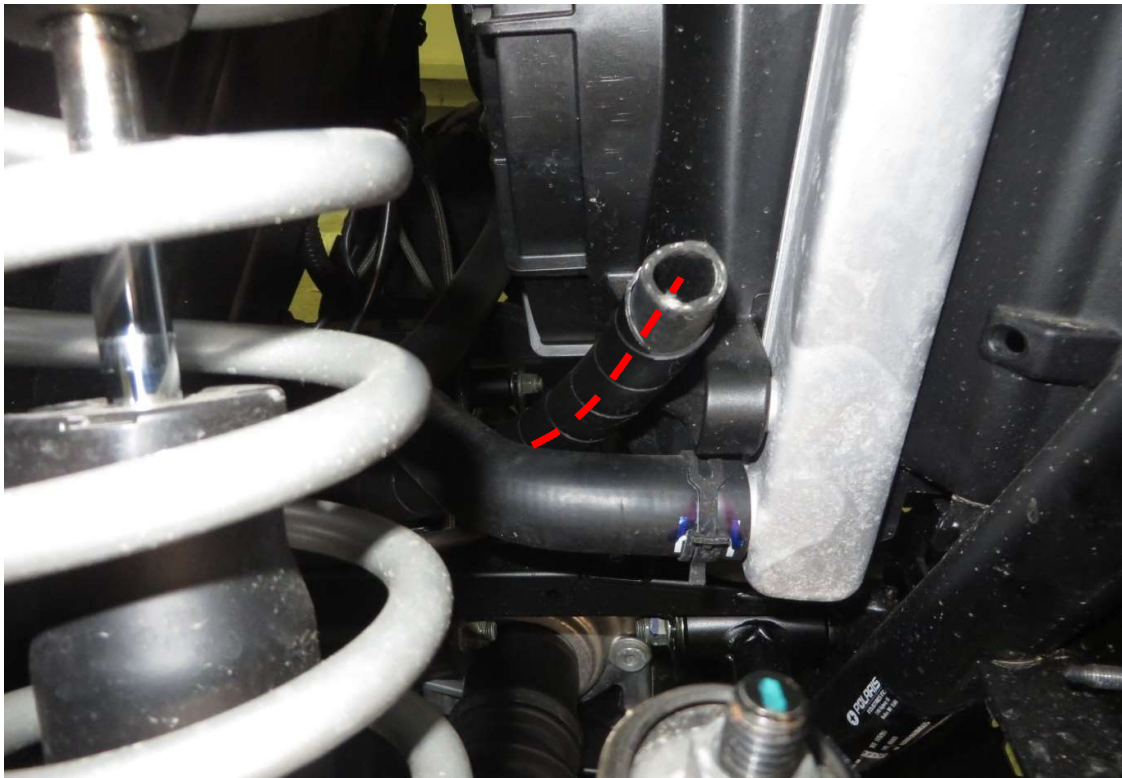

8

Remove two push pin rivets from lower face of control panel. Retain rivets.

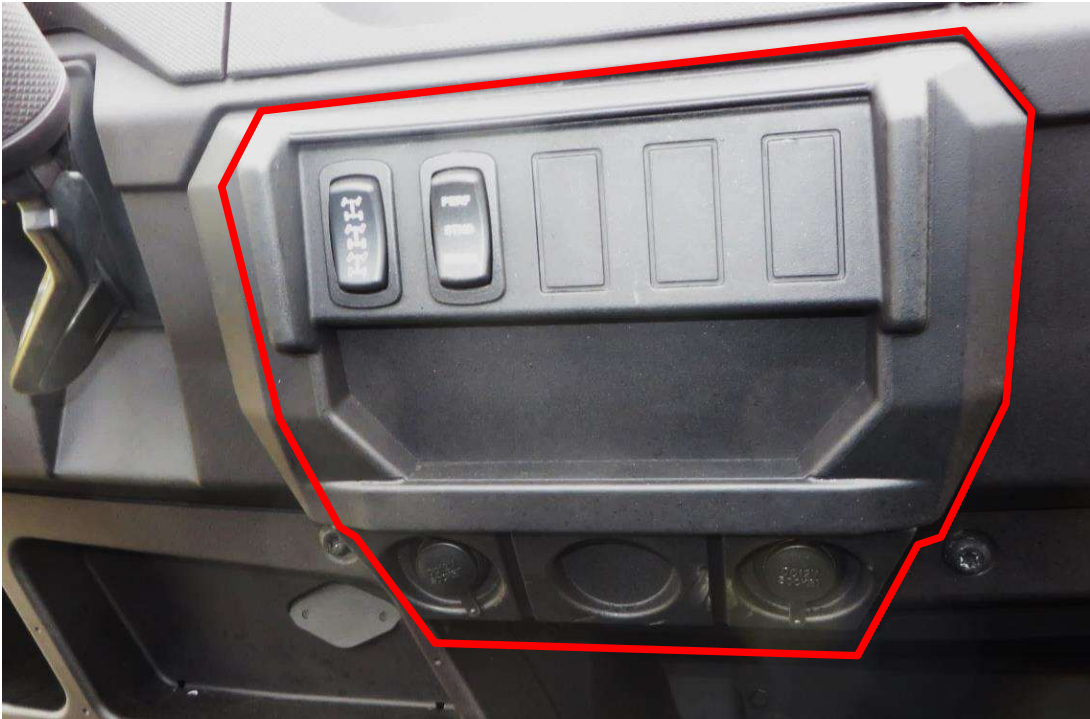

Carefully cut out marked rectangular area from control panel. Install the plastic switch size reduction into the prepared hole.



9

Install the wiper/washer switch into the plastic reduction.



Connect the wiper/washer switch harness with the wiper/washer switch.

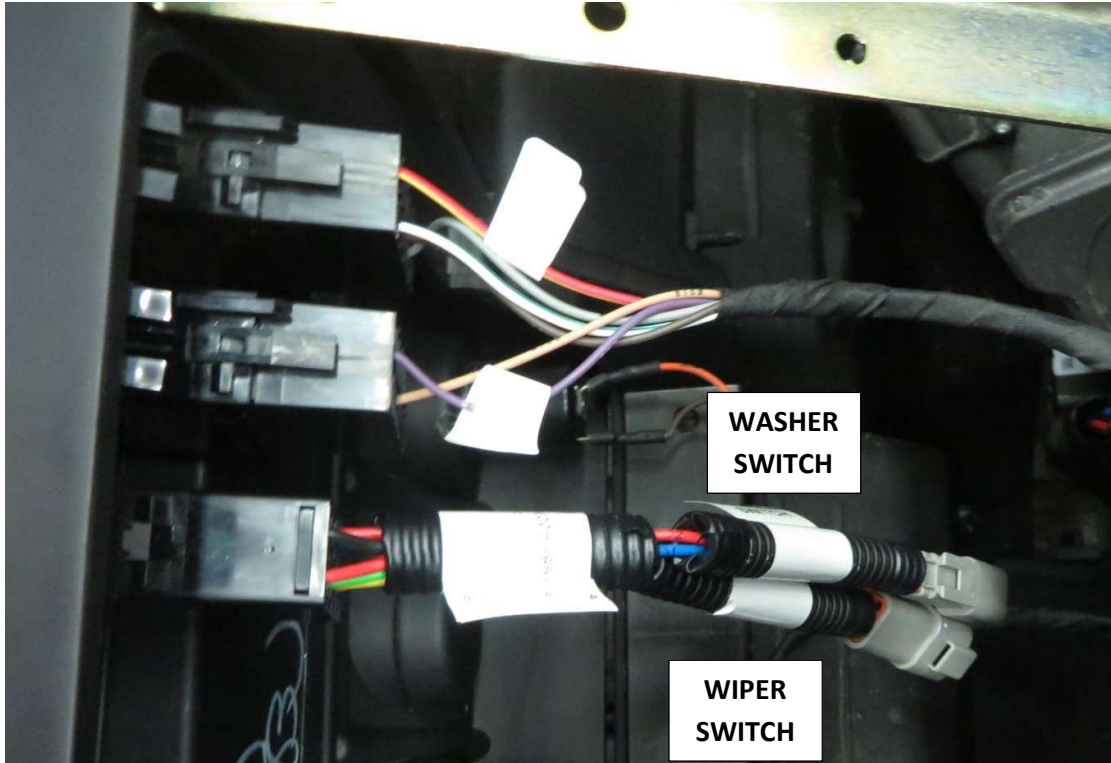

10

Remove two fixing screws, then remove dashboard support bracket.



Remove two fixing screws, then remove dashboard support ledge.

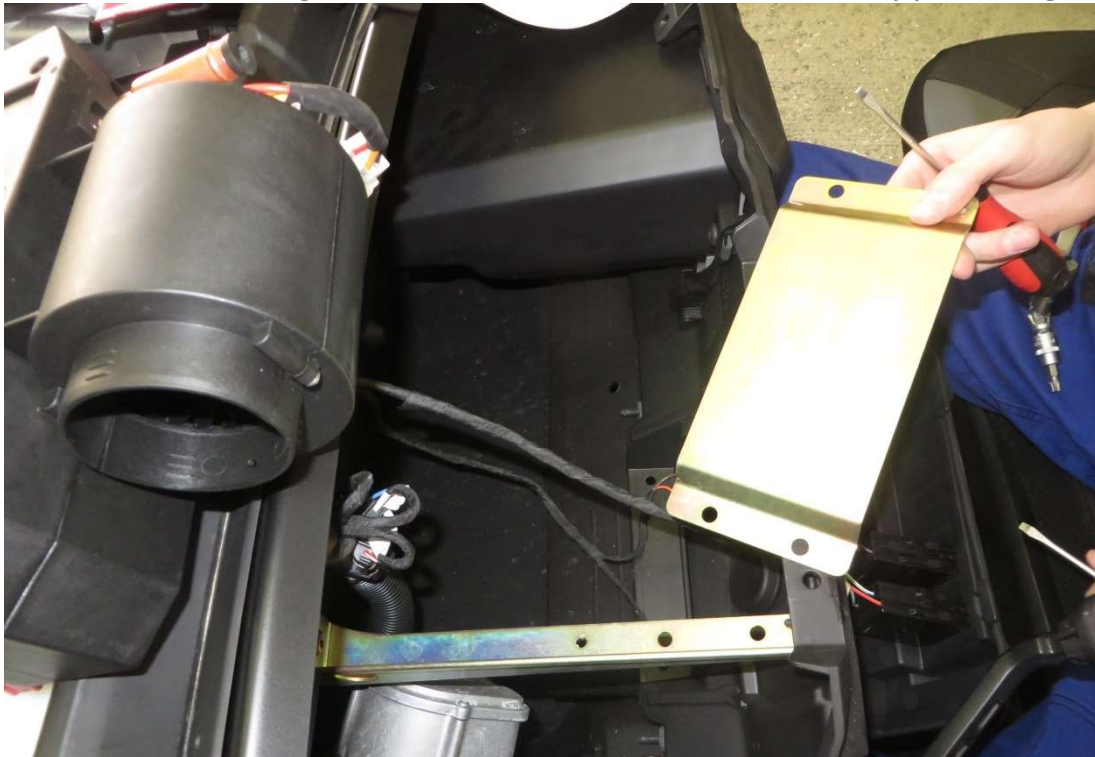

Place the heater to the space under the dashboard.



Make marks of the heater hoses position and fixing screws position. Take the heater out and drill two holes \varnothing 20 mm for heater core hose fittings.

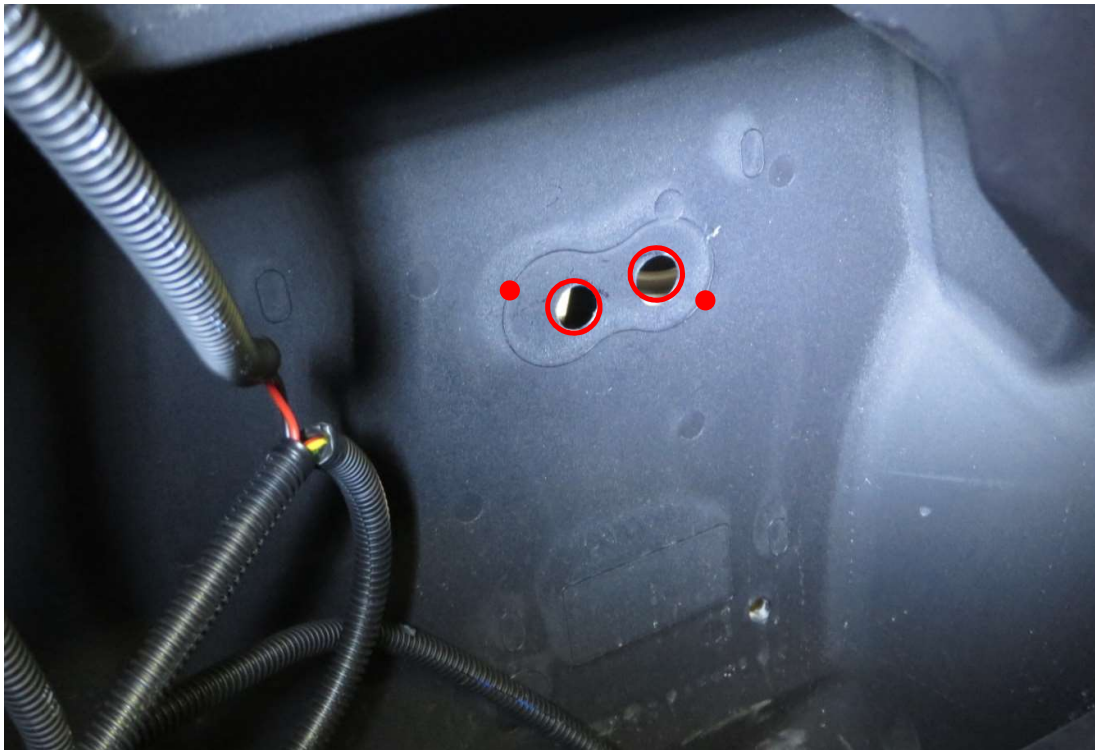

12

Drill two holes \varnothing 55 mm for the heater air vents.



Second heater air vent position.



Connect the heater harness branch with the heater connector.



Connect the water pump harness with the electromagnetic valve.

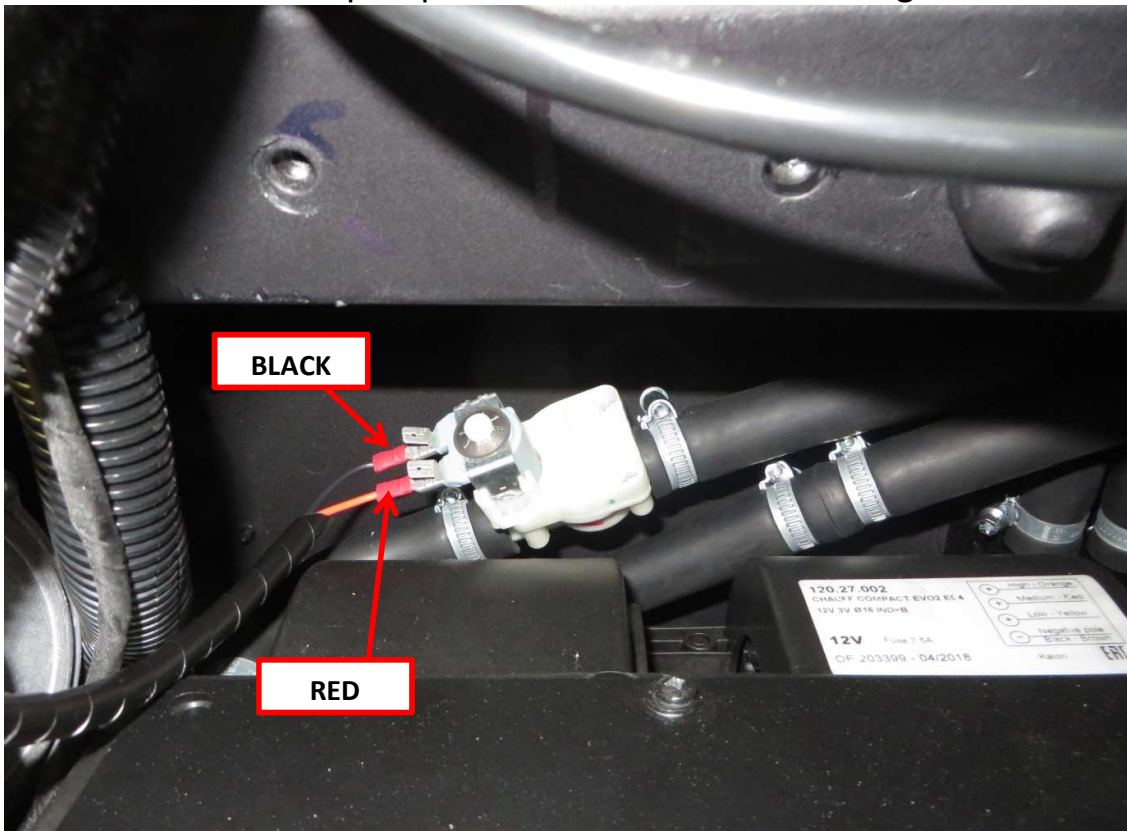

Connect the electric valve harness branch with the electromagnetic valve.

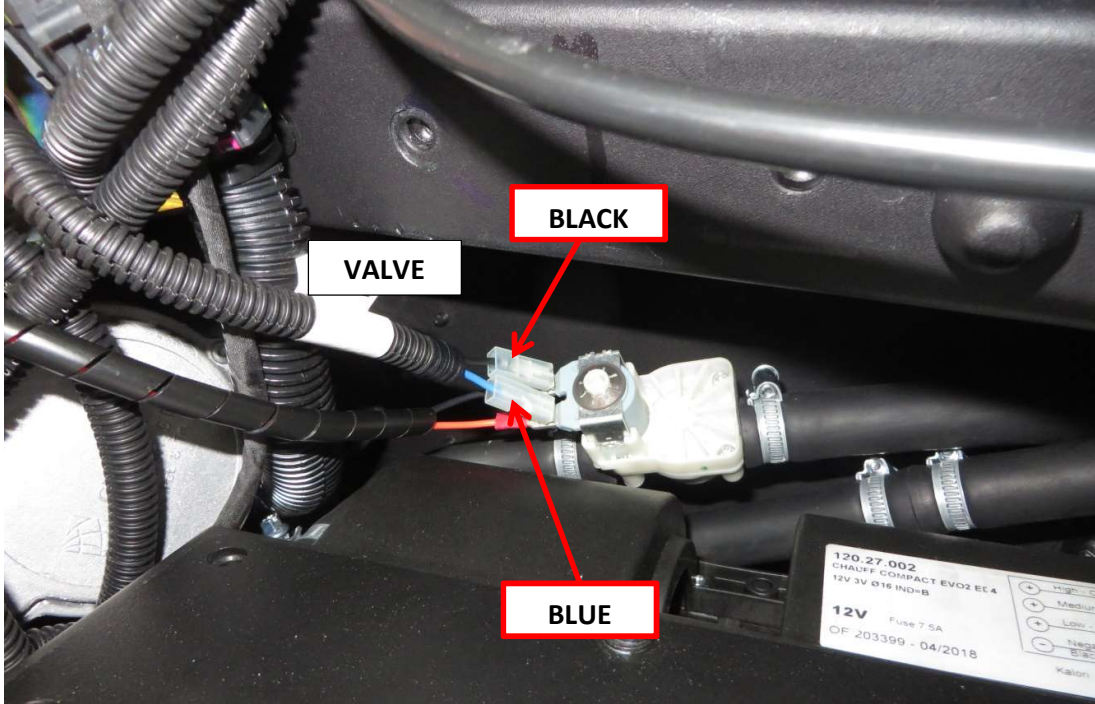

Attach the heater holder with included fixing assemblies.

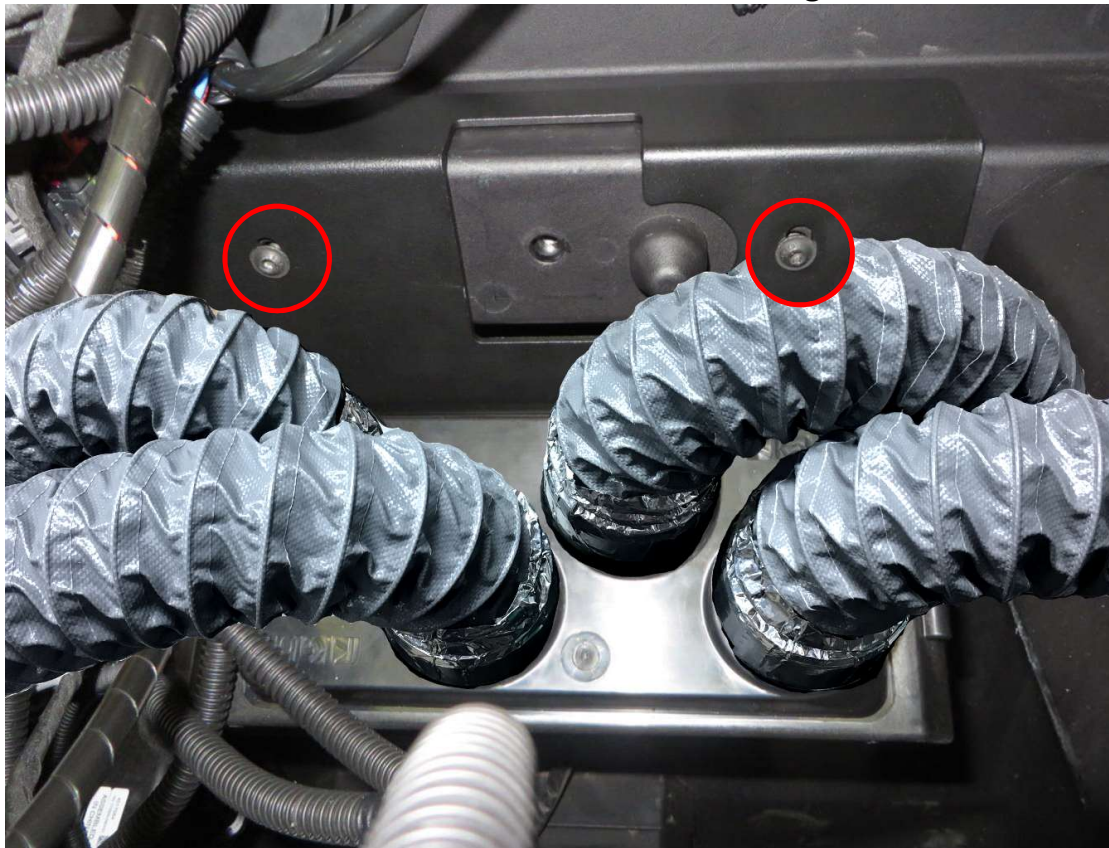

Install the heater fitting into the prepared holes.



Attach the heater fitting with two included self-cutting screws from the right front wheel space.



16

The side heater air hoses (red lines) route to the bottom air vents and the heater air hoses from the center of heater (green line) use for upper air vents.

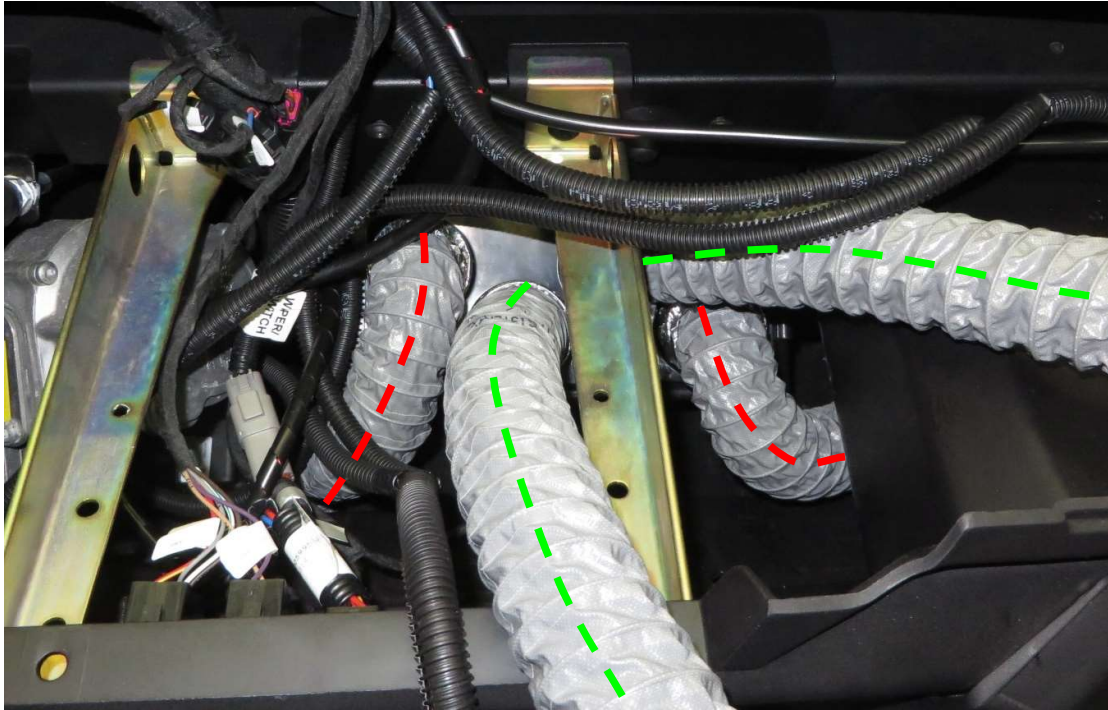

Prepare the heater hose with bleeding valve and "Y" coupling.



Secure the original cooling system hose with clamp. Cut the hose between clamps. Cut a 2 cm long piece of hose.

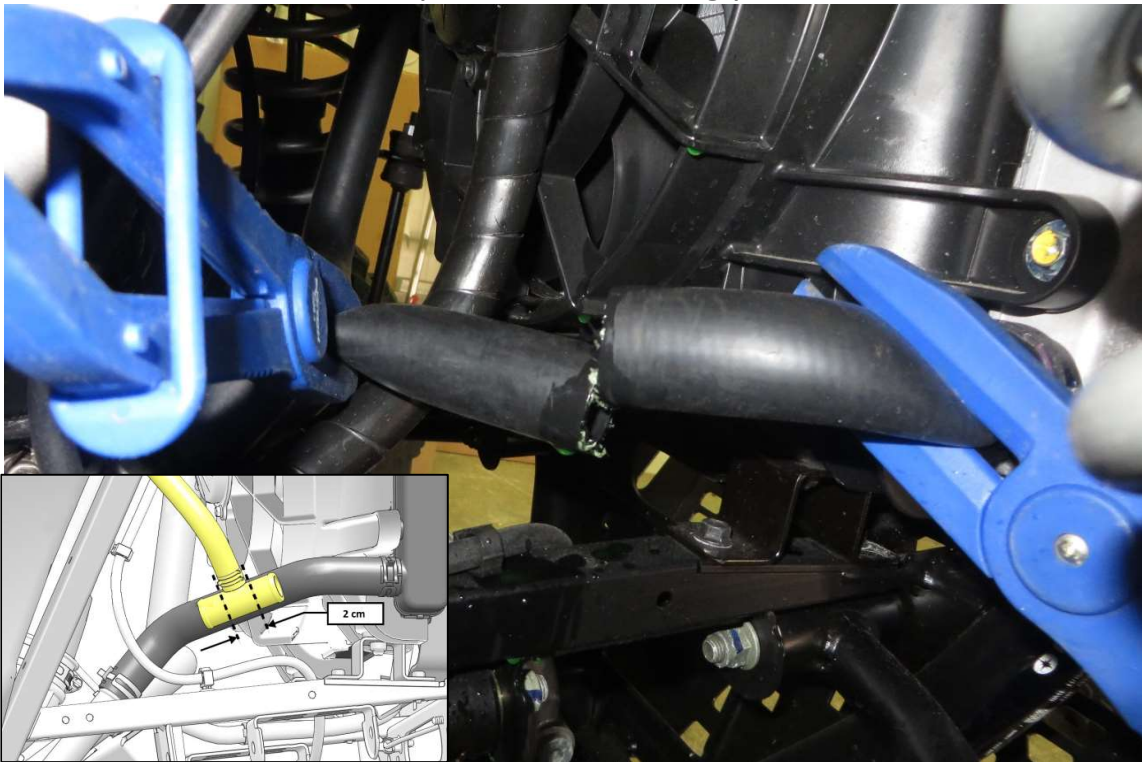

Install the “Y” coupling onto the both end of the cutted hose. Attach the both end of hose with tightening straps

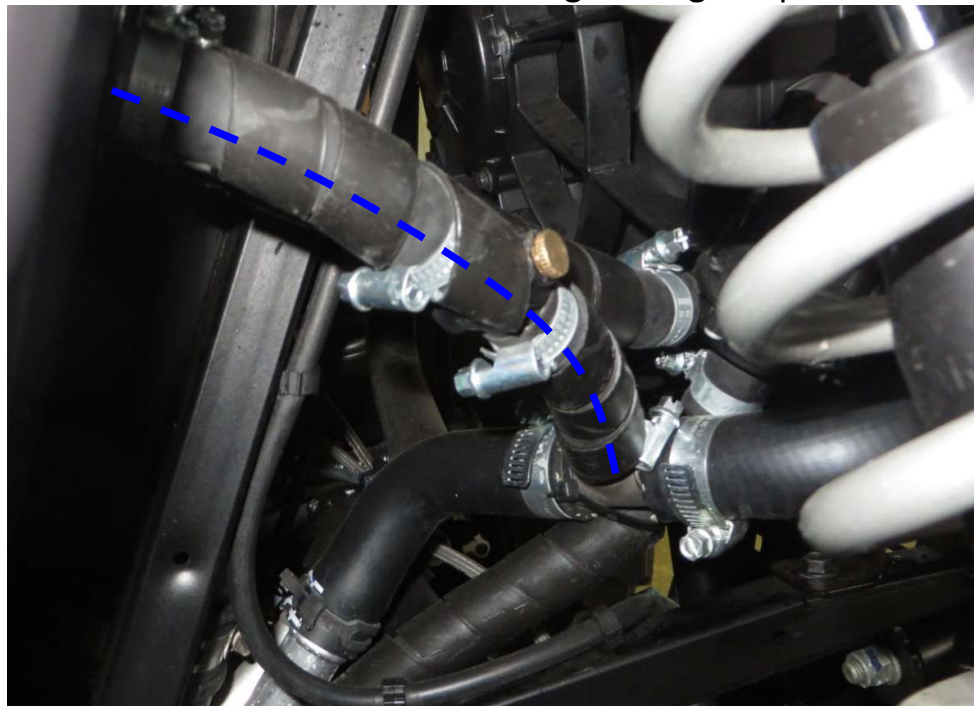

Attach heater water hose onto the heater fitting with included tightening strap. This heater water hose must be installed on a non-electromagnetic valve heating hose (output from the heater).



Install the water pump onto the heater hose routed from the engine space. Attach the hose with included tightening strap.

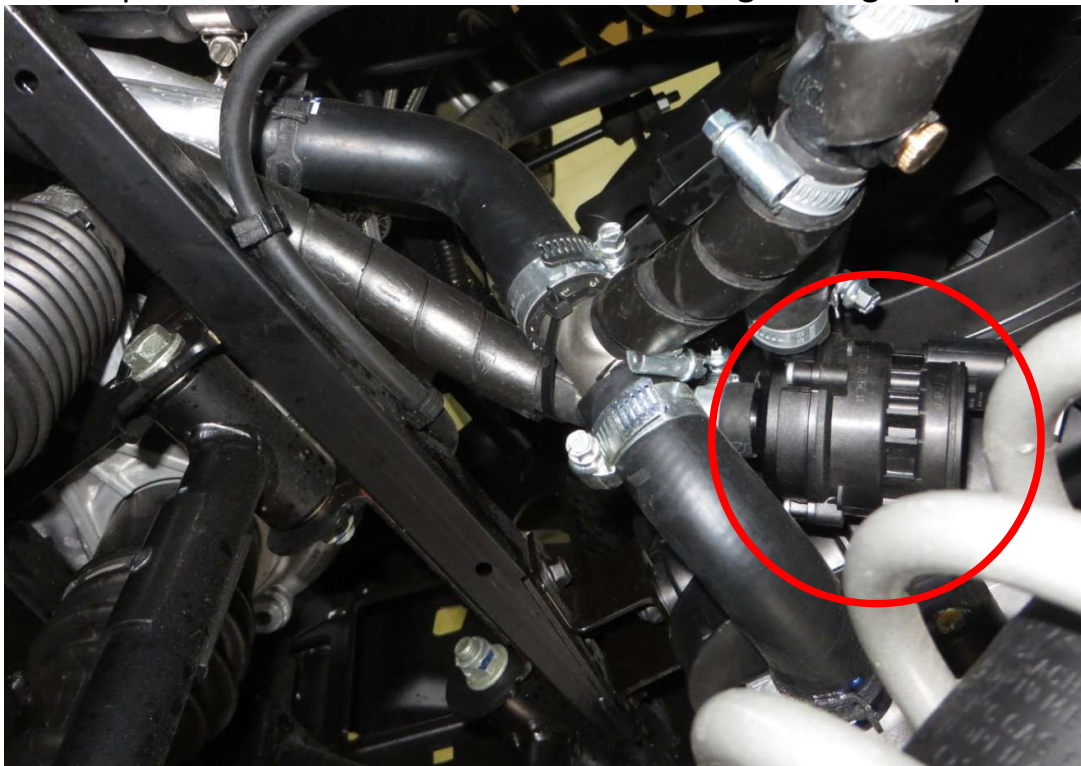

Attach heater water hose from the water pump onto the heater fitting with included tightening strap. This hose must be installed on the heating hose with electromagnetic valve (input to the heater).

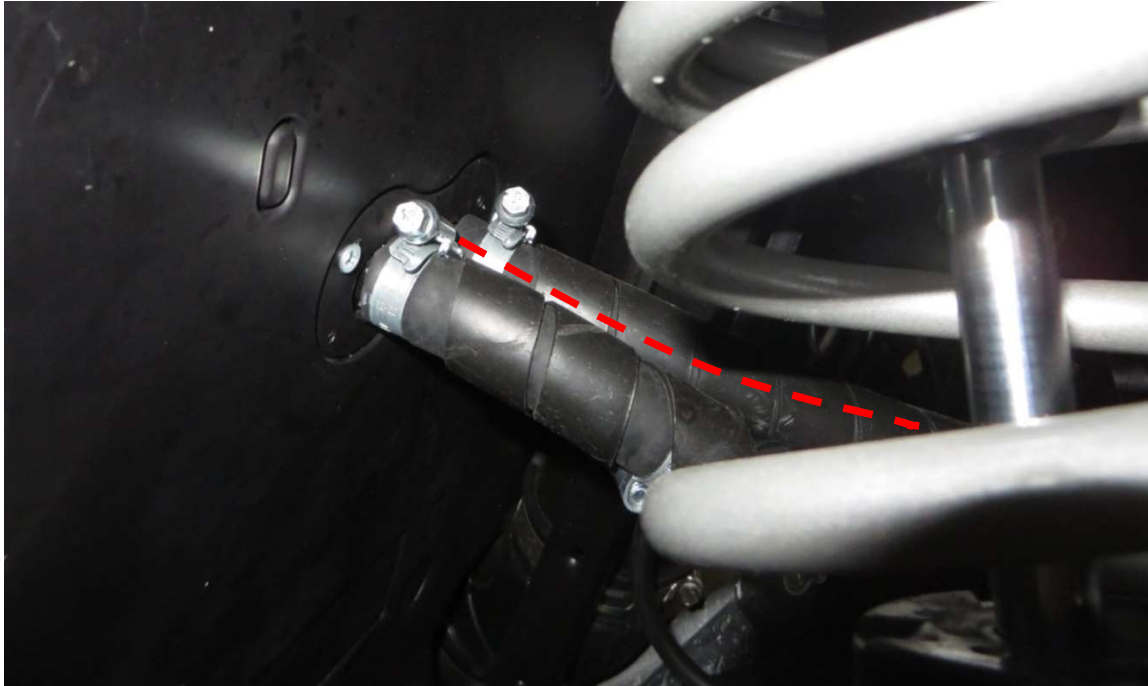

Secure the original cooling system hose with clamp. Cut the hose between clamps.



Install the “Y” coupling onto the both end of the cutted hose. Attach the both end of hose with tightening straps

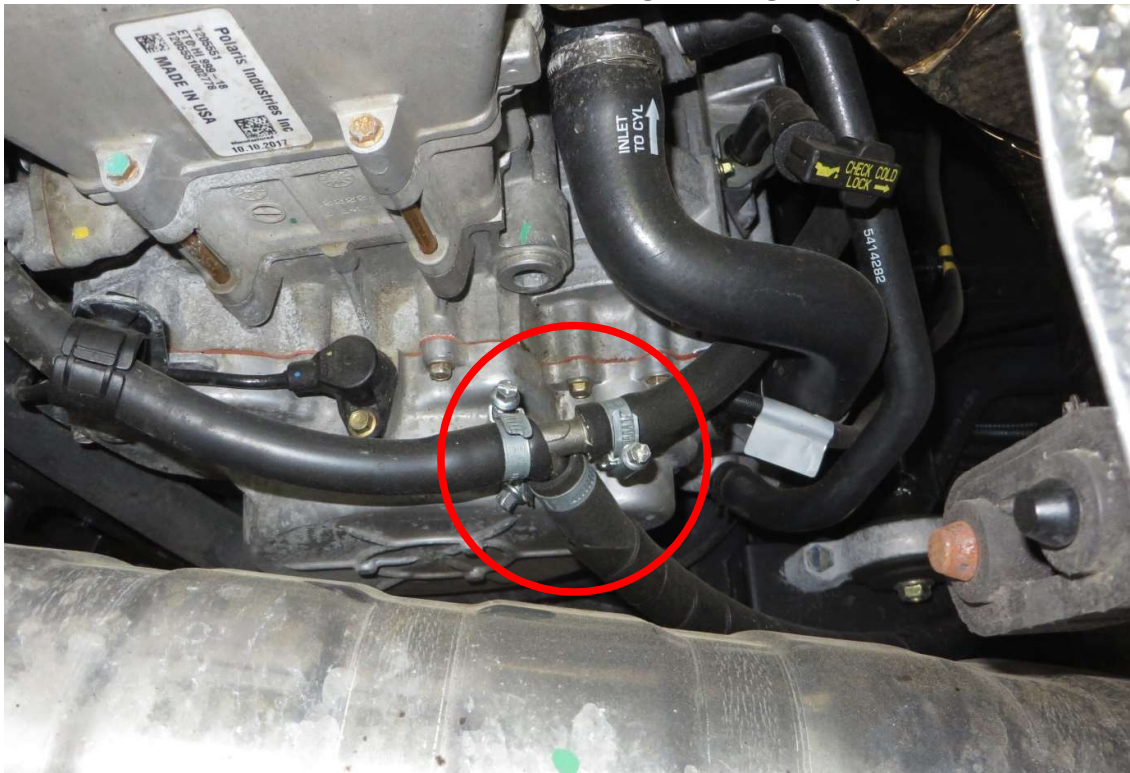

21

Install the dashboard support bracket and the dashboard support ledge back to original position with original fixing assemblies.

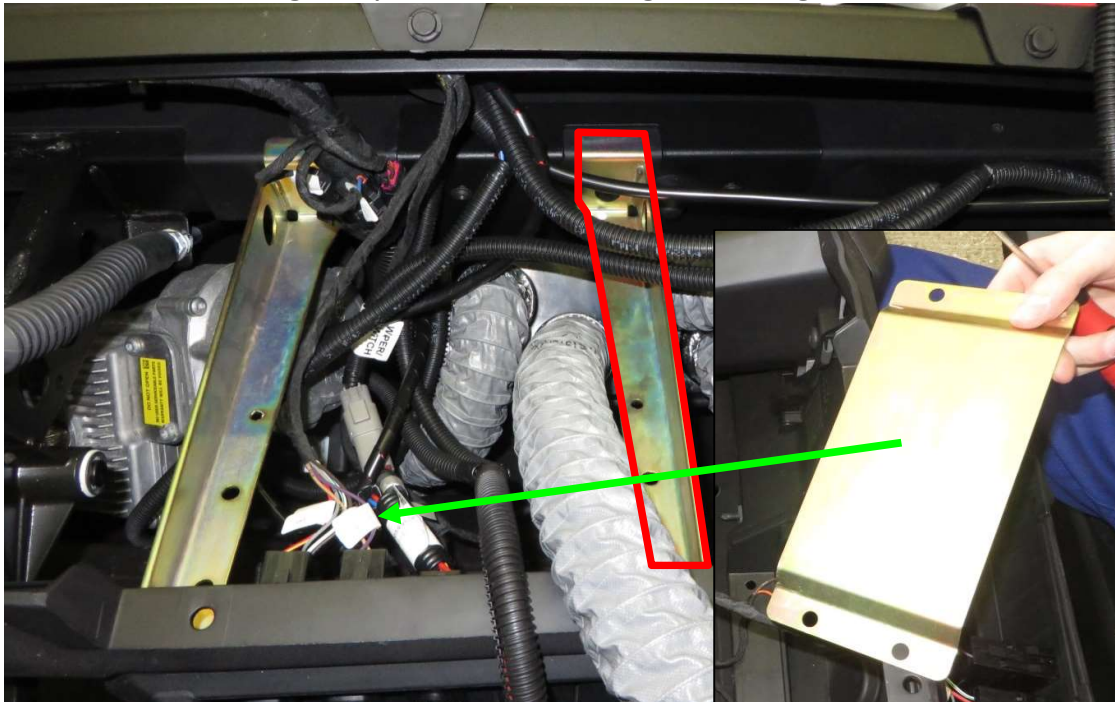

Route the water pump harness from the electromagnetic valve inside the under hood space.



Route the water pump harness through the original hole to the right front wheel space.



22

Attach the water pump harness onto the UTV frame with plastic cable ties

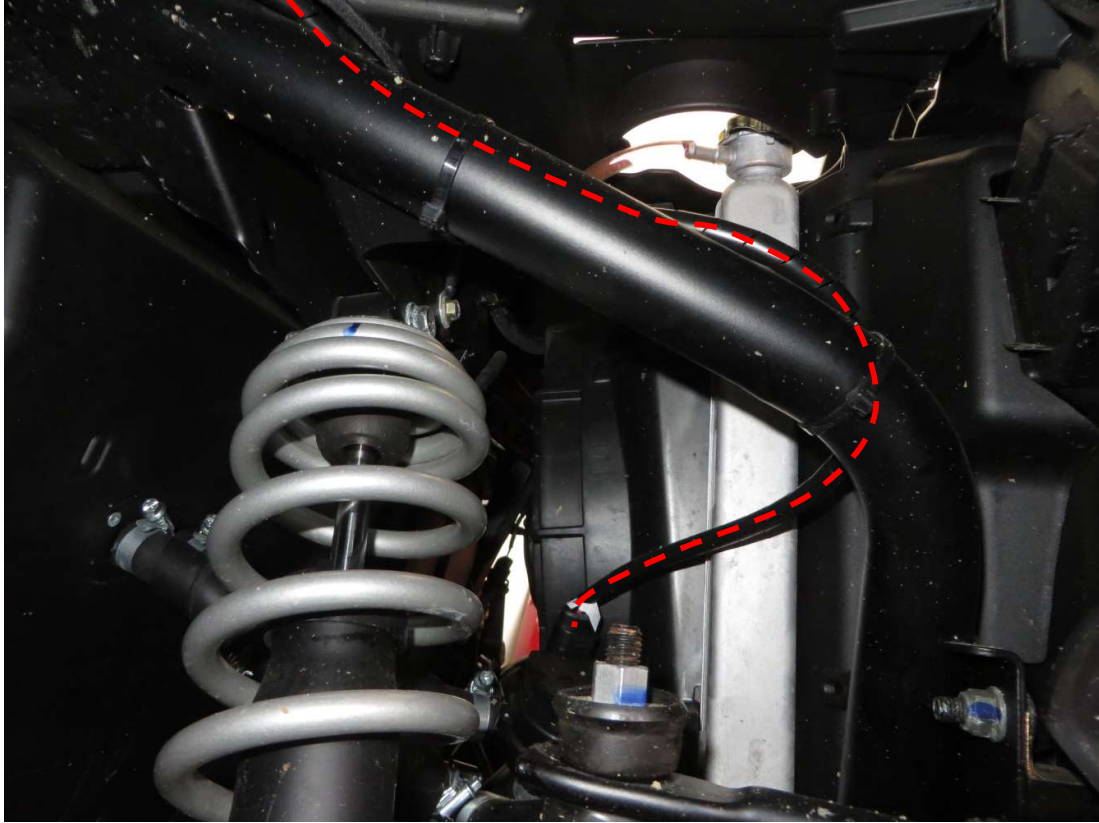

Connect the water pump harness with the water pump.

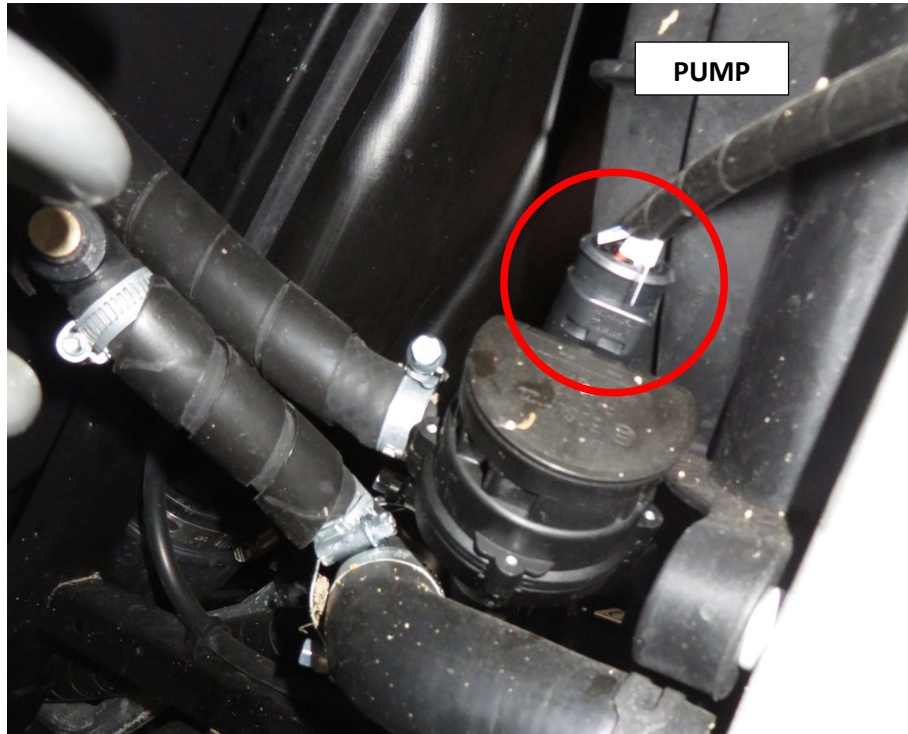

WASHER

Mount the washer tank bracket onto the washer tank holder with included fixing assemblies.

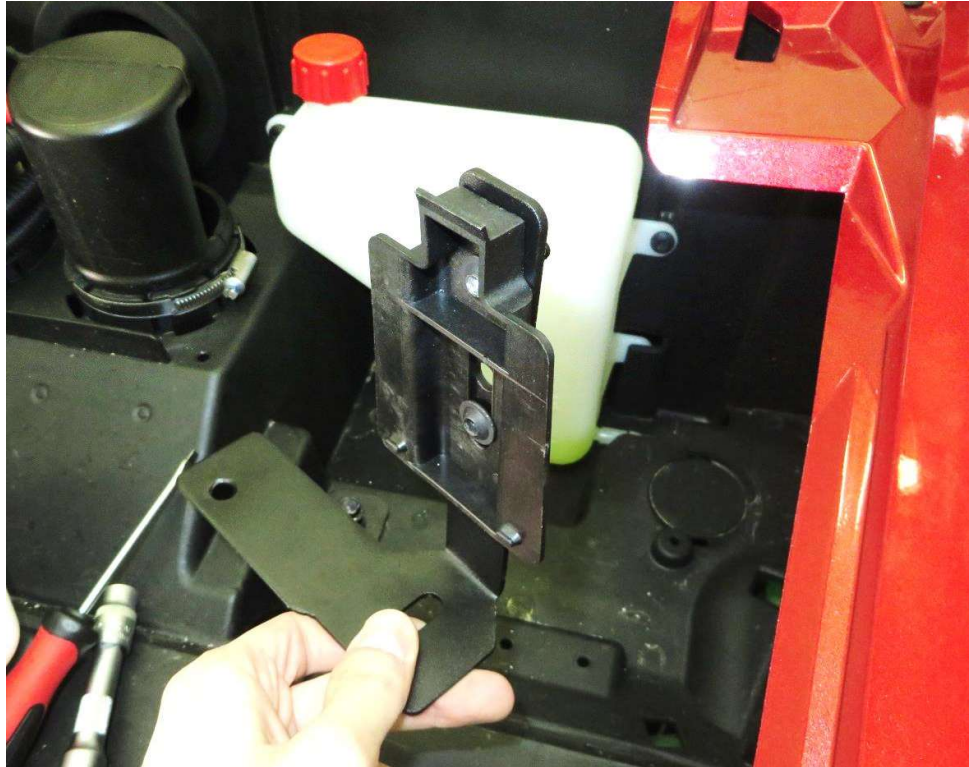

Connect the washer motor harness branch with the washer motor.
Connect the washer tube with washer motor.



Attach the washer tank holder with original screws.



Route the washer tube to the right roll cage tube.



25

Remove the hood and find the pulse bar in under hood space.

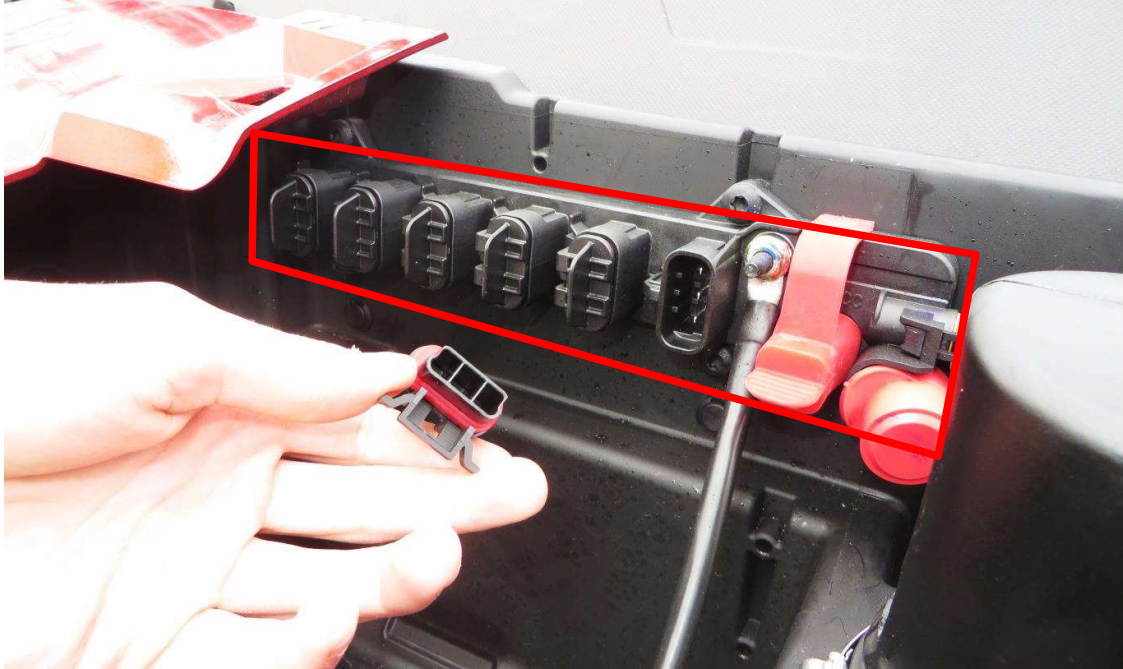

Remove the connectors covers and plug washer harness into the connector.

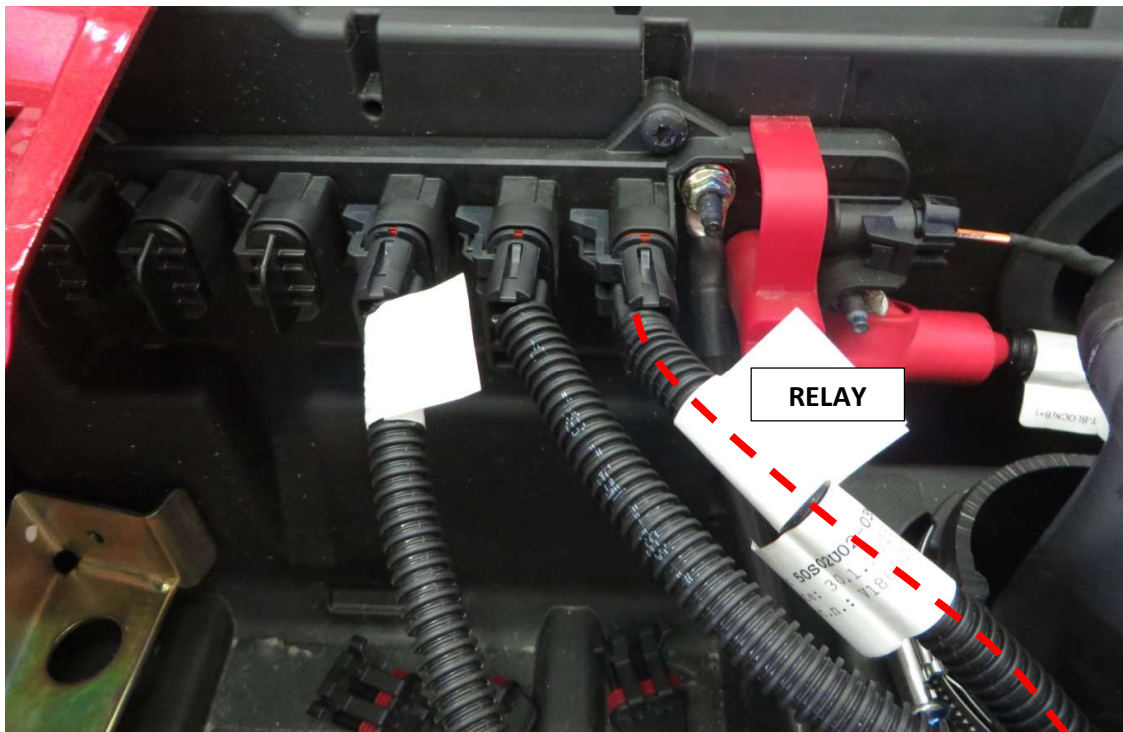

Connect the wiper and washer harness branches with the wiper/washer switch harness.

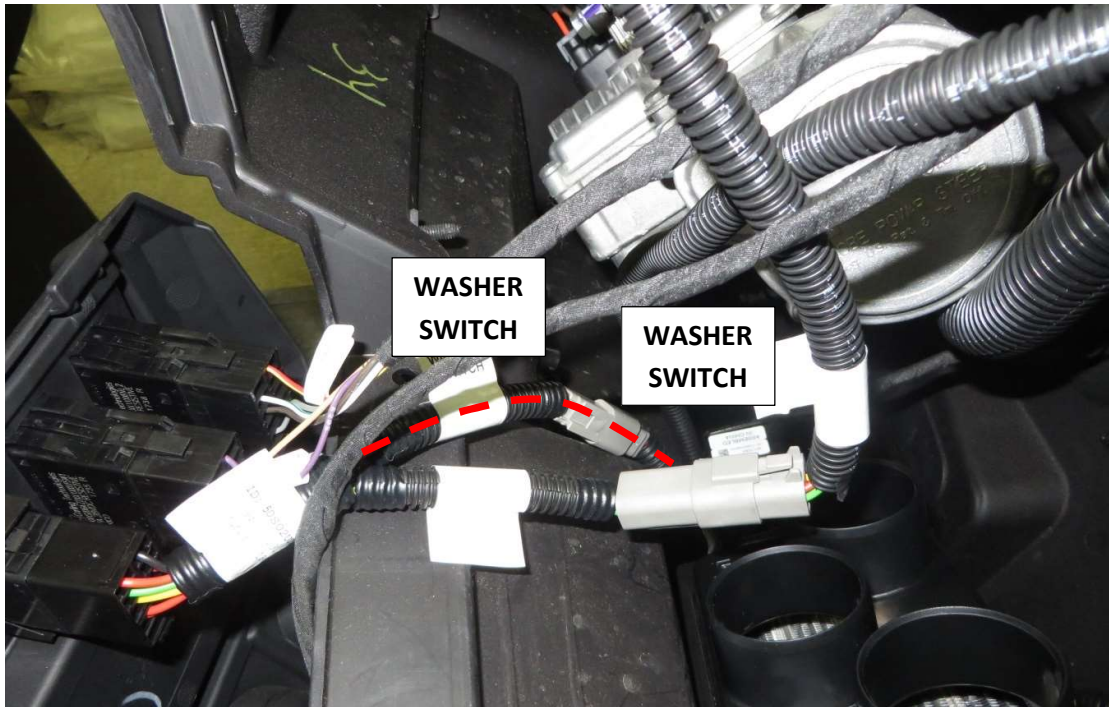

Mount the face of control panel back to the original position.



Mount lower storage compartment with original six push pin rivets. Be careful about the heating hoses and harness during assembly.



28

Mount the center floor console with original push pin rivets.

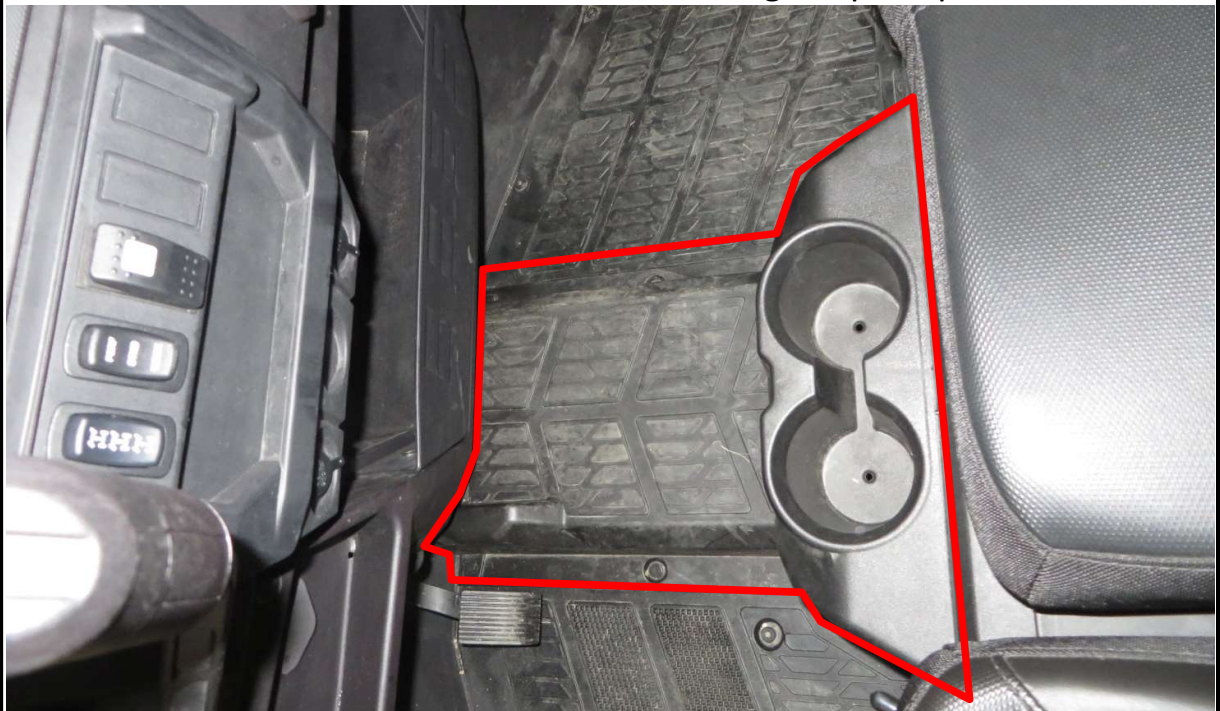

Route the wiper, washer and heater harness through the original rubber grommet.



Install rubber grommet for the harnesses to the original position.



Plug the heater harness into the pulse bar connector.



Install the dashboard back to the original position. Attach the dashboard with original push pin rivets. The heater air hoses and the heater harness route through the dashboard hole.



30

Drill two holes \varnothing 50 mm to the upper dashboard cupholder for heater air hoses.



Mark the position of the heater air vent cover holes onto the upper dashboard cupholder.



31

Drill three holes on marked positions for the heater ventilator switch.
Center hole \varnothing 12 mm and side holes \varnothing 3 mm.



Install the ventilator switch and the air vent cover onto the upper dashboard cupholder.



32

Connect the electric valve switch with the valve switch heater harness branch.



Scheme of connection.

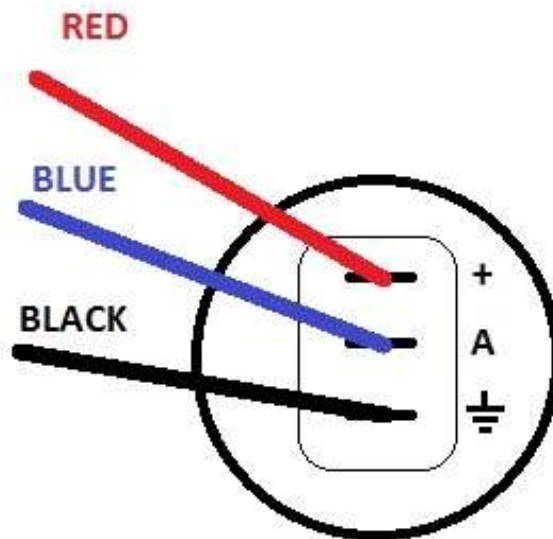

Connect the heater ventilator switch with the heater harness ventilator branch.



Route the heater air hoses through the prepared holes. On the ends of the hoses install the air vents. Attach air vents with tightening straps.



34

WIPER

Plug wiper harness into the pulse bar connector.

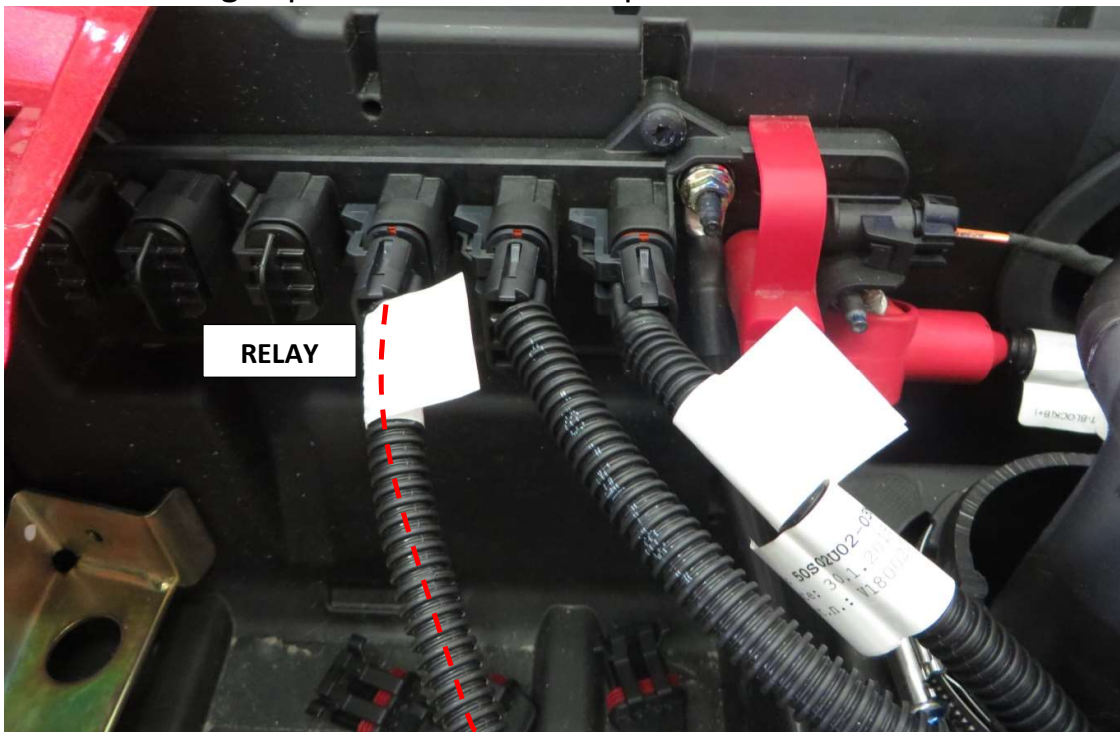

Connect the switch harness with the wiper harness.

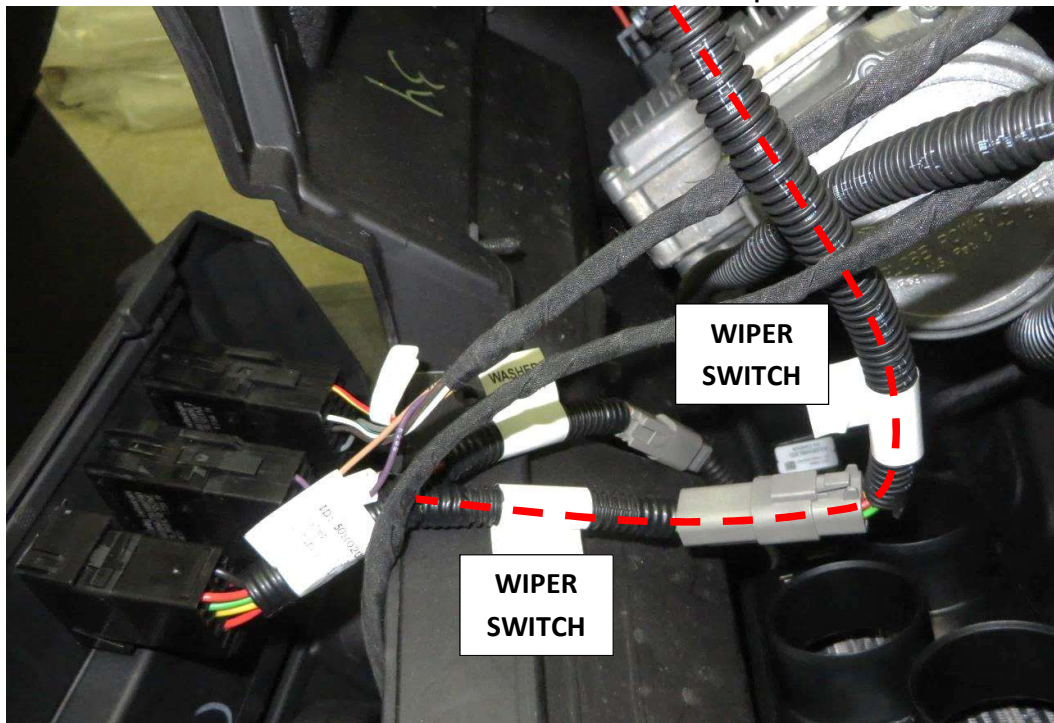

35

Route the wiper harness next to the UTV roll cage tube.



Route the wiper harness onto the UTV roll cage tube.



Route the wiper harness and the washer tube to the wiper motor.

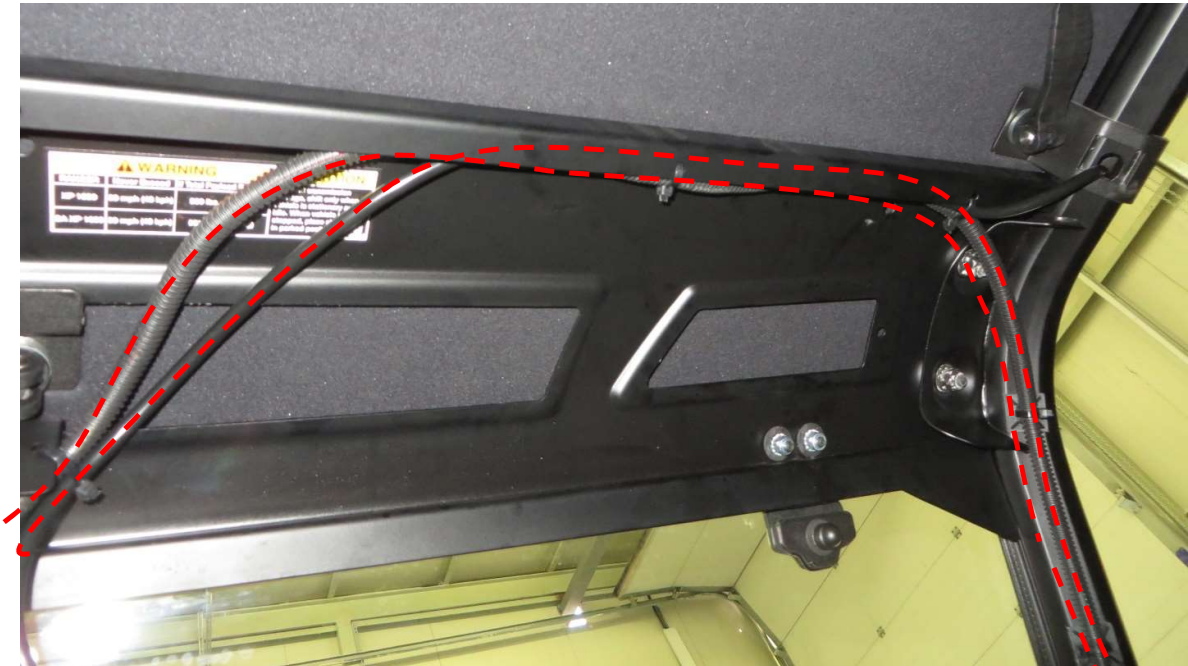

Connect the wiper harness with the wiper motor. The washer tube route through the plastic grommet inside the glass hole.



Connect the washer tube with the washer jet.



PREPARATION FOR INSTALLATION:

Uninstall all additional systems from the roller cages (work lights, rear mirrors, drink holders etc.)

CAB PREVIEW



39

FRONT PANEL

Loosen the original plastic rivets and remove the drink holder from the dashboard.

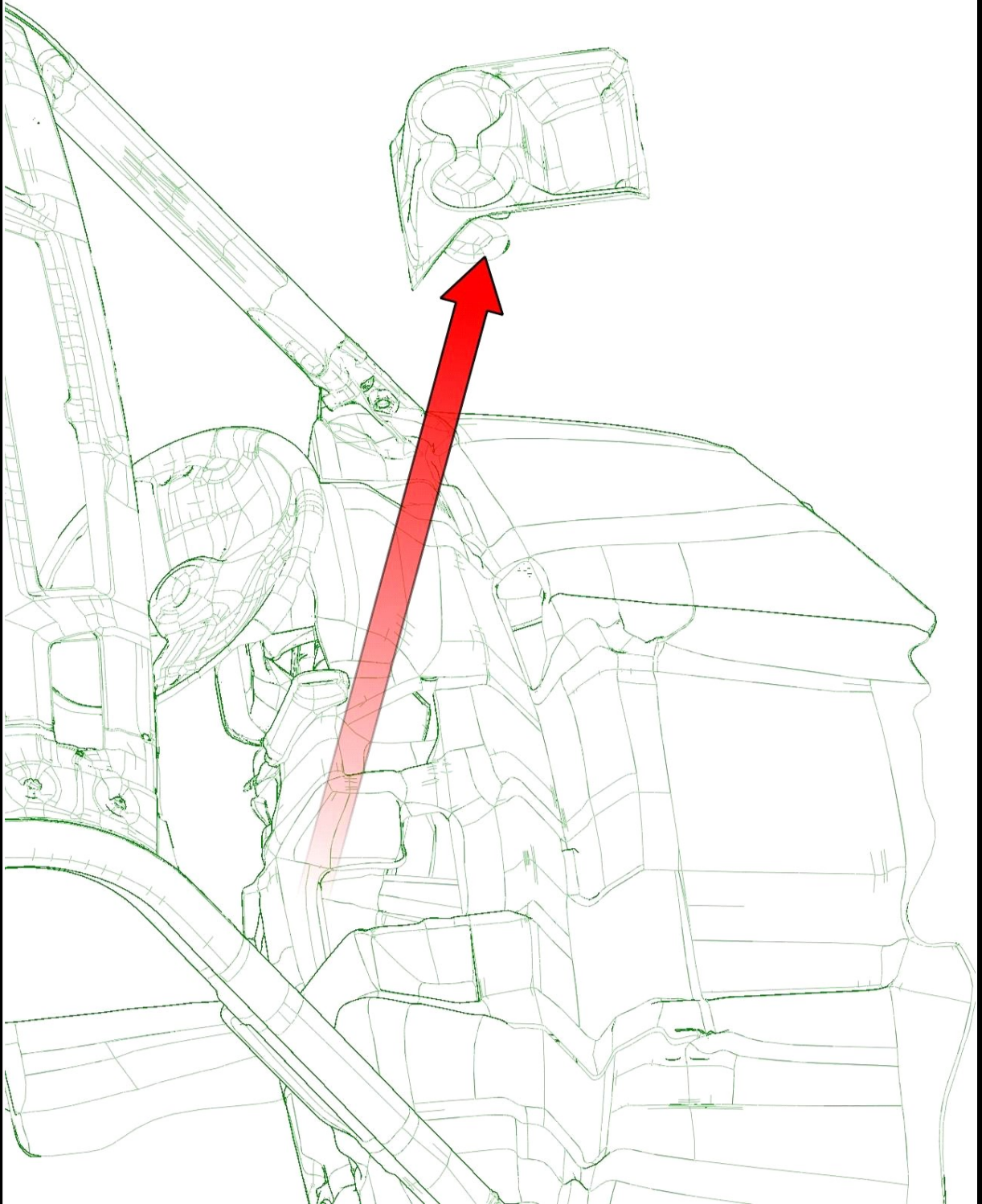

40

Attach the front glass stop holder onto the disassembled drink holder with included fixing assemblies.

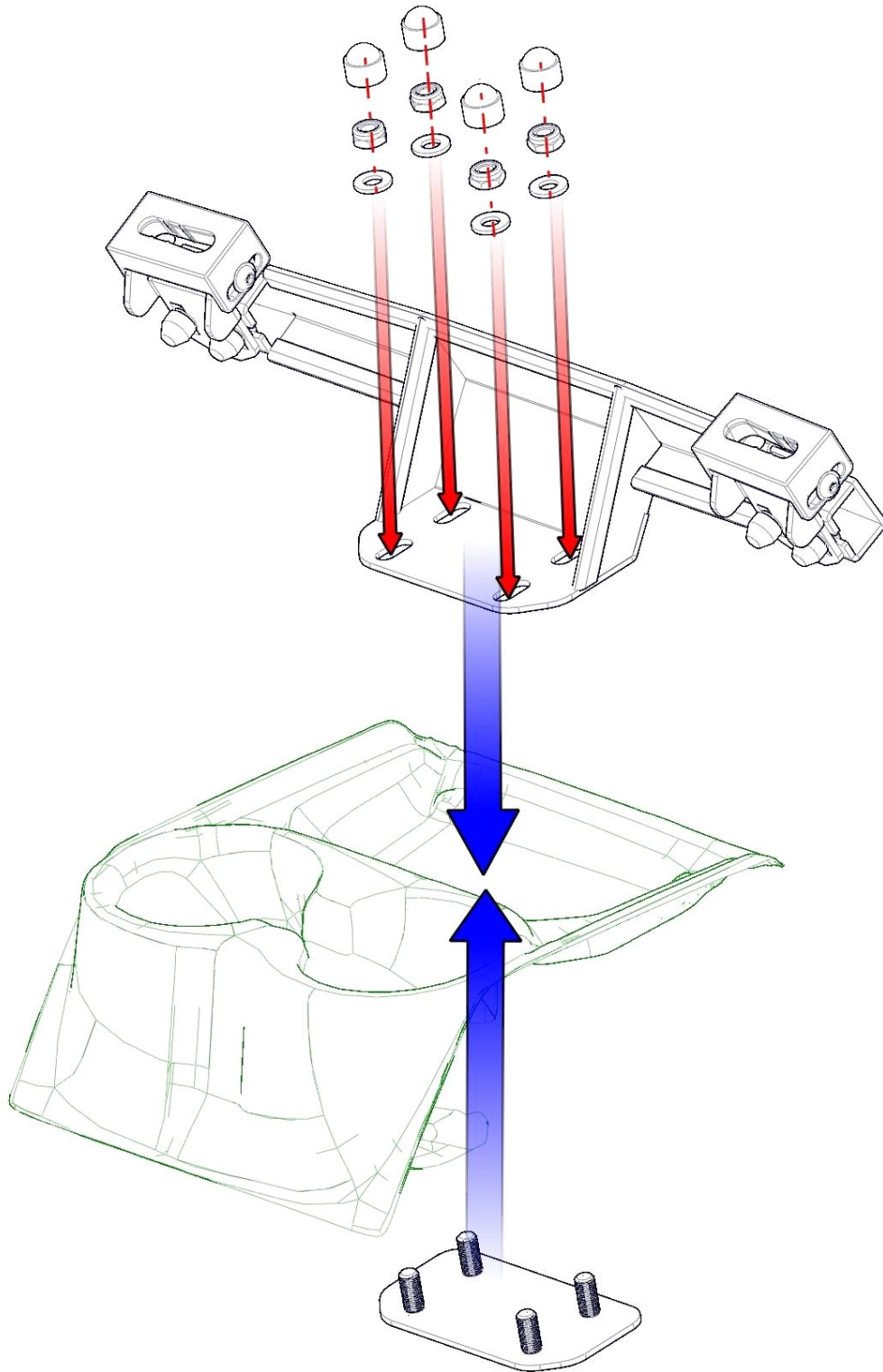

Mount the drink holder with installed front glass stop holder back to the original position with original plastic rivets.

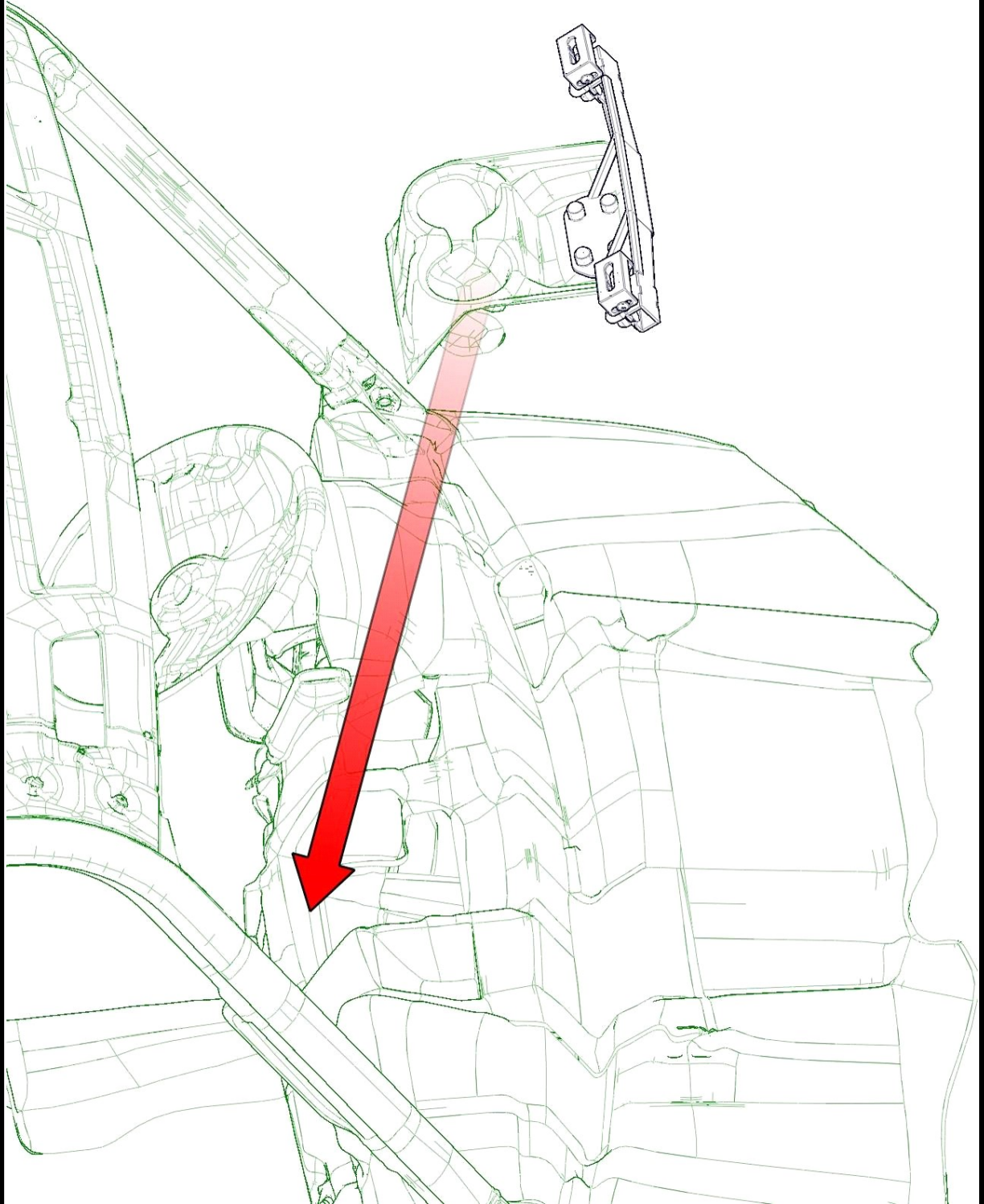

Place the front glass assembly onto the UTV roll cage.

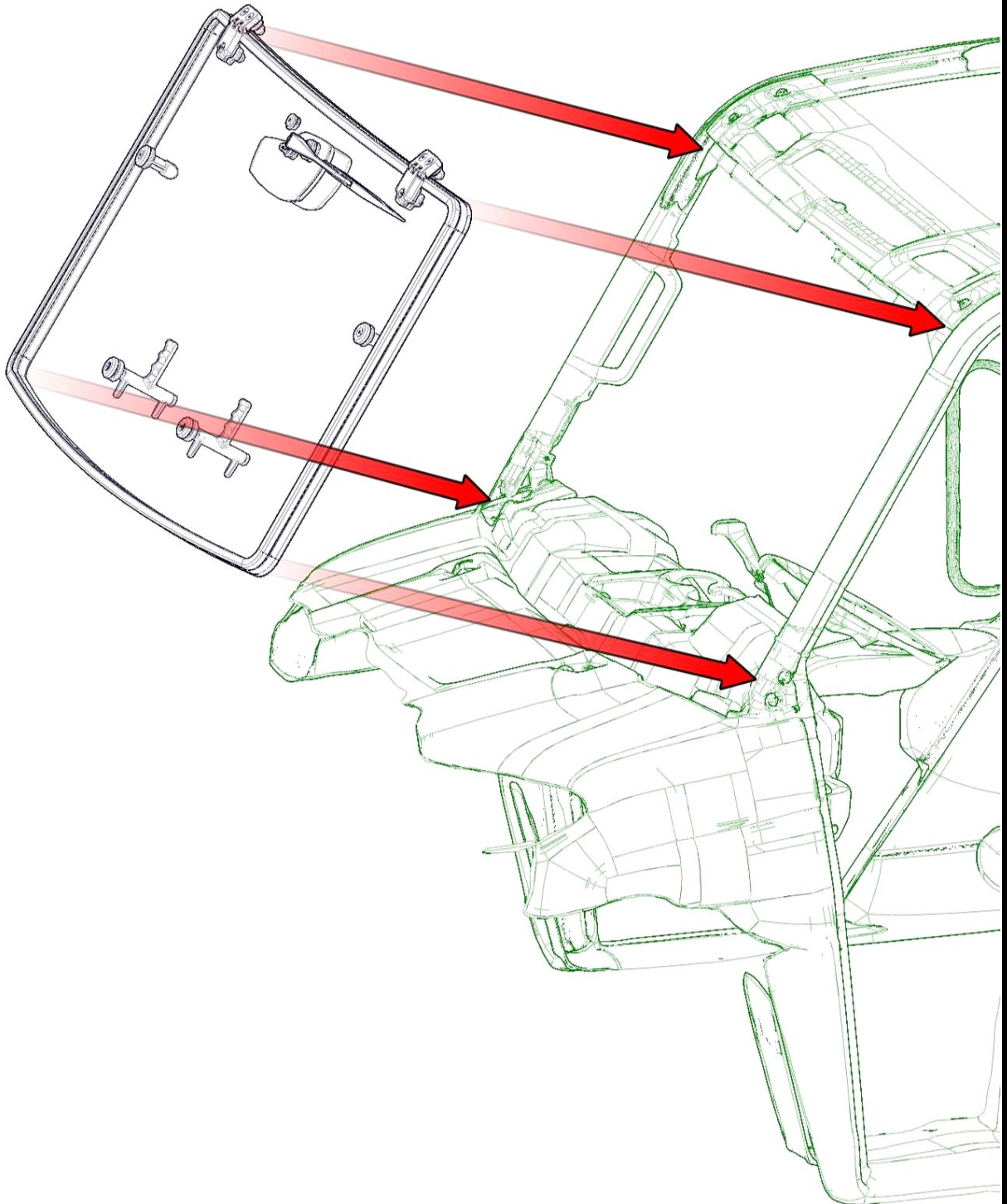

43

Adjust the front glass assembly in accordance with the original frame holes. Attach the front glass assembly with included fixing assemblies.

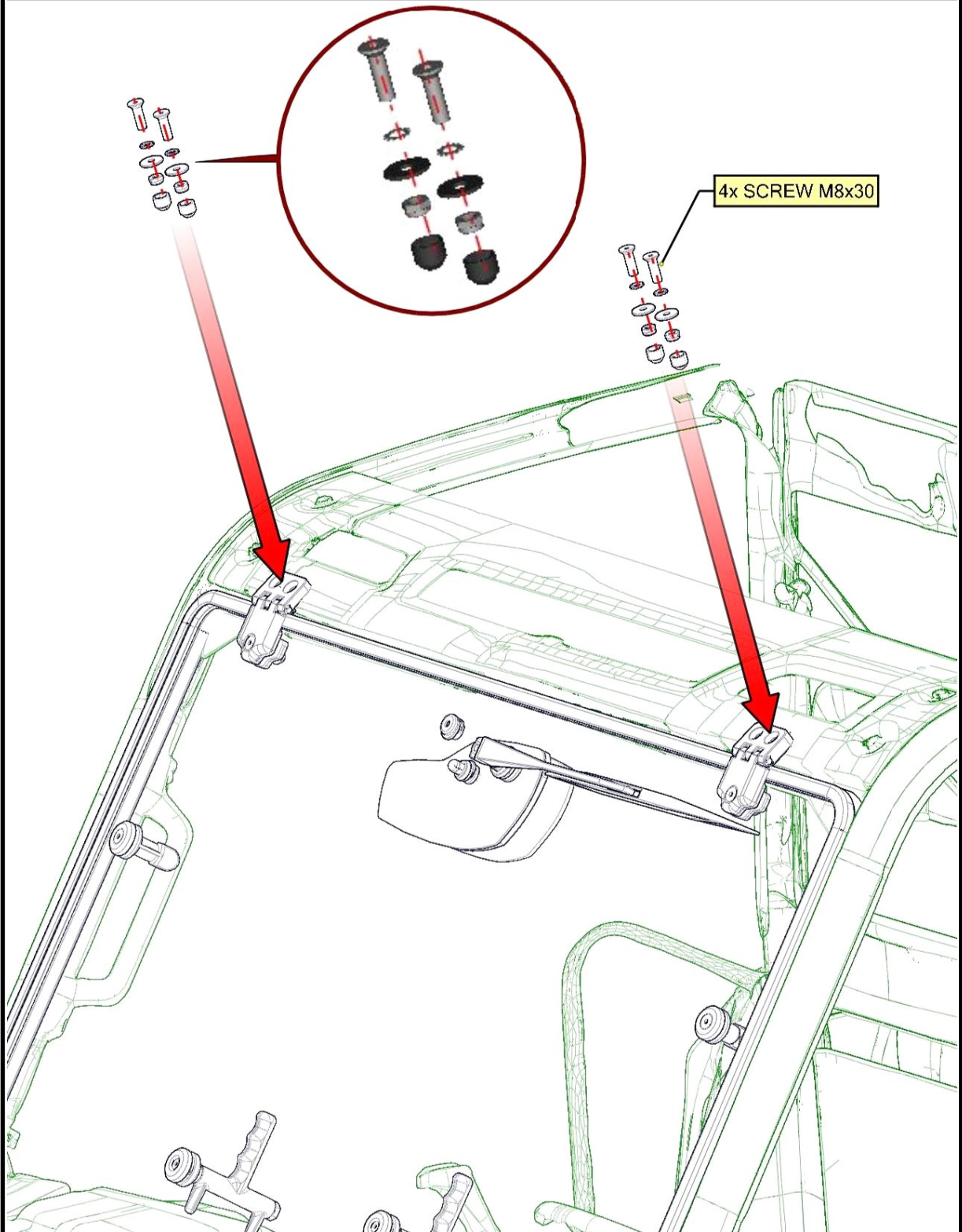

Mount the gas spring pin into the original frame hole. Hold the nut on position with nut wrench.

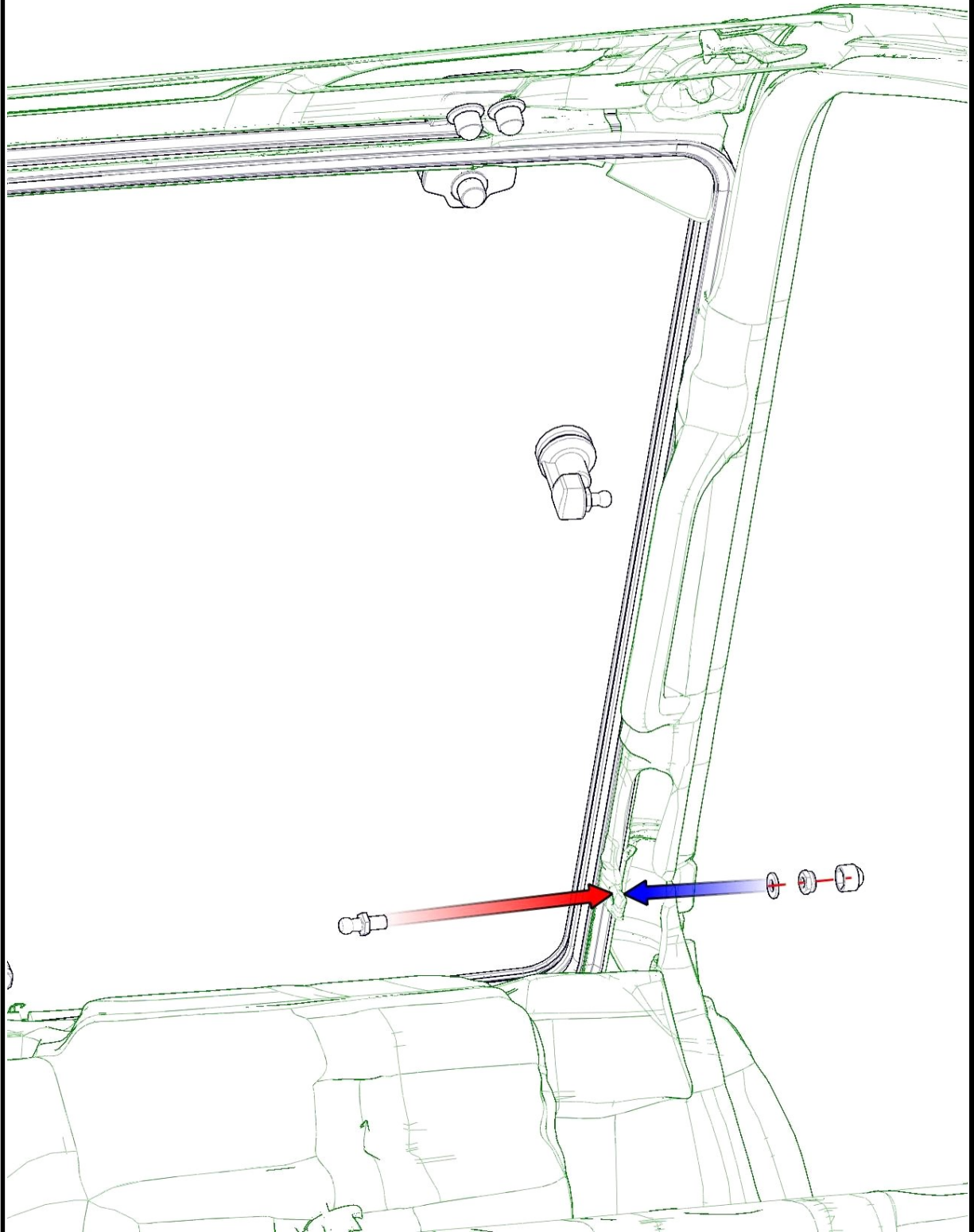

45

Install the gas spring onto the gas spring pins.

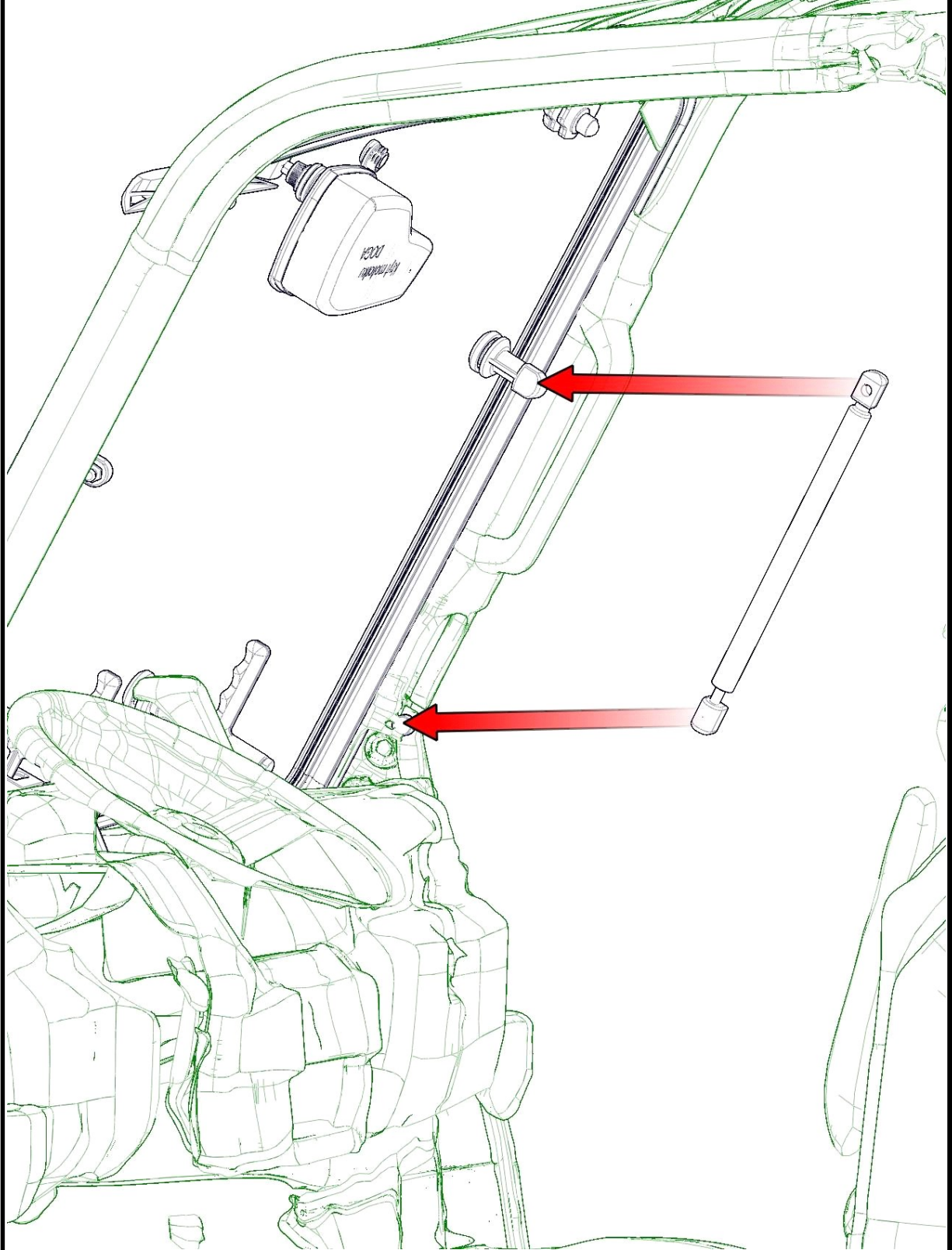

REAR PANEL

Loosen the rear panel holders clamping levers and turn the holders out of the way.

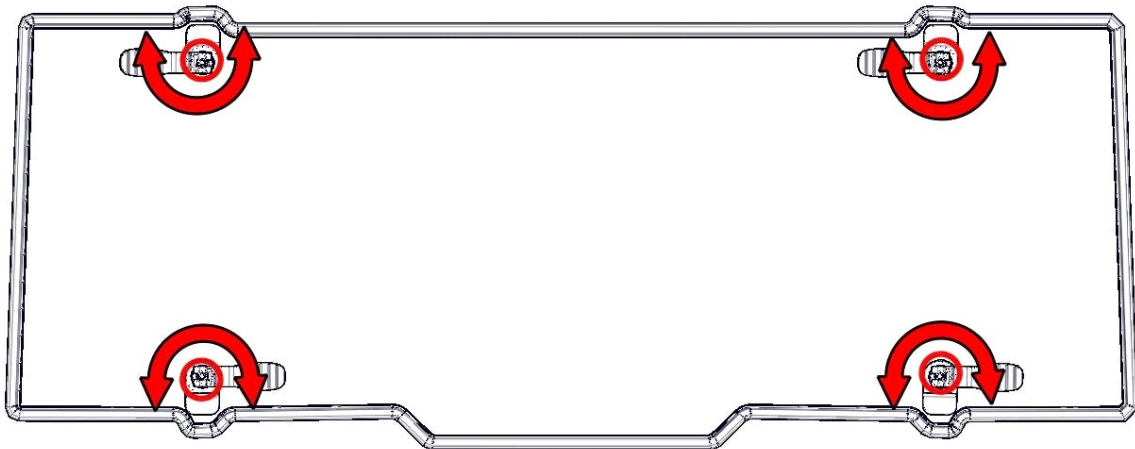

47

Place the rear panel onto the UTV roll cage.

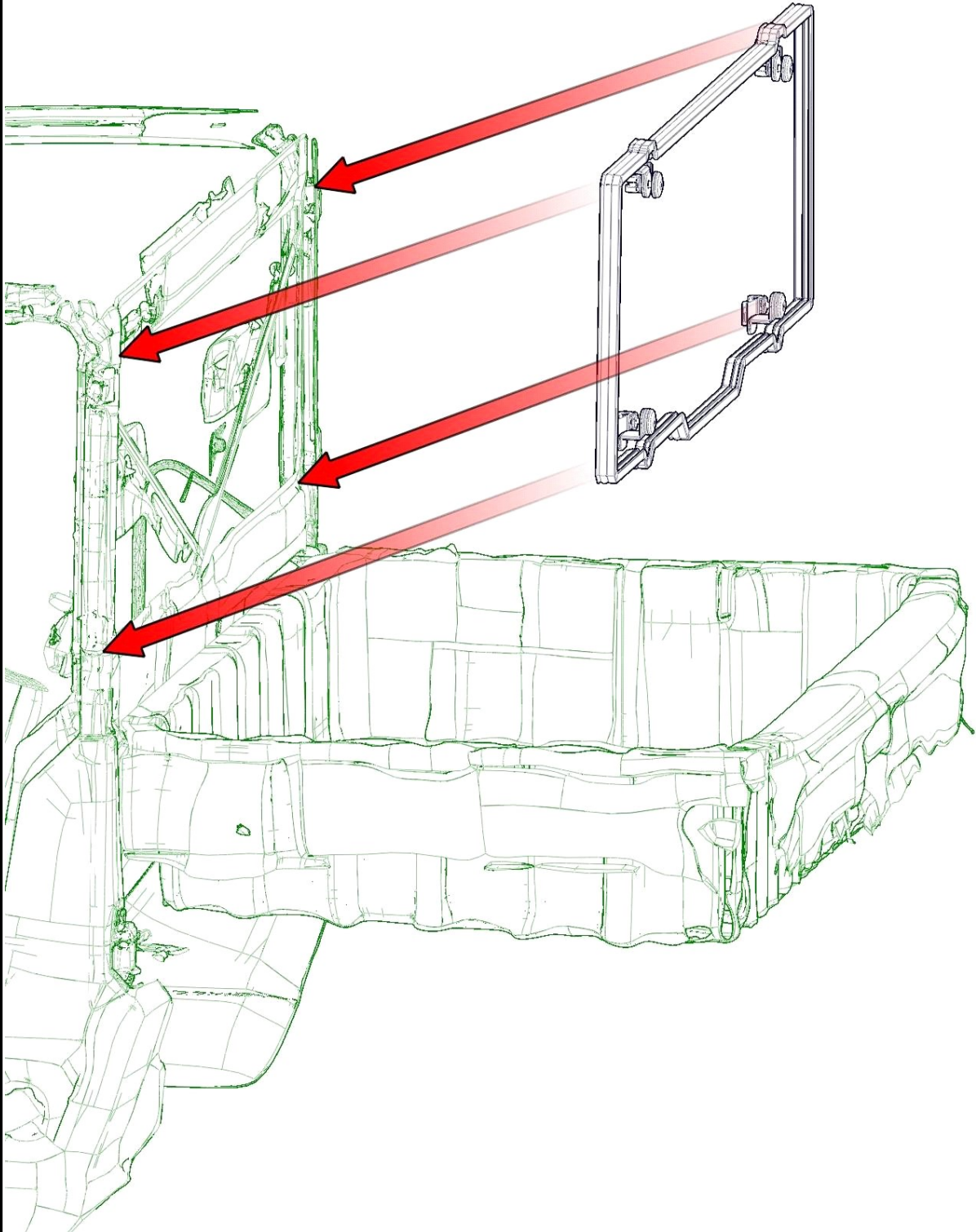

Adjust the rear panel to the best position.

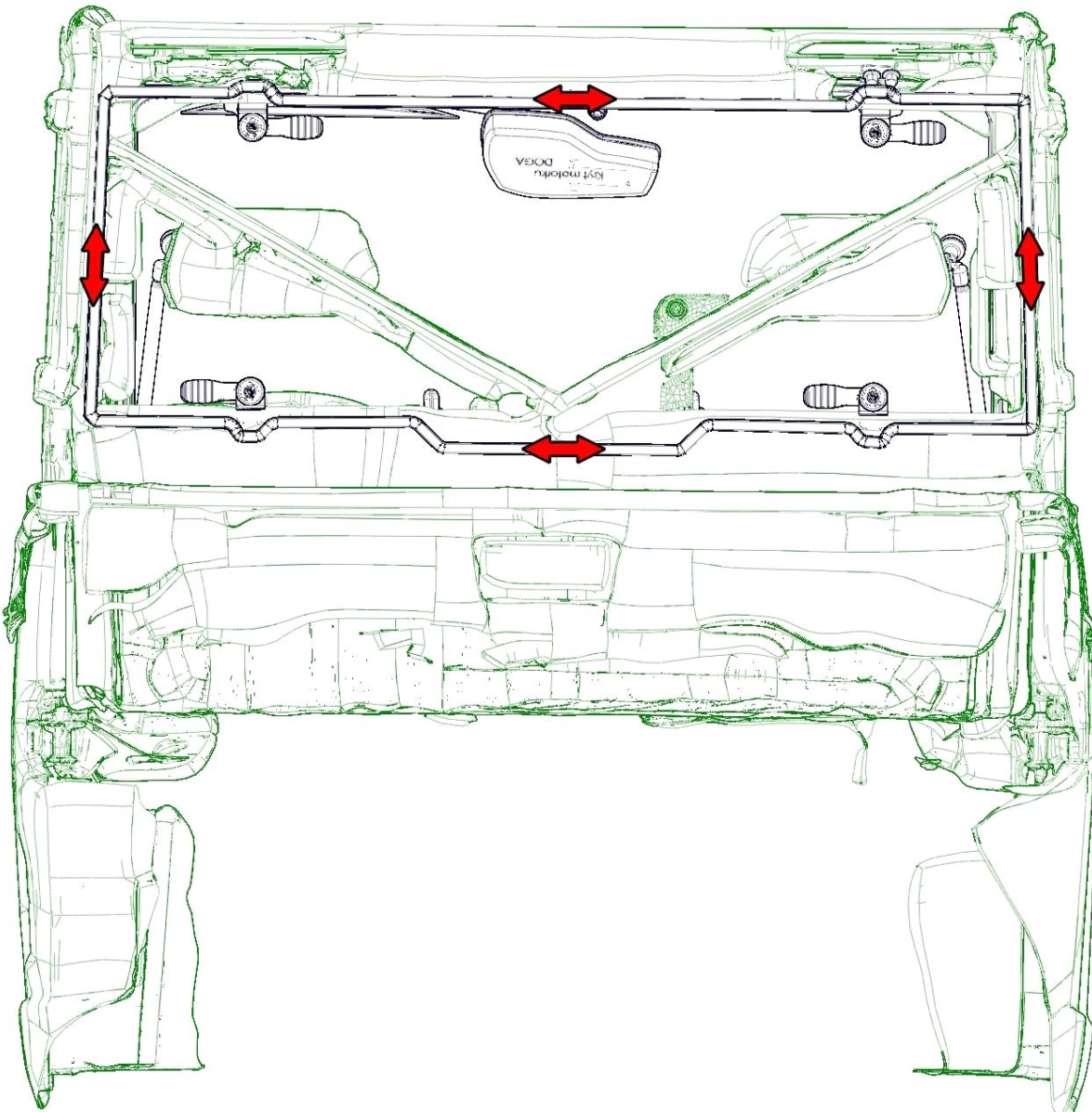

49

Turn the rear panel holders to the function position and tighten the clamping levers.

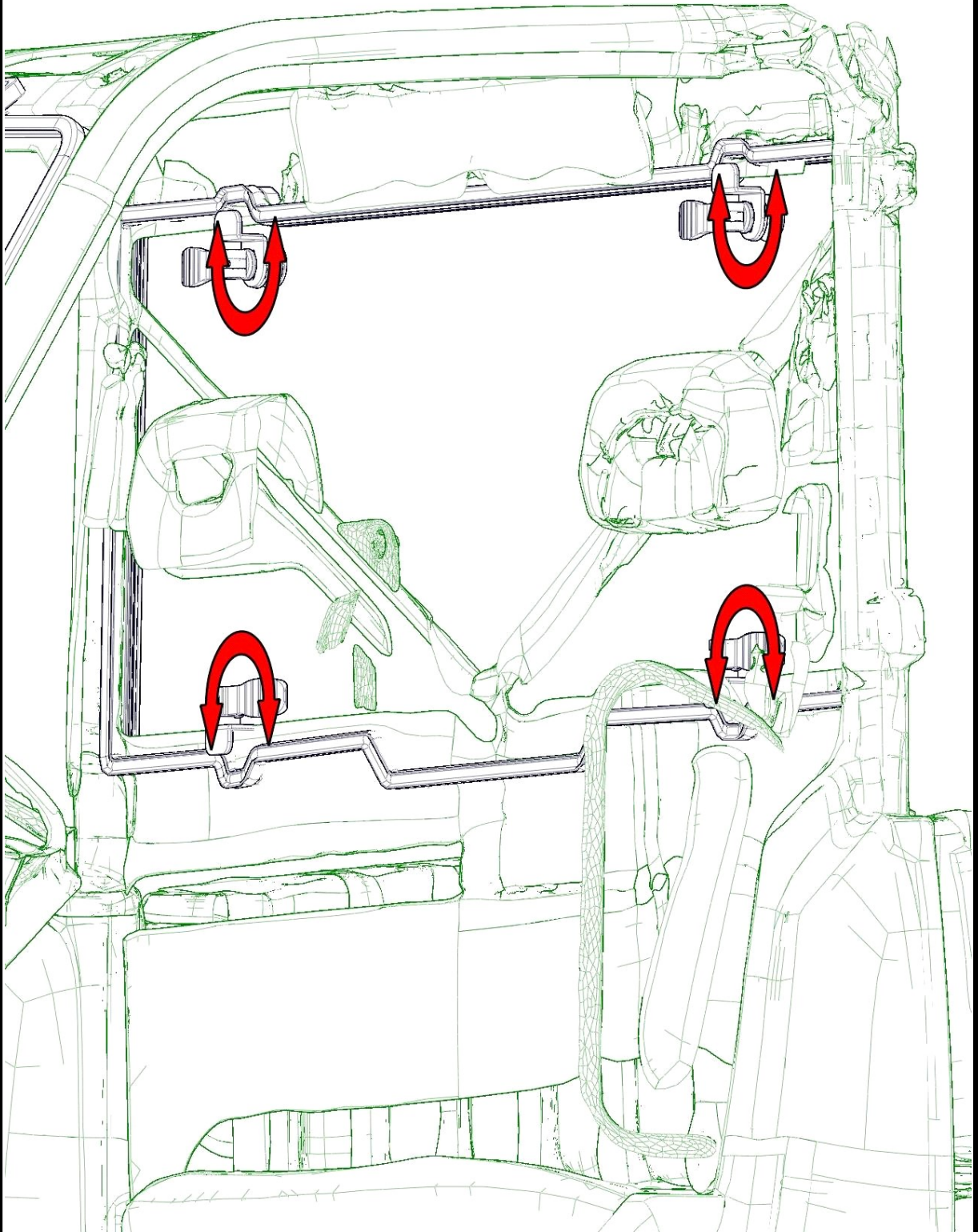

50

LEFT DOOR + RIGHT DOOR

Mount the left door upper hinge onto the UTV roll cage with included fixing assemblies. The welded part with nuts must be placed behind the frame bracket.

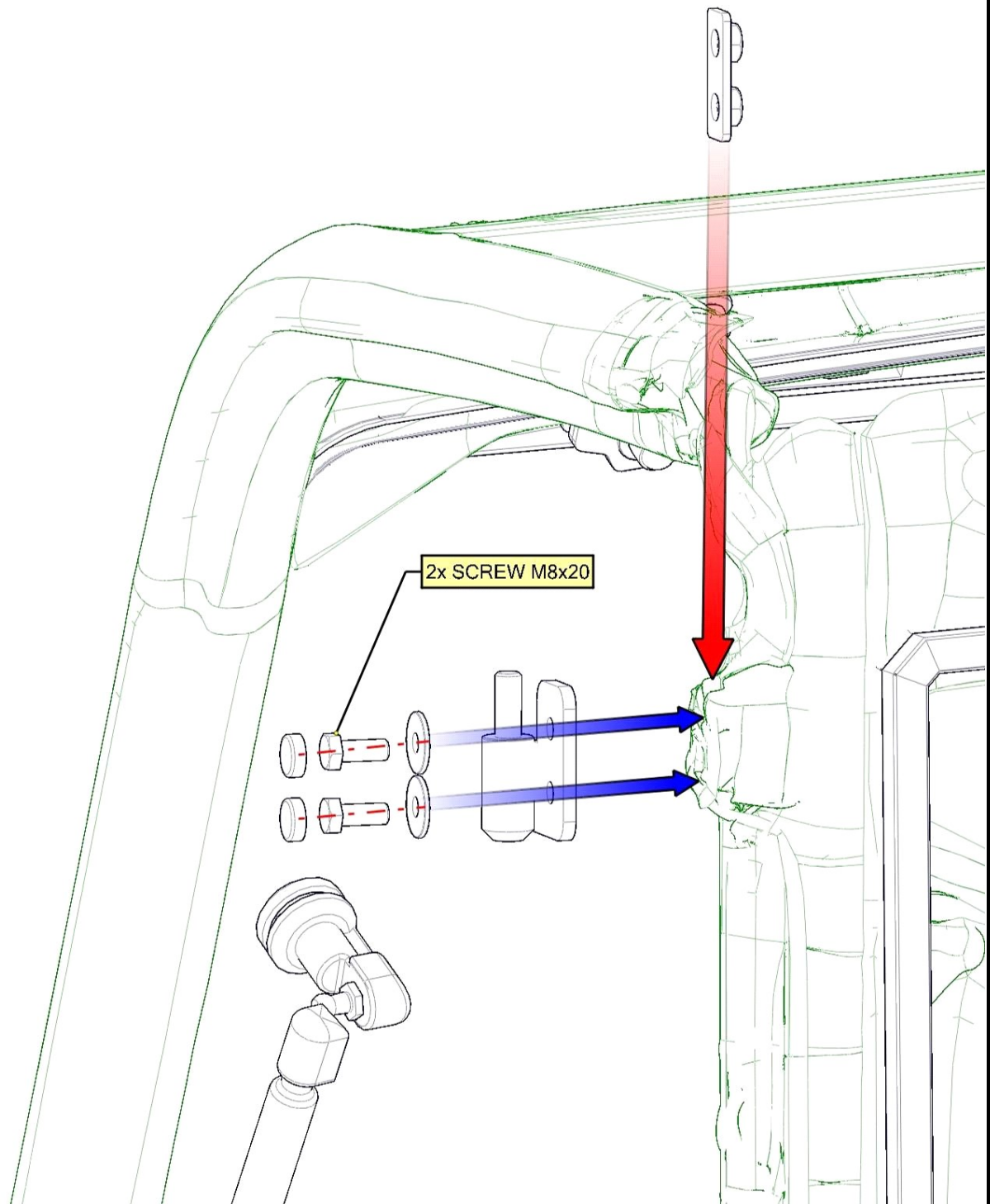

51

Place the left door bottom hinge onto the UTV roll cage in accordance with original holes. The cargo bed must be tilted before installation.

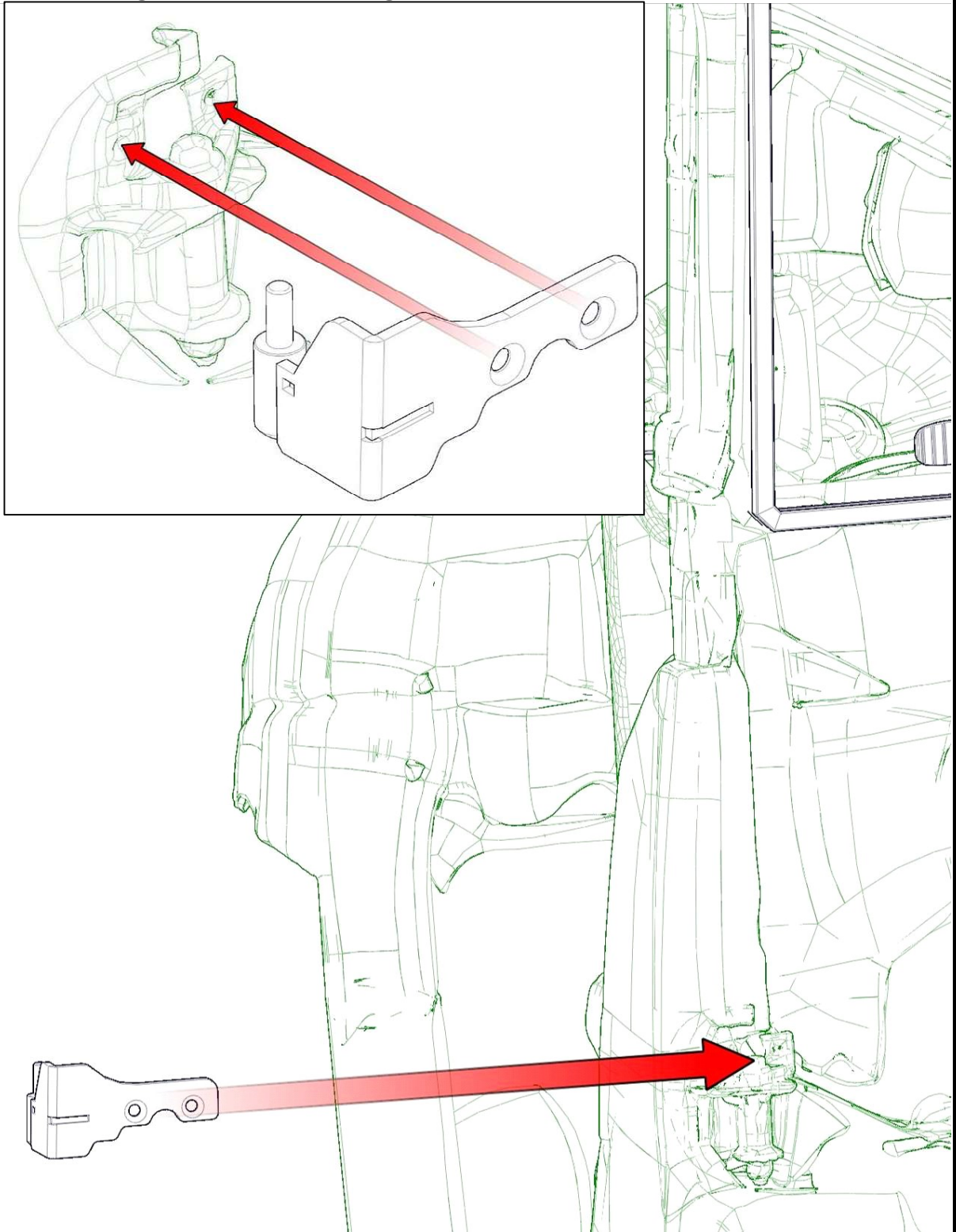

Attach the left door bottom hinge with included screws.

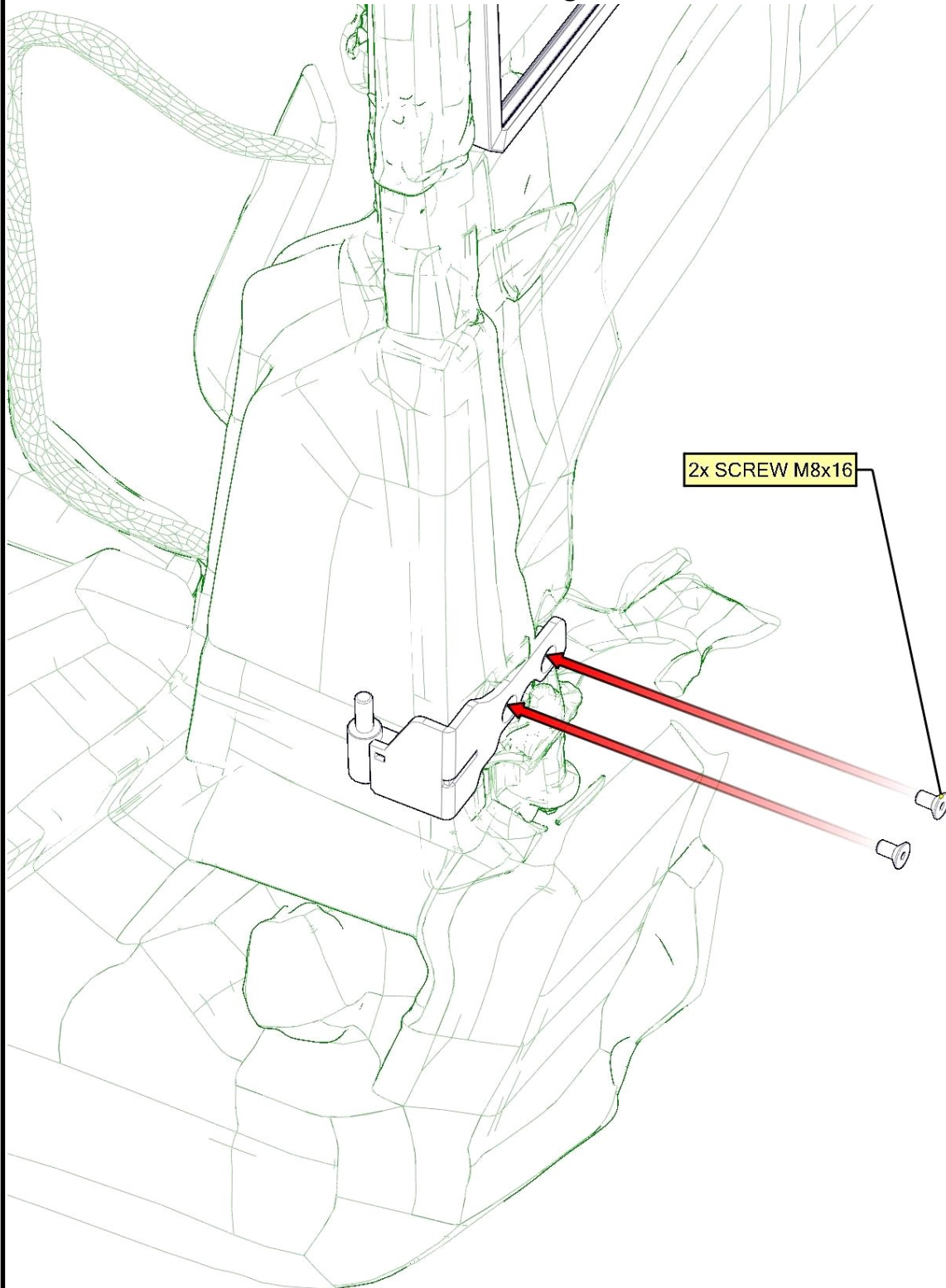

Lubricate the hinges pins and install the left door onto the hinges.

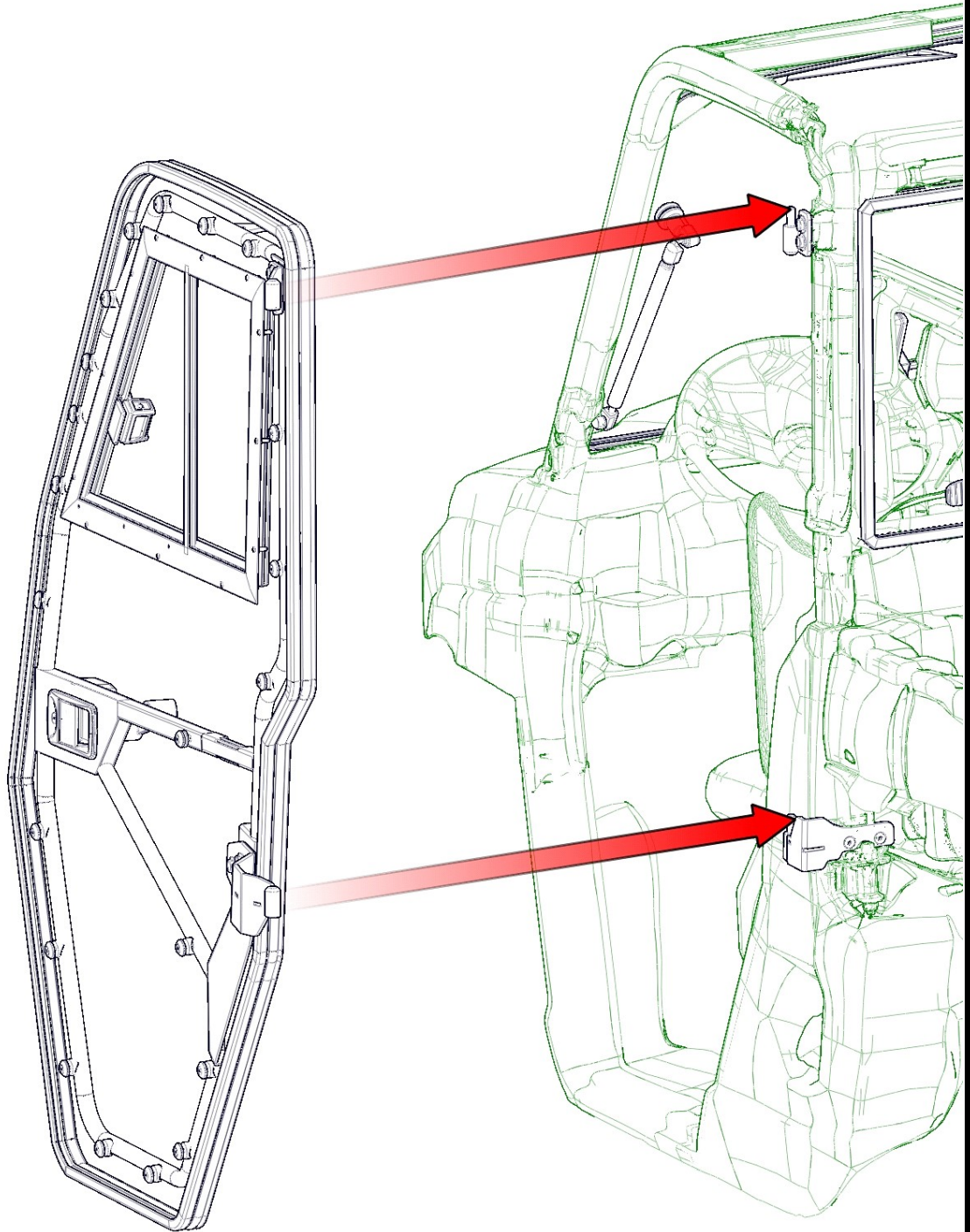

54

If necessary loosen the door hinges screws (red circles) and adjust the door to the best position.

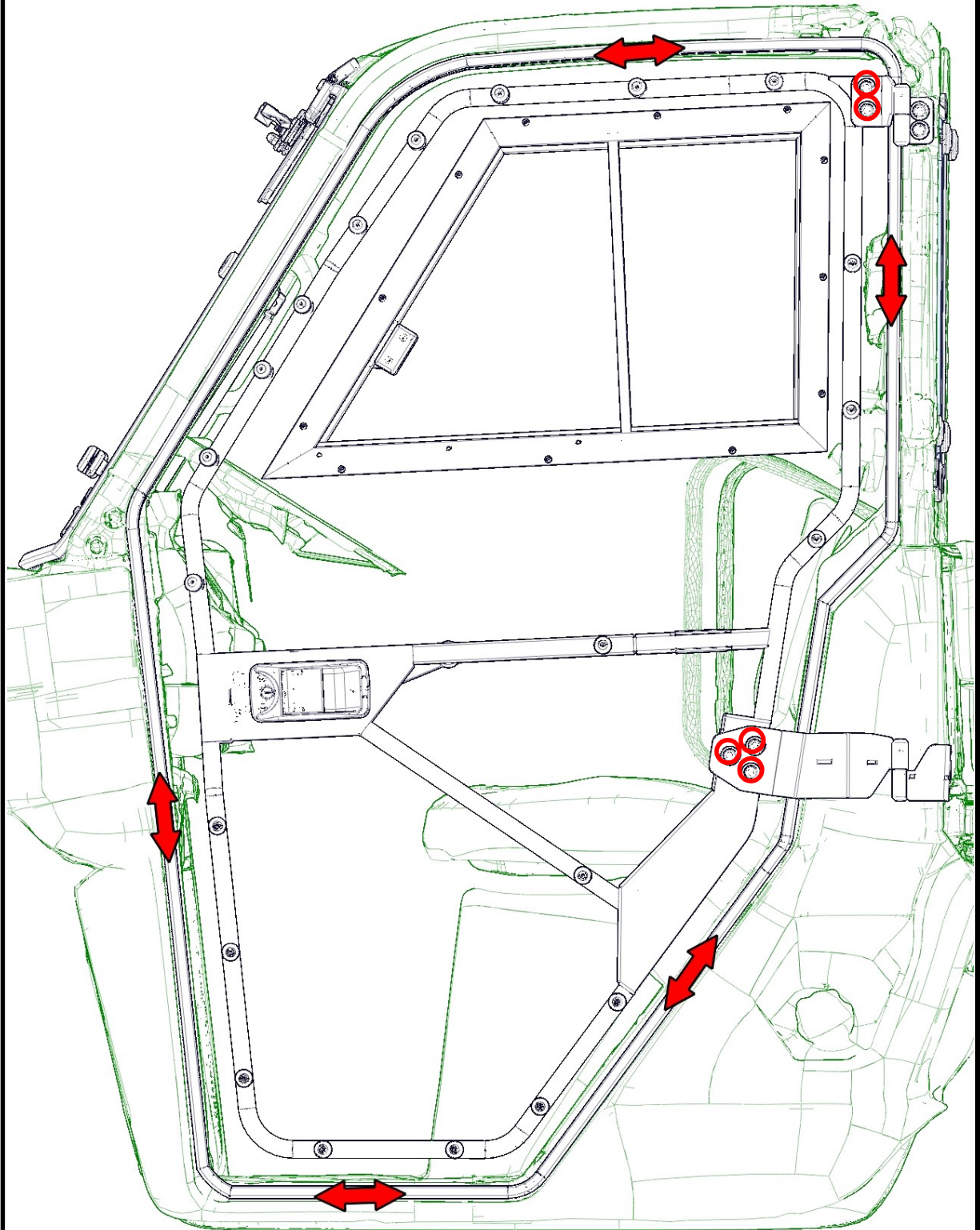

55

Place the left door stop assembly onto the UTV frame in accordance with the original frame holes. Replace the original screws with included fixing assemblies.

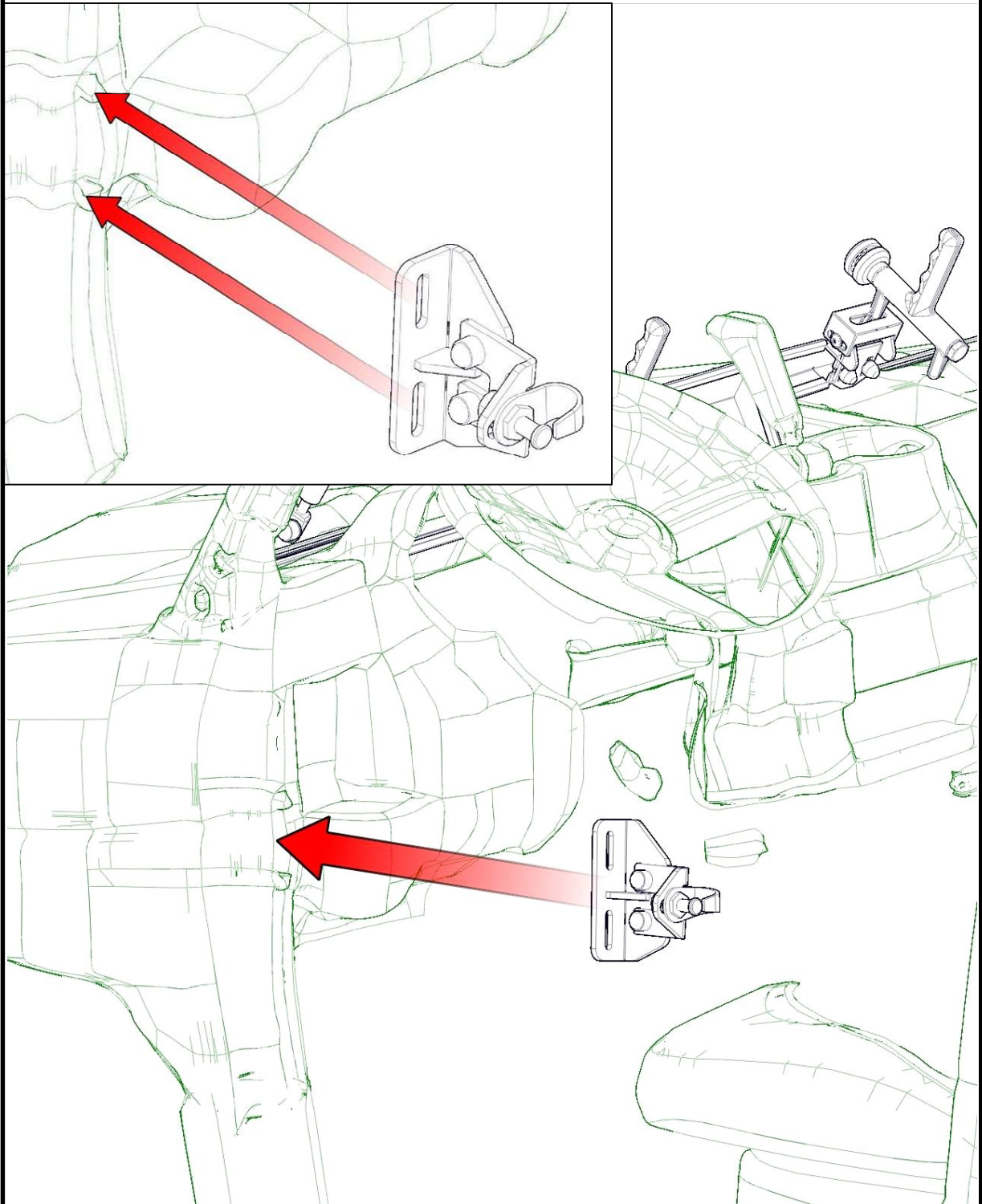

Attach the left door stop assembly with included washers, screws and covers.

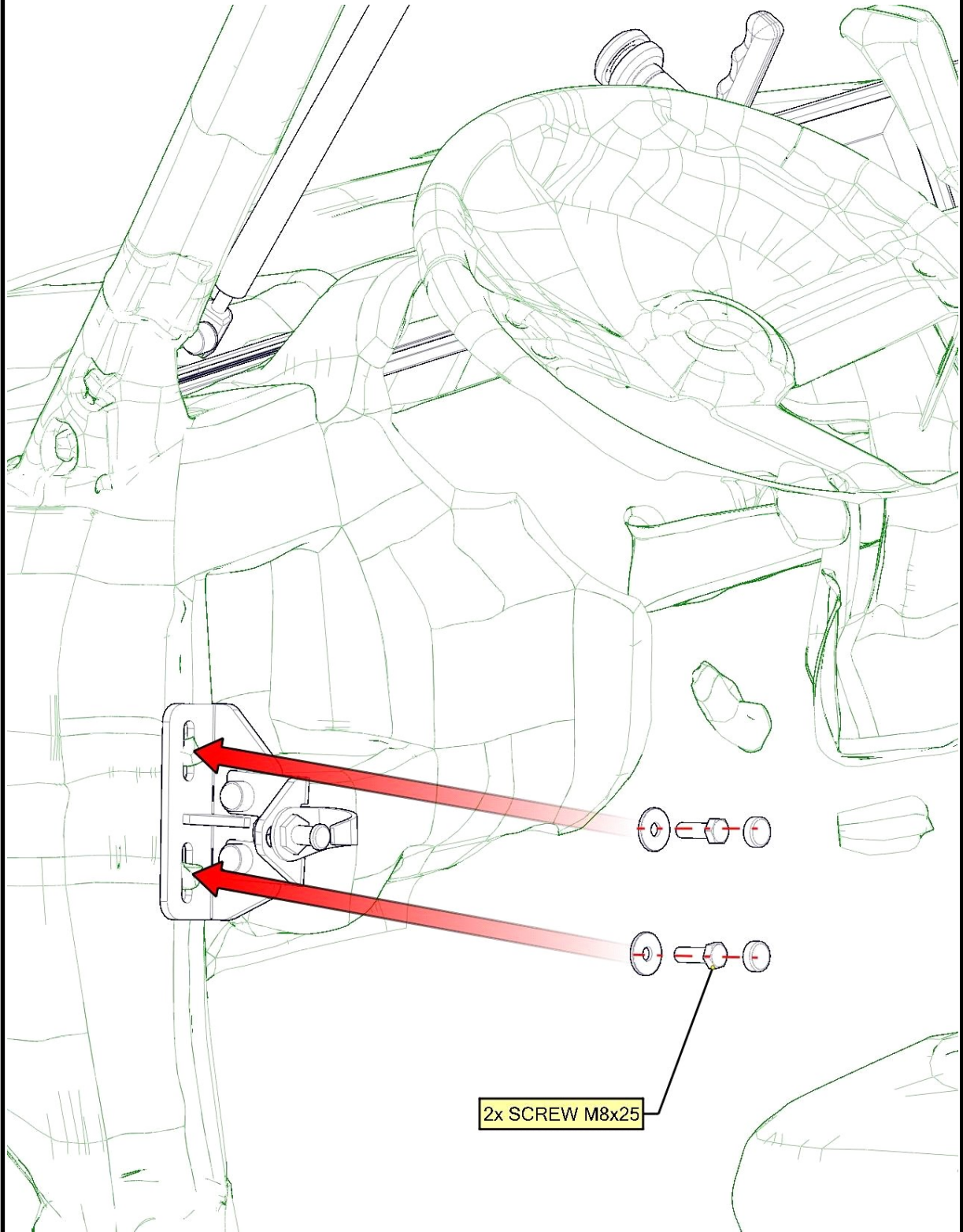

57

Adjust the door stop holder and door stop to the best position with the door. **If you have adjusted the door stop correctly, when you close the door slowly you will hear 2 clear metallic clicks.**

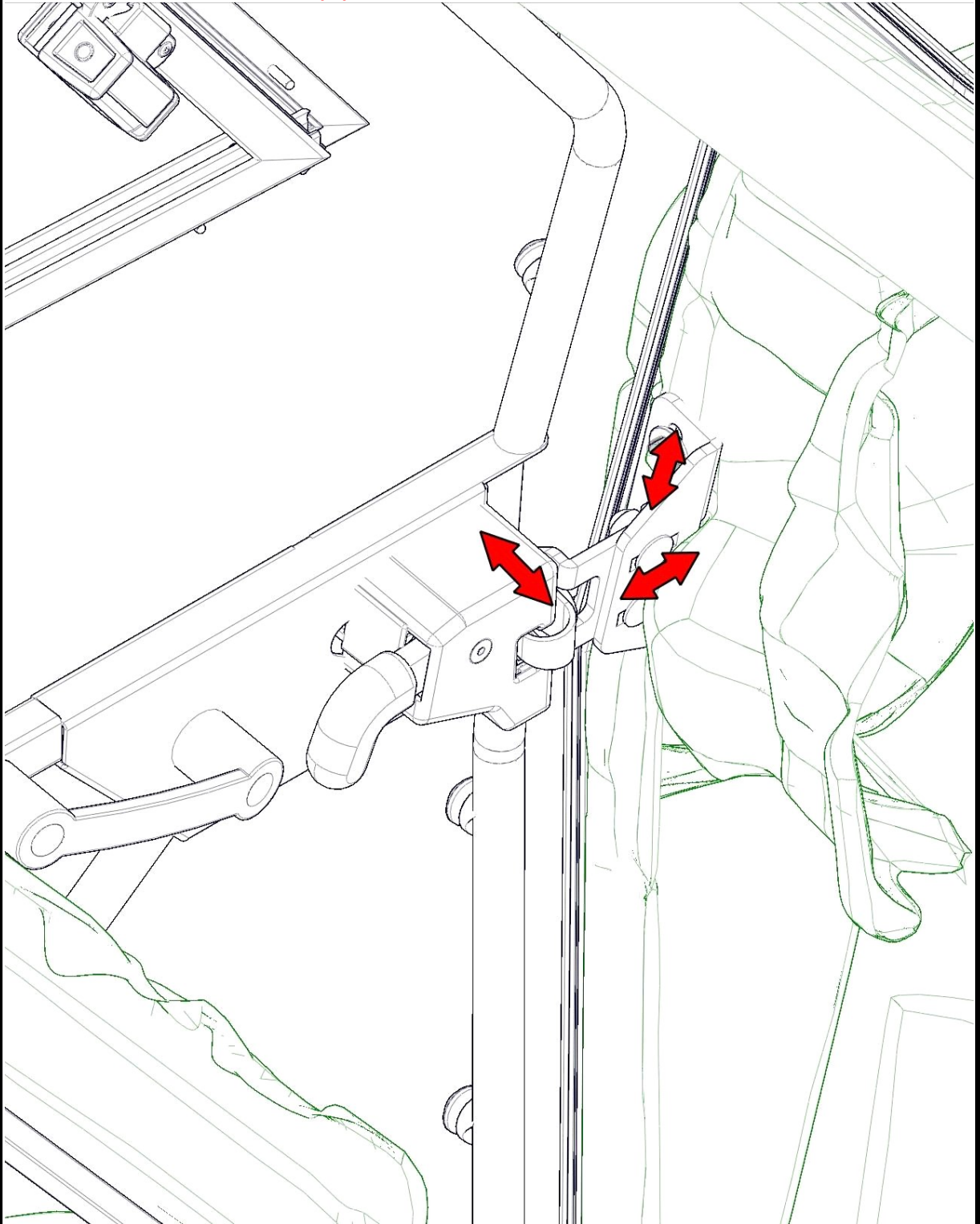

58

Place the left door gas spring holder onto the UTV roll cage.

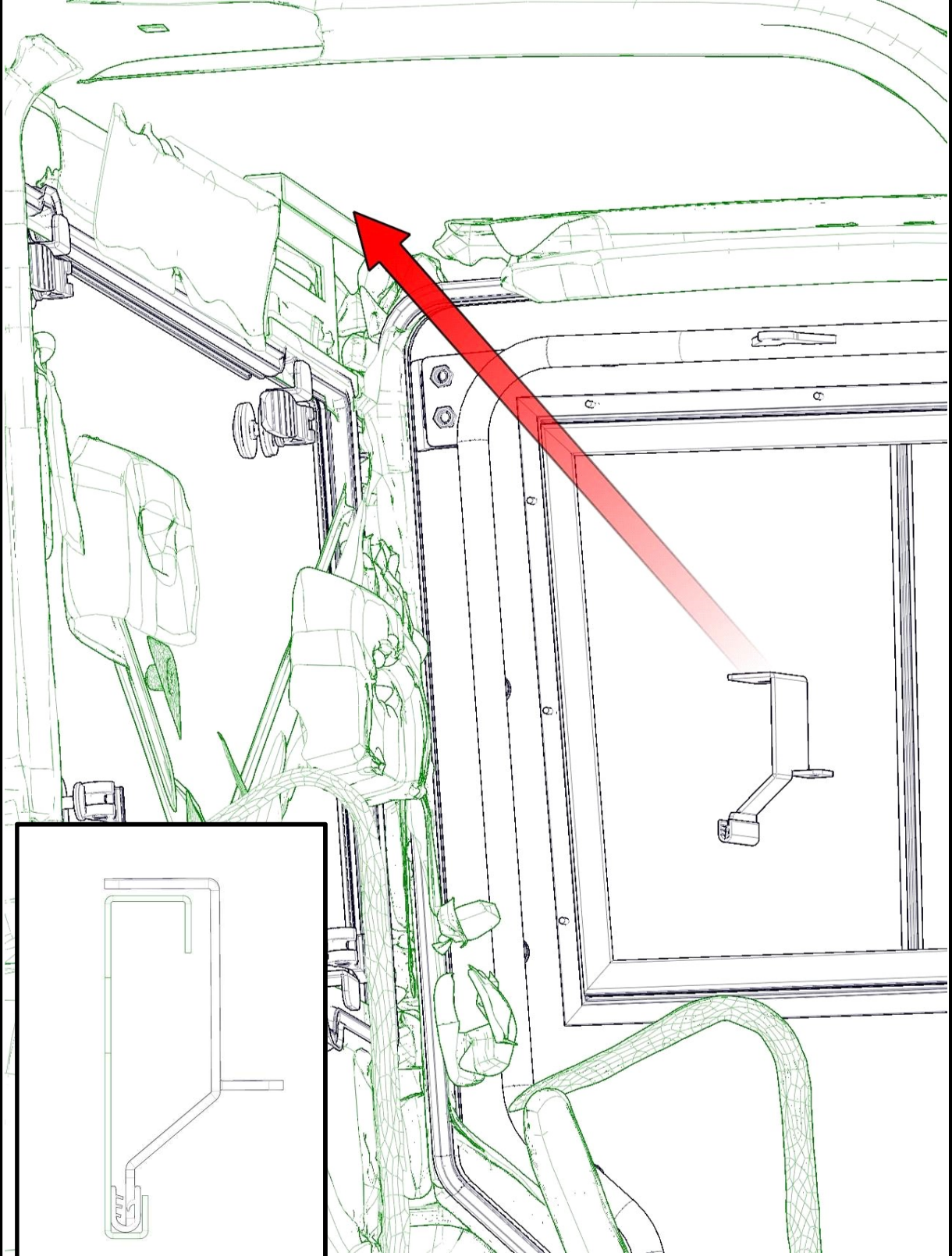

Place the welded fixing part onto the UTV roll cage in accordance with the hole.

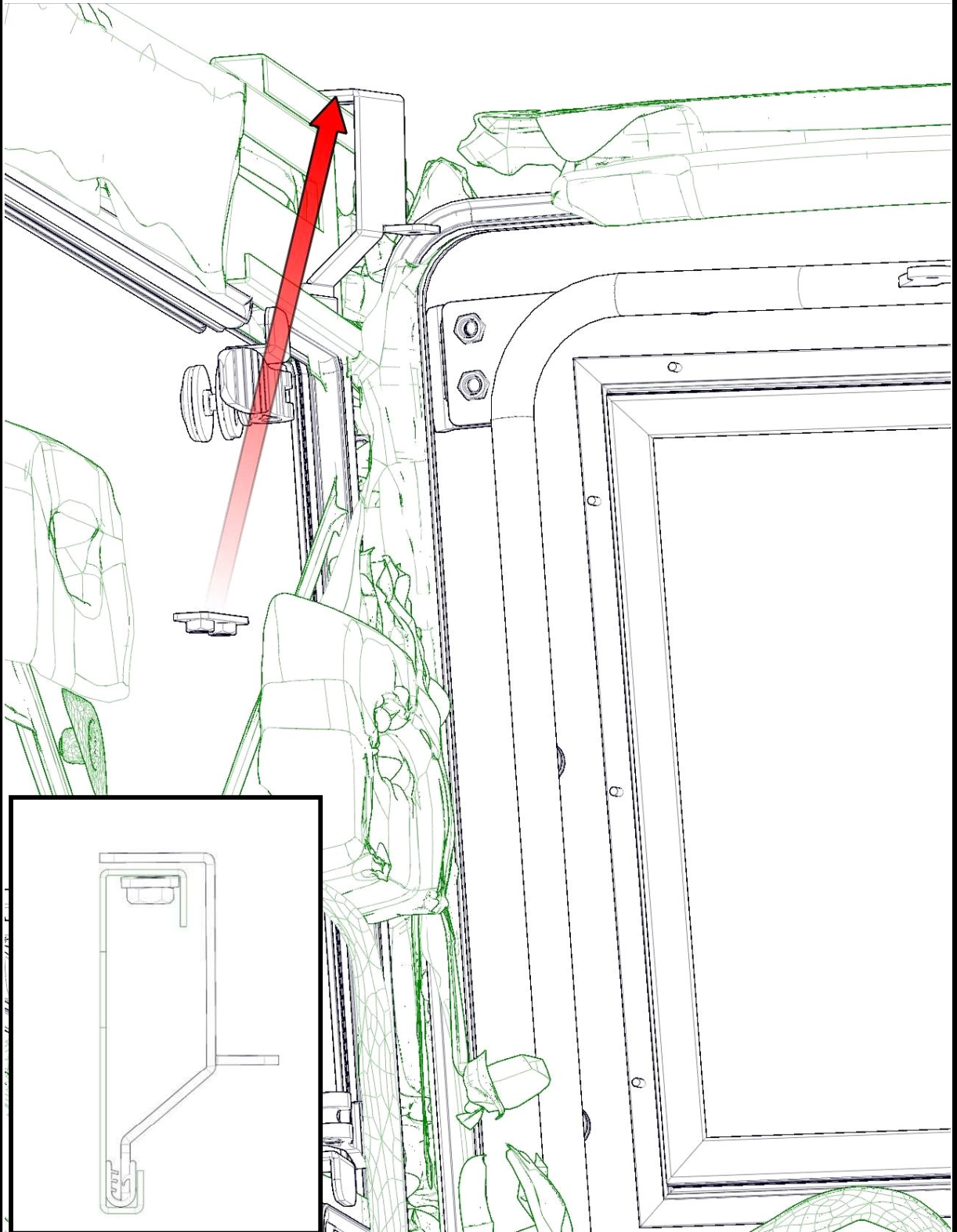

60

Attach the left door gas spring holder with included washer, screw and cover.

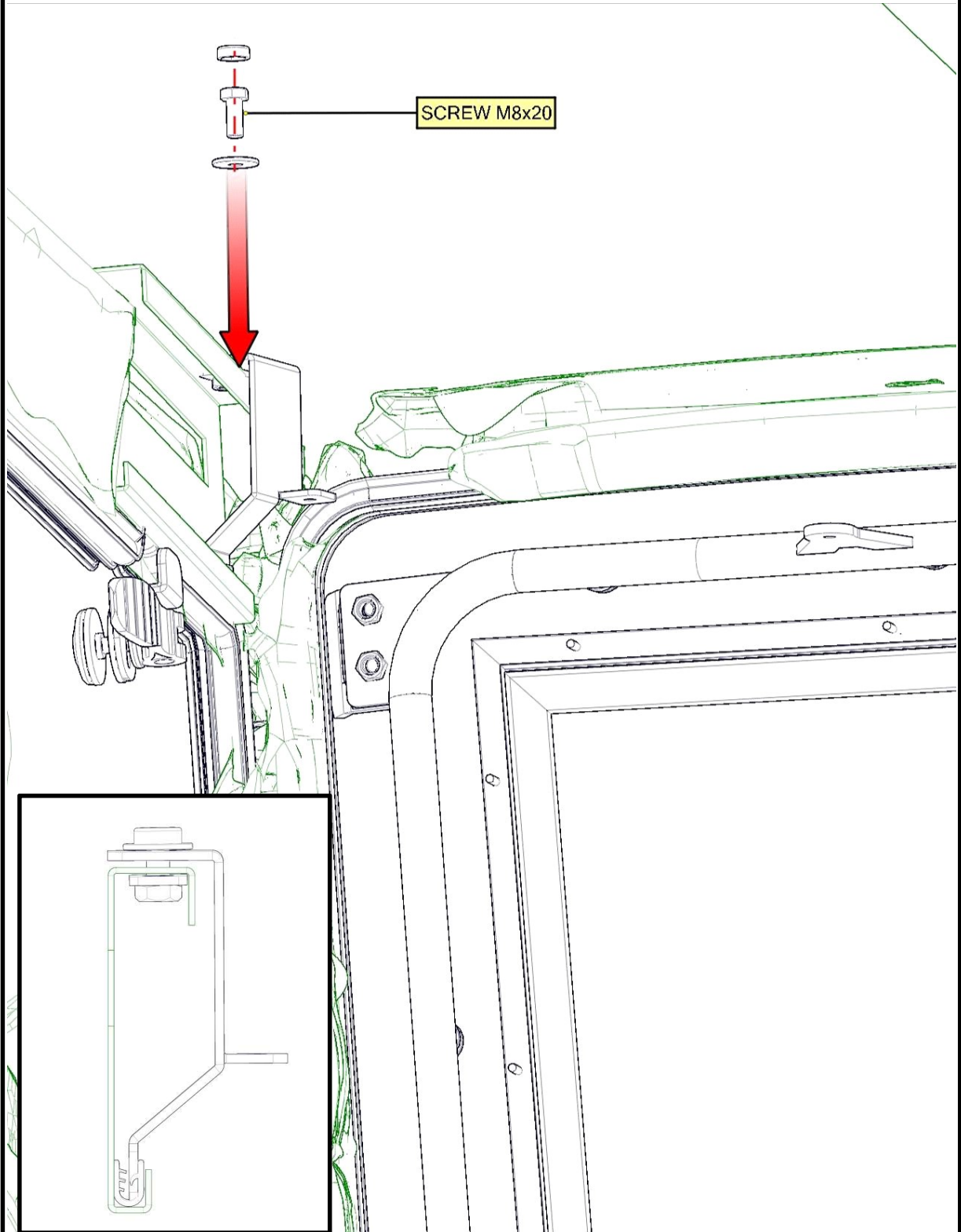

61

Mount the gas spring pins into the gas spring holders.

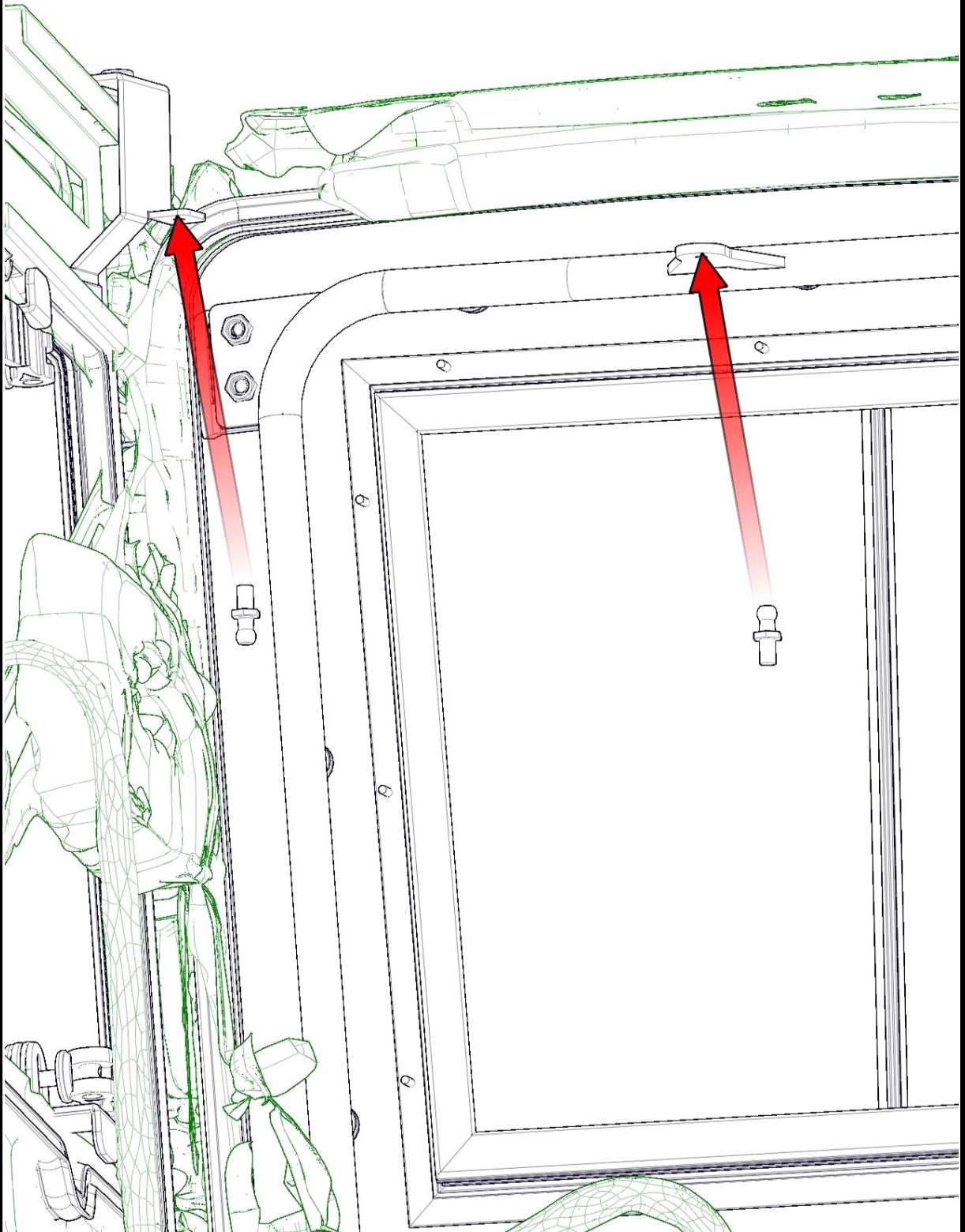

62

Install the gas spring onto the gas spring pins.

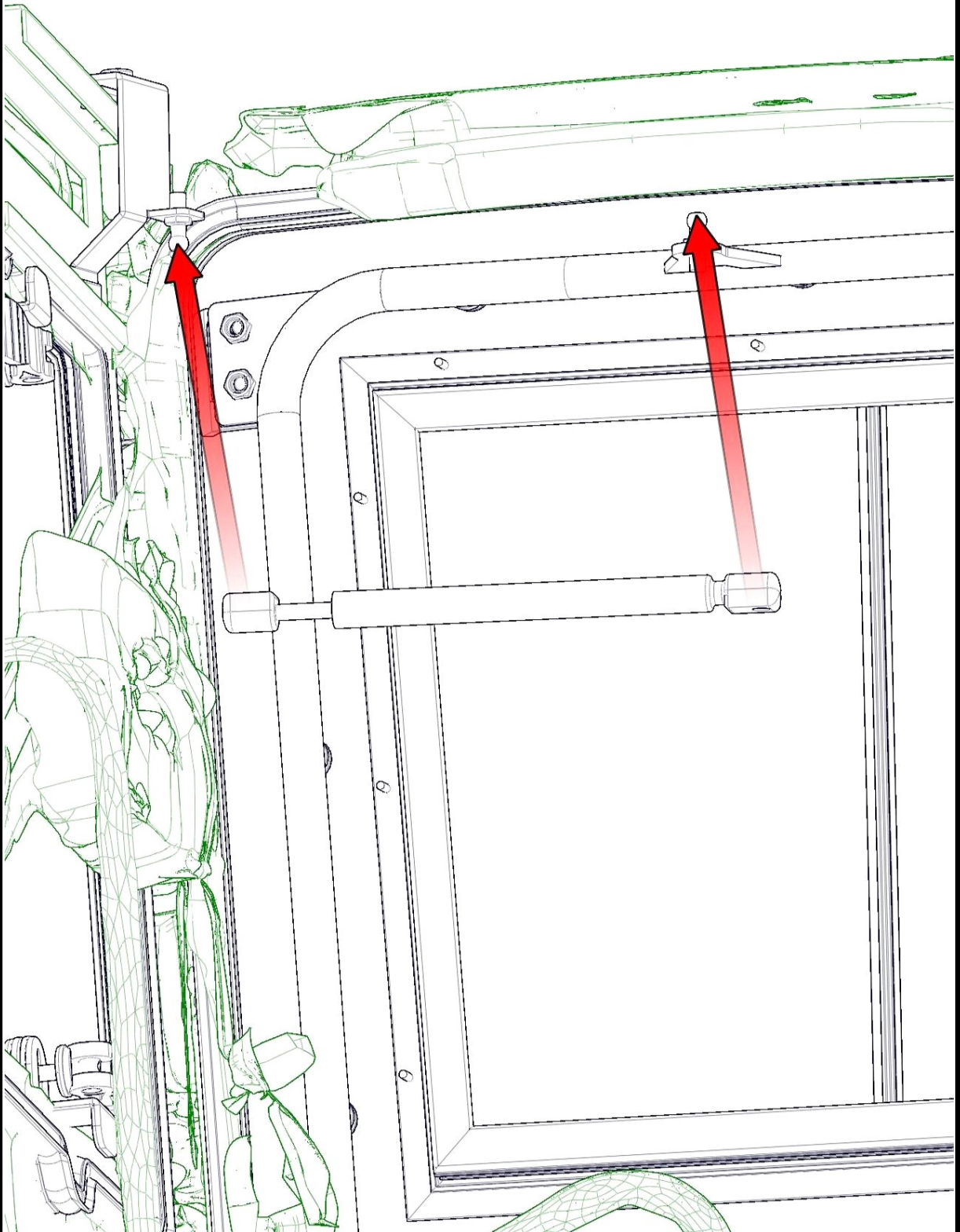

63

Secure the gas spring pins with included washers, nuts and covers.

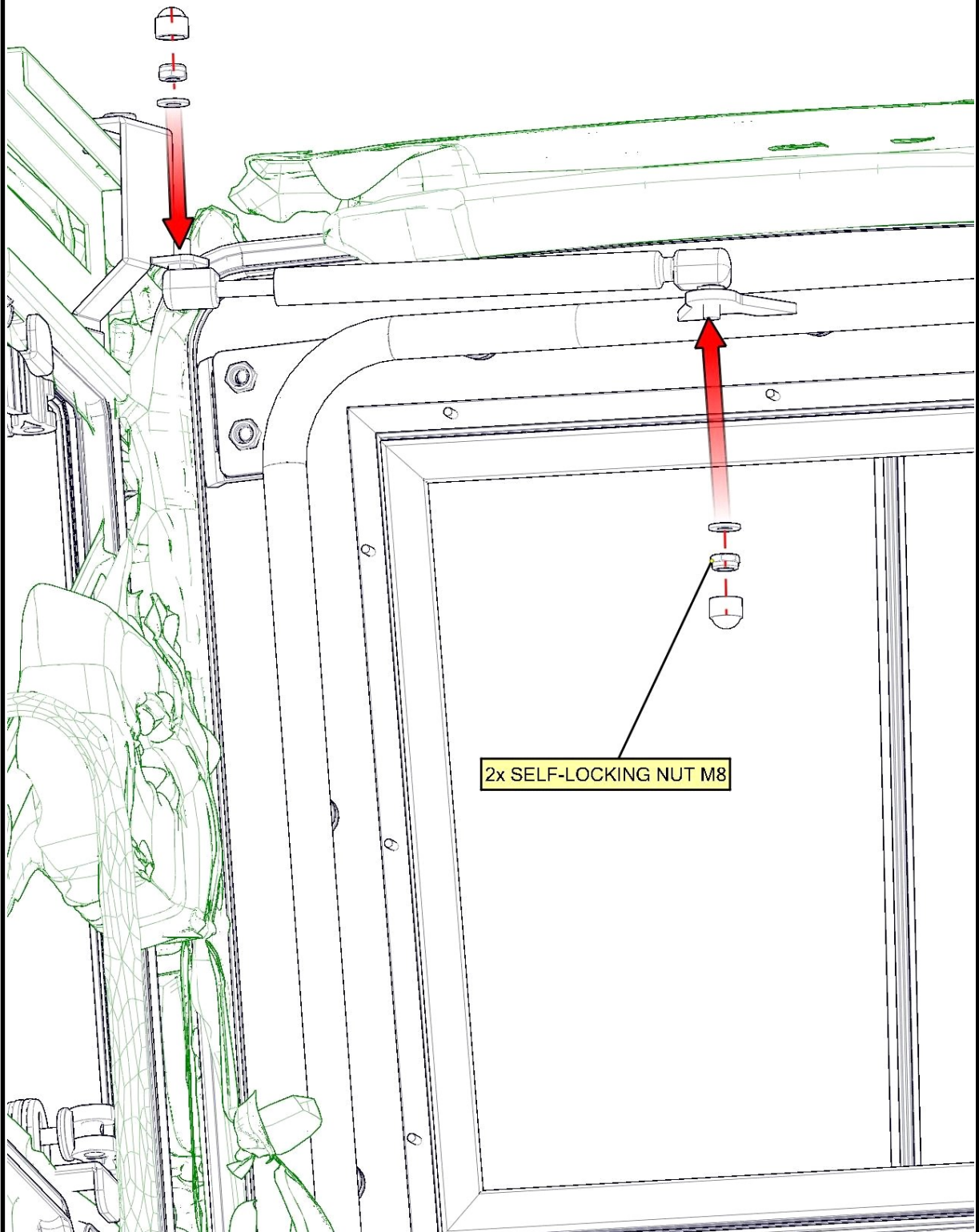

Loosen the screws of two assemblies for the rearview mirror attachment.

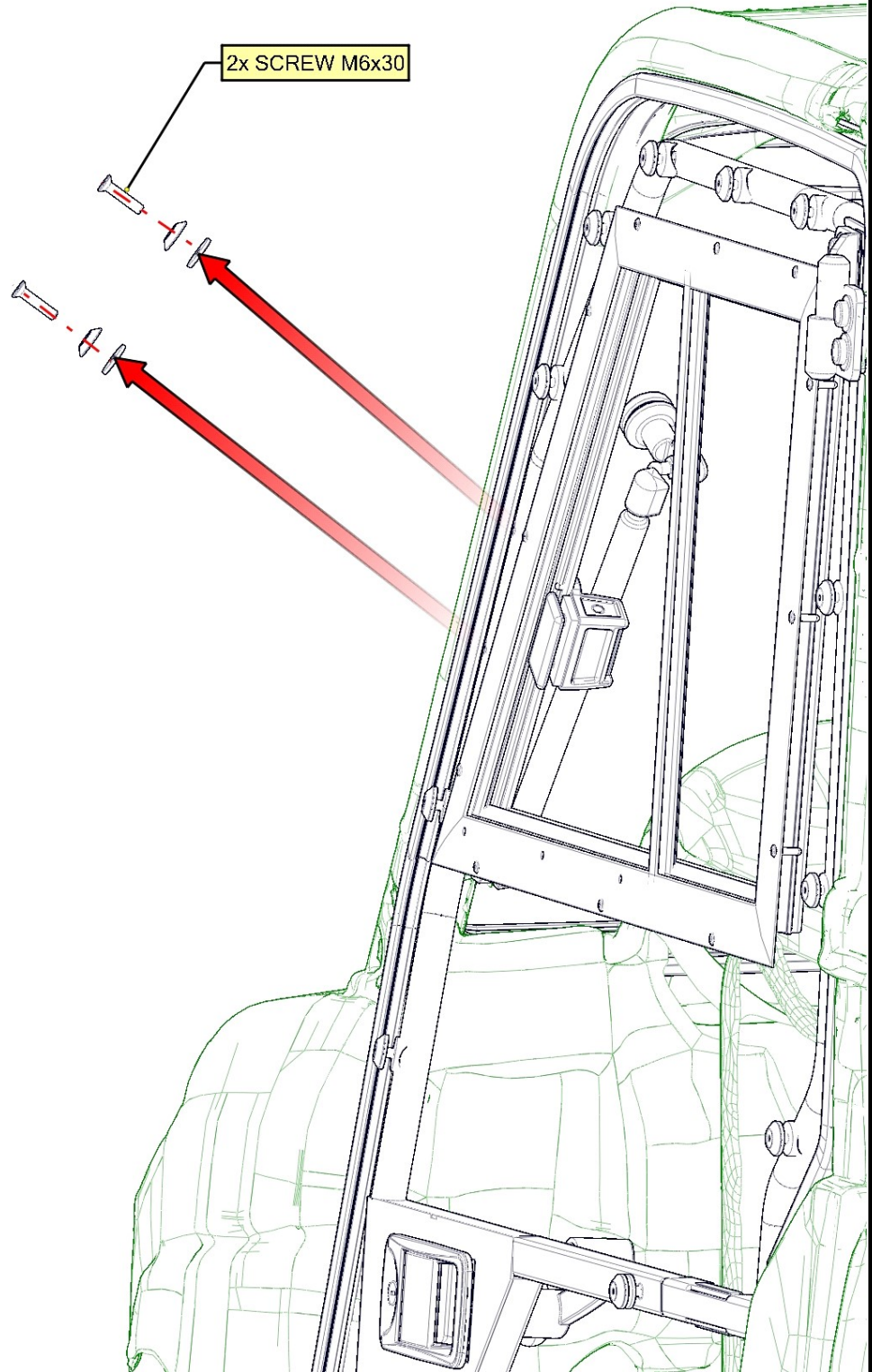

65

Place the rear view mirror onto the polycarbonate in accordance with the holes. Attach the rear view mirror with included screws and washers.

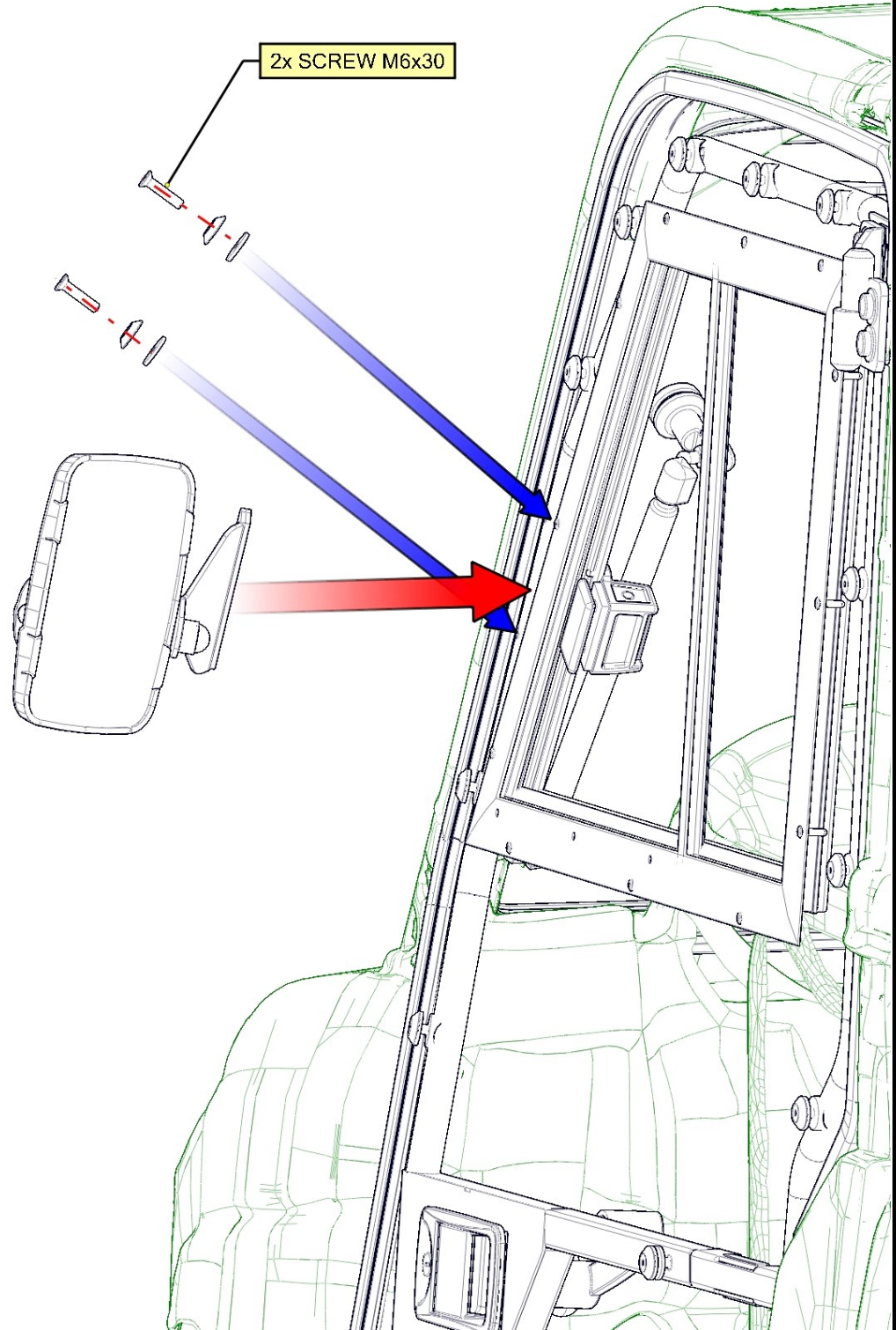

Repeat the previous steps with right door assembly.

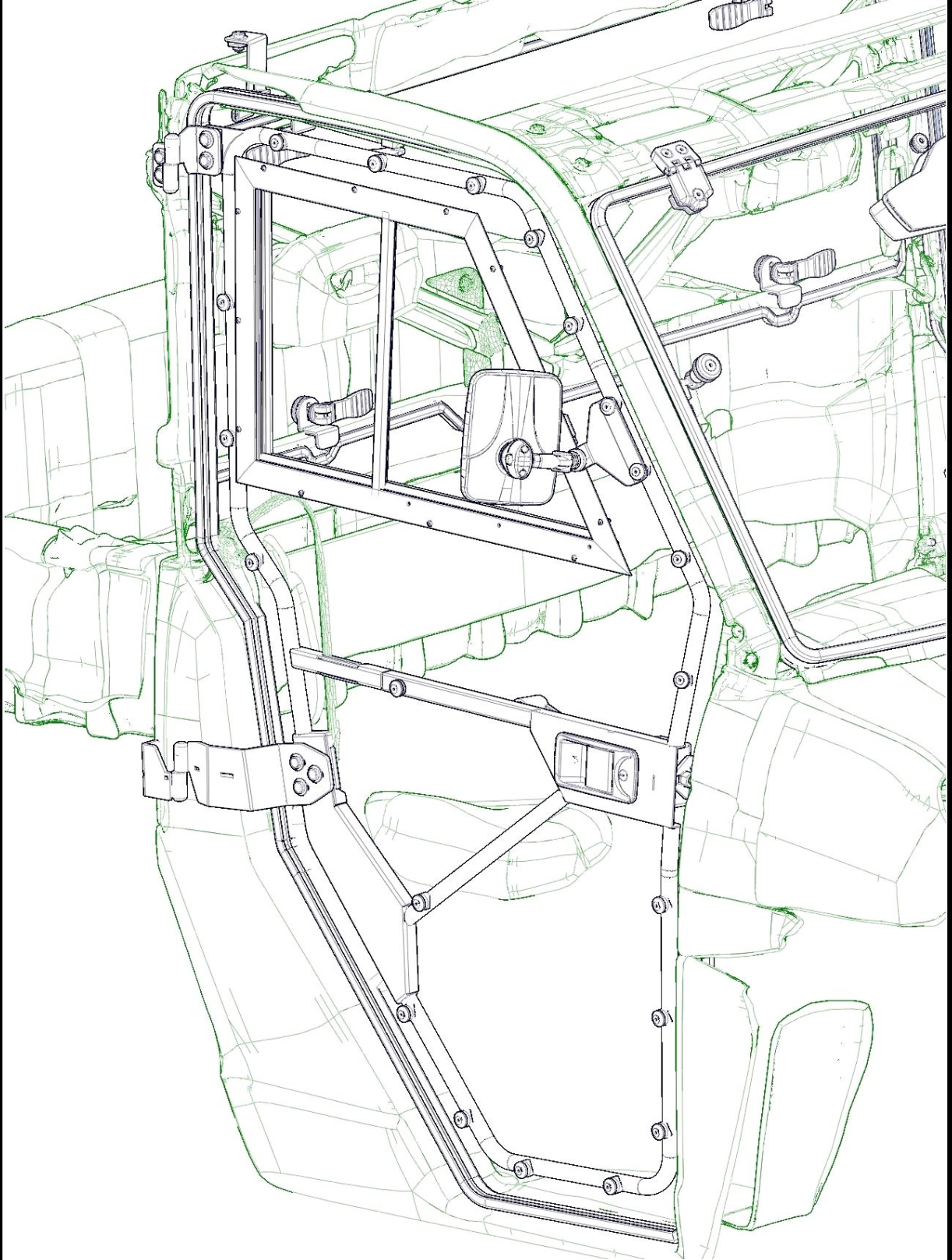

67

ROOF

Loosen the roof panel holders clamping levers. Turn the holders out of the way. Place the roof panel onto the UTV roll cage.

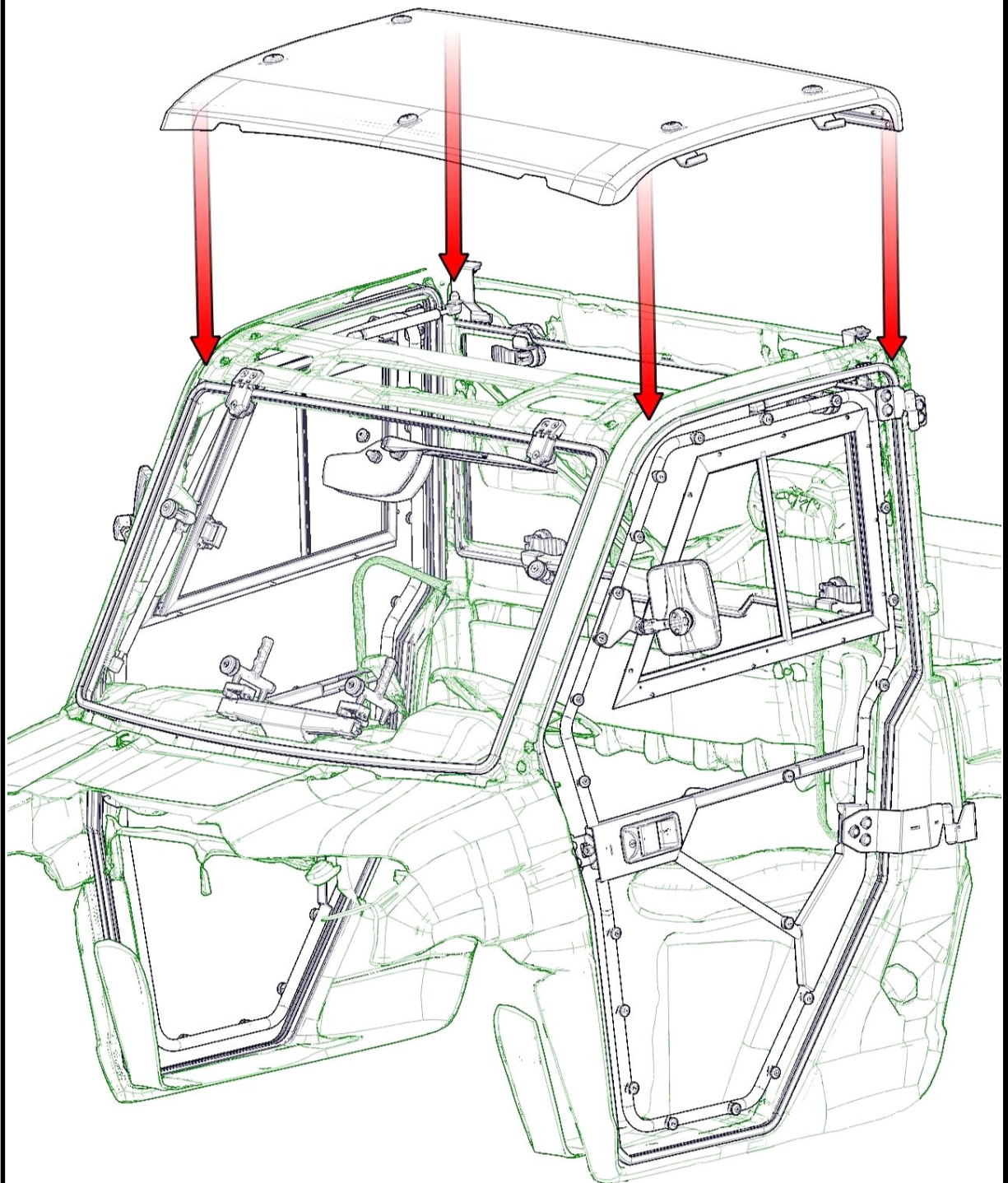

68

Adjust the roof panel to the best position. Press the roof panel against the UTV roll cage. The roof panel the seal must be attached to the frame.

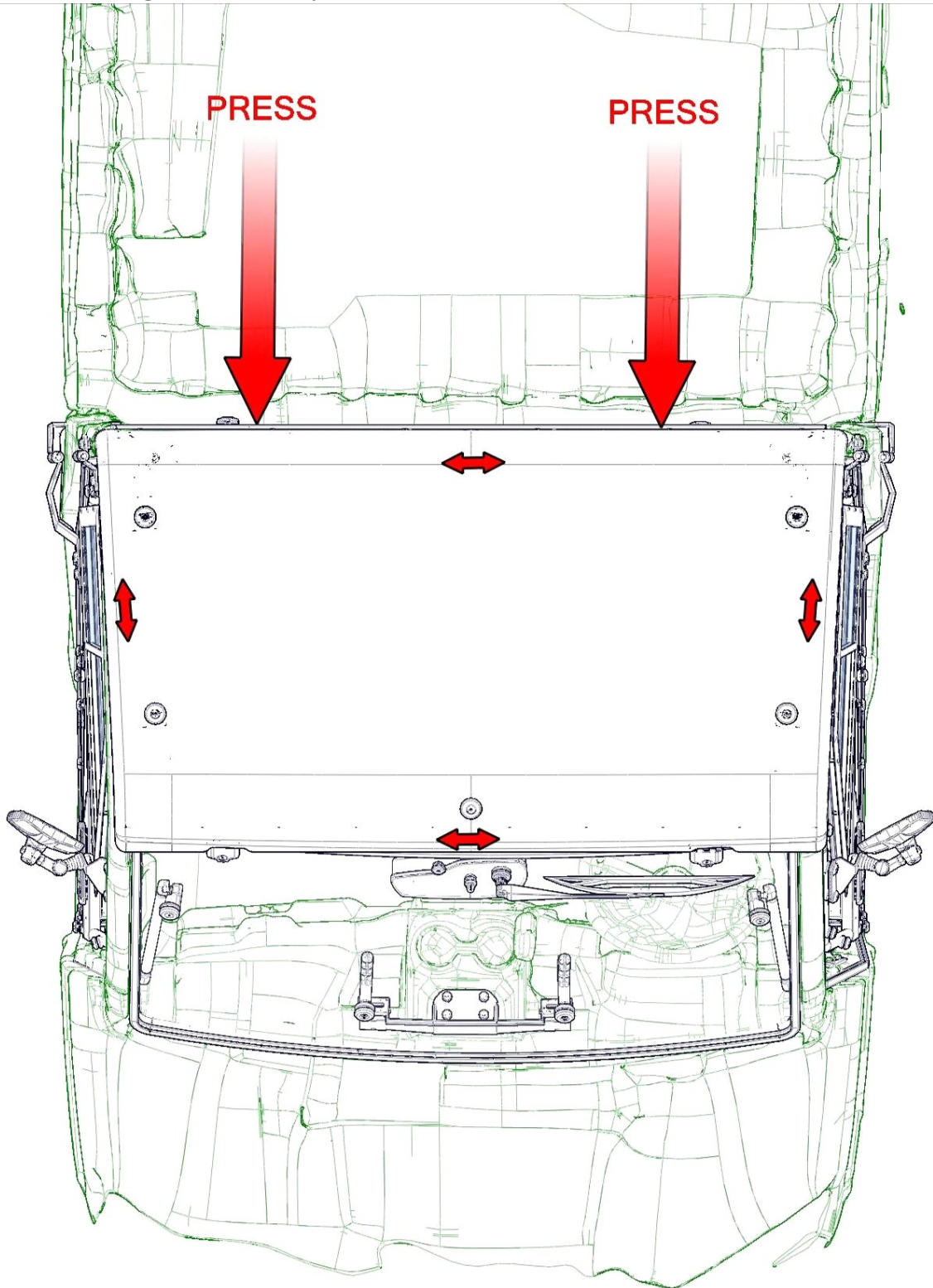

Turn the roof panel holders to the correct position and tighten the clamping levers.



70

BOLT TORQUE

BOLT TORQUE SPECIFICATIONS

GENERAL TORQUE SPECIFICATION TABLE

Use the following torques when special torques are not given. These values apply to fasteners as received from suppliers, dry, or when lubricated with normal engine oil. They do not apply if special graphited or moly disulphide greases or other extreme pressure lubricants are used. This applies to both UNF and UNC threads. Remember to always use grade five or better when replacing bolts.

IMPORTANT: On all PLATED GRADE 8 bolts, reduce torque 15% from listed bolt torque specification.

SAE Grade No.		2				5				8*			
Bolt head identification mark as per grade. NOTE: Manufacturing Marks Will Vary													
Bolt Size		TORQUE				TORQUE				TORQUE			
		Pounds Feet		Newton-Meters		Pounds Feet		Newton-Meters		Pounds Feet		Newton-Meters	
Inches	Millimeters	Min.	Max.	Min.	Max.	Min.	Max.	Min.	Max.	Min.	Max.	Min.	Max.
1/4	6.35	5	6	7	8	9	11	12	15	12	15	16	20
5/16	7.94	10	12	14	16	17	20.5	23	28	24	29	33	39
3/8	9.53	20	23	27	31	35	42	48	57	45	54	61	73
7/16	11.11	30	35	41	47	54	64	73	87	70	84	95	114
1/2	12.70	45	52	61	70	80	96	109	130	110	132	149	179
9/16	14.29	65	75	88	102	110	132	149	179	160	192	217	260
5/8	15.88	95	105	129	142	150	180	203	244	220	264	298	358
3/4	19.05	150	185	203	251	270	324	366	439	380	456	515	618
7/8	22.23	160	200	217	271	400	480	542	651	600	720	814	976
1	25.40	250	300	339	406	580	696	787	944	900	1080	1220	1464
1-1/8	25.58	-	-	-	-	800	880	1085	1193	1280	1440	1736	1953
1-1/4	31.75	-	-	-	-	1120	1240	1519	1681	1820	2000	2468	2712
1-3/8	34.93	-	-	-	-	1460	1680	1980	2278	2380	2720	3227	3688
1-1/2	38.10	-	-	-	-	1940	2200	2631	2983	3160	3560	4285	4827

*Thick Nuts must be used with Grade 8 bolts

71

METRIC BOLT TORQUE SPECIFICATIONS



Size of Screw	Property Class	Course Thread			Fine Thread		
		Pitch (mm)	Pounds Feet	Newton-Meters	Pitch (mm)	Pounds Feet	Newton-Meters
M6	5.6	1.0	3.6-5.8	4.9-7.9	-	-	-
	8.8		5.8-9.4	7.9-12.7		-	-
	10.9		7.2-10	9.8-13.6		-	-
M8	5.6	1.25	7.2-14	9.8-19	1.0	12-17	16.3-23
	8.8		17-22	23-29.8		19-27	25.7-36.6
	10.9		20-26	27.1-35.2		22-31	29.8-42
M10	5.6	1.5	20-25	27.1-33.9	1.25	20-29	27.1-39.3
	8.8		34-40	46.1-54.2		35-47	47.4-63.7
	10.9		38-46	51.5-62.3		40-52	54.2-70.5
M12	5.6	1.75	28-34	37.9-46.1	1.25	31-41	42-55.6
	8.8		51-59	69.1-79.9		55-68	75.9-92.1
	10.9		57-66	77.2-89.4		62-75	84-101.6
M14	5.6	2.0	49-56	66.4-75.9	1.5	52-64	70.5-86.7
	8.8		81-93	109.8-126		90-106	122-143.6
	10.9		96-109	130.1-147.7		107-124	145-168
M16	5.6	2.0	67-77	90.8-104.3	1.5	69-83	93.6-112.5
	8.8		116-130	157.2-176.2		120-138	162.6-187
	10.9		129-145	174.8-196.5		140-158	189.7-214.1
M18	5.6	2.0	88-100	119.2-136	1.5	100-117	136-158.5
	8.8		150-168	203.3-227.6		177-199	239.8-269.6
	10.9		175-194	237.1-262.9		202-231	273.7-313
M20	5.6	2.5	108-130	146.3-176.2	1.5	132-150	178.9-203.3
	8.8		186-205	252-277.8		206-242	279.1-327.9
	10.9		213-249	288.6-337.4		246-289	333.3-391.6

