



SPARE - PARTS CATALOG

POLARIS
RANGER 900 XP CREW



CAB PREVIEW

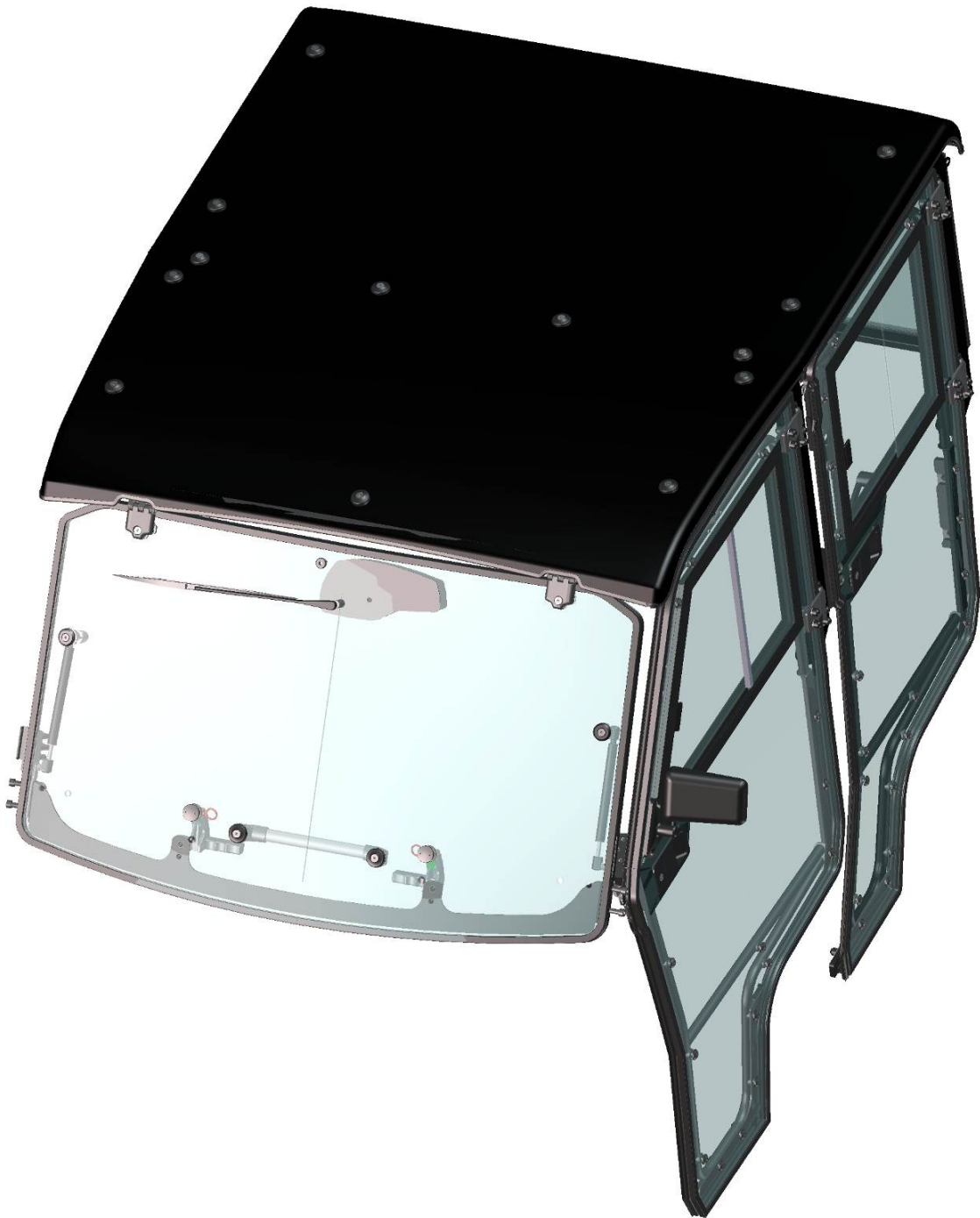

2

FOR ALL TECHNICAL QUESTIONS, PLEASE CALL
DFK AMERICA INC.
(630) 324-8585

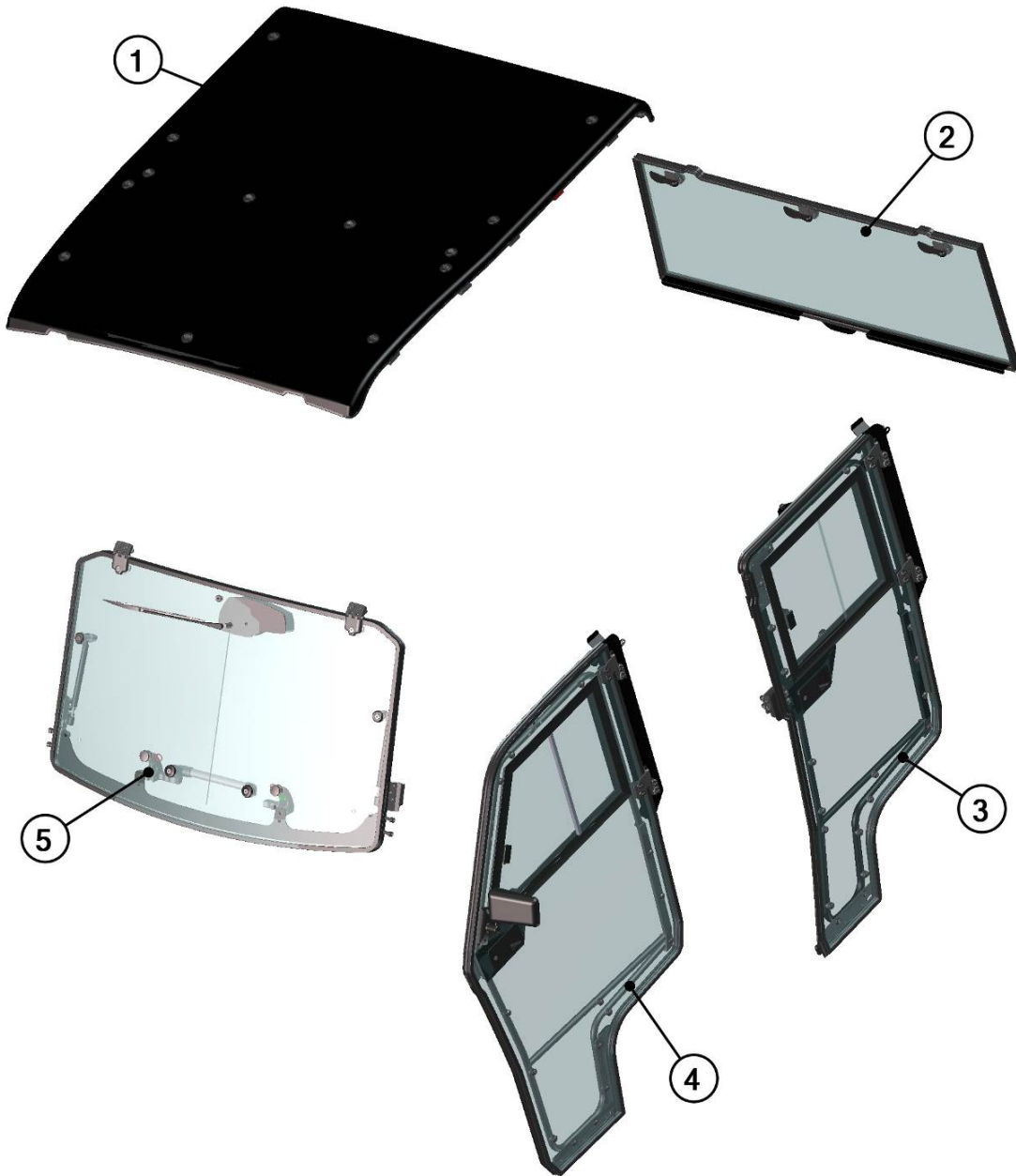

3

Position	Catalogue no.	Description	Qty
1	32S06U01S30	ROOF	1
2	32S05U01S20	REAR PANEL	1
3	32S06U01S40	LEFT REAR DOOR	1
4	32S05U01S40	LEFT FRONT DOOR	1
5	32S05U01S10	FRONT PANEL MOVABLE	1
6	32S06U01S50	RIGHT REAR DOOR	1
7	32S05U01S50	RIGHT FRONT DOOR	1

FOR ALL TECHNICAL QUESTIONS, PLEASE CALL
 DFK AMERICA INC.
 (630) 324-8585

FRONT PANEL





5

Position	Catalogue no.	Description	Qty
1	*****	FRONT UPPER ASSEMBLY	1
2	*****	FRONT BOTTOM ASSEMBLY	1

FOR ALL TECHNICAL QUESTIONS, PLEASE CALL
 DFK AMERICA INC.
 (630) 324-8585

FRONT UPPER ASSEMBLY



6

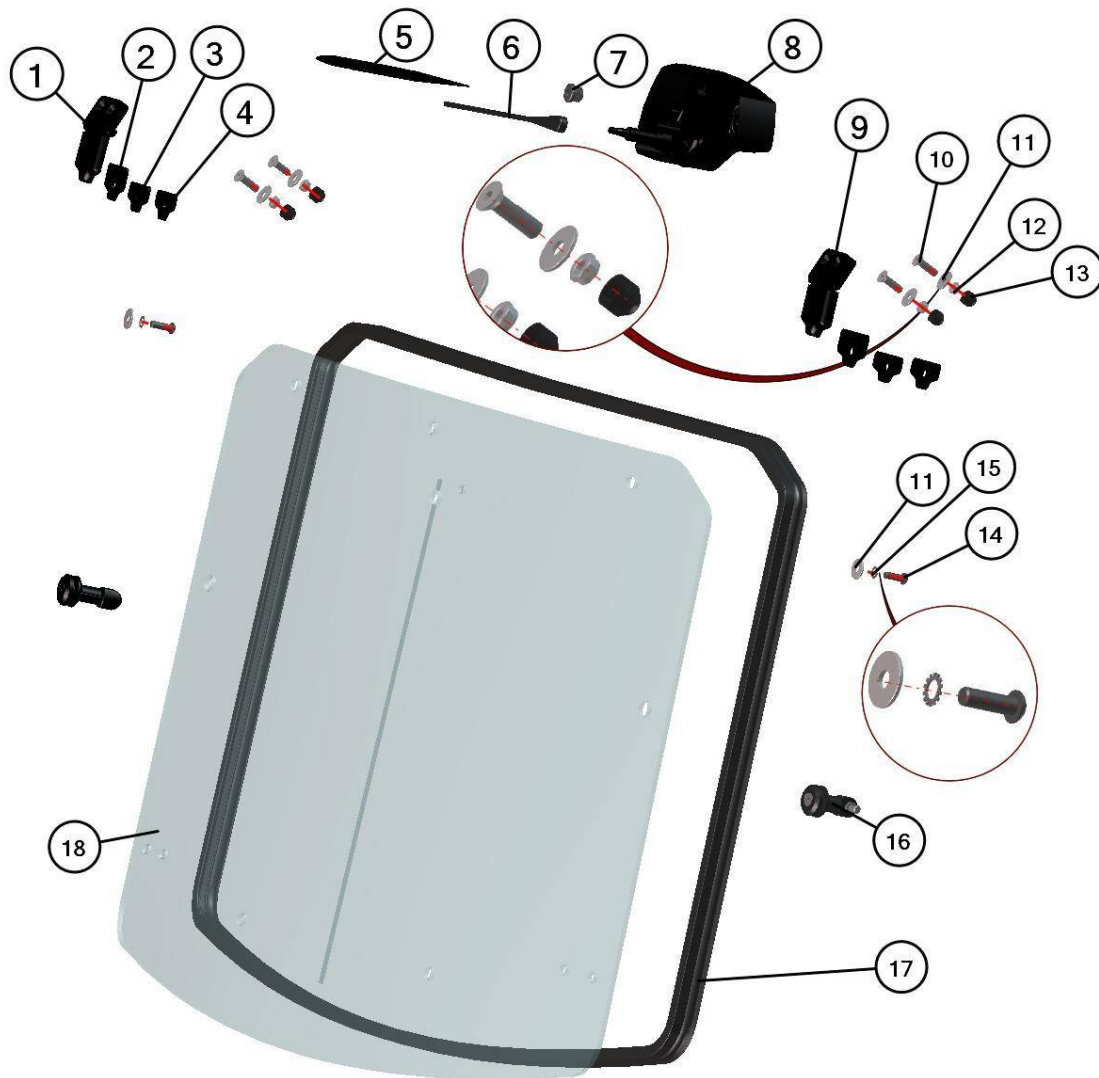

Position	Catalogue no.	Description	Qty
1	002719	FRONT HINGE RIGHT	1
2	32S05U01-10-017	FRONT HINGE SEAL OUTER	2
3	32S05U01-10-018	FRONT HINGE SEAL INNER	2
4	32S05U01-10-019	FRONT HINGE LEDGE	2
5	002554	WIPER LATCH	1
6	002535	WIPER ARM	1
7	00-01-005	BUSHING	1
8	002764	WIPER MOTOR 12V	1
9	002717	FRONT HINGE LEFT	1
10	002121	SCREW M8x30	4
11	001407	WASHER 8 LARGE	6
12	001388	SELF-LOCKING NUT M8	4
13	001309	PLASTIC NUT COVER OK 13	4
14	002746	SCREW M8x25	2
15	001489	SERRATED-LOCK WASHER 8	2
16	001693	GAS SPRING HOLDER	2
17	001012^32S05U01-10M001	RUBBER PROFILE "PIRELA GLASS"	1
18	32S05U01-10-001	FRONT GLASS	1

FOR ALL TECHNICAL QUESTIONS, PLEASE CALL

DFK AMERICA INC.

(630) 324-8585

FRONT BOTTOM ASSEMBLY



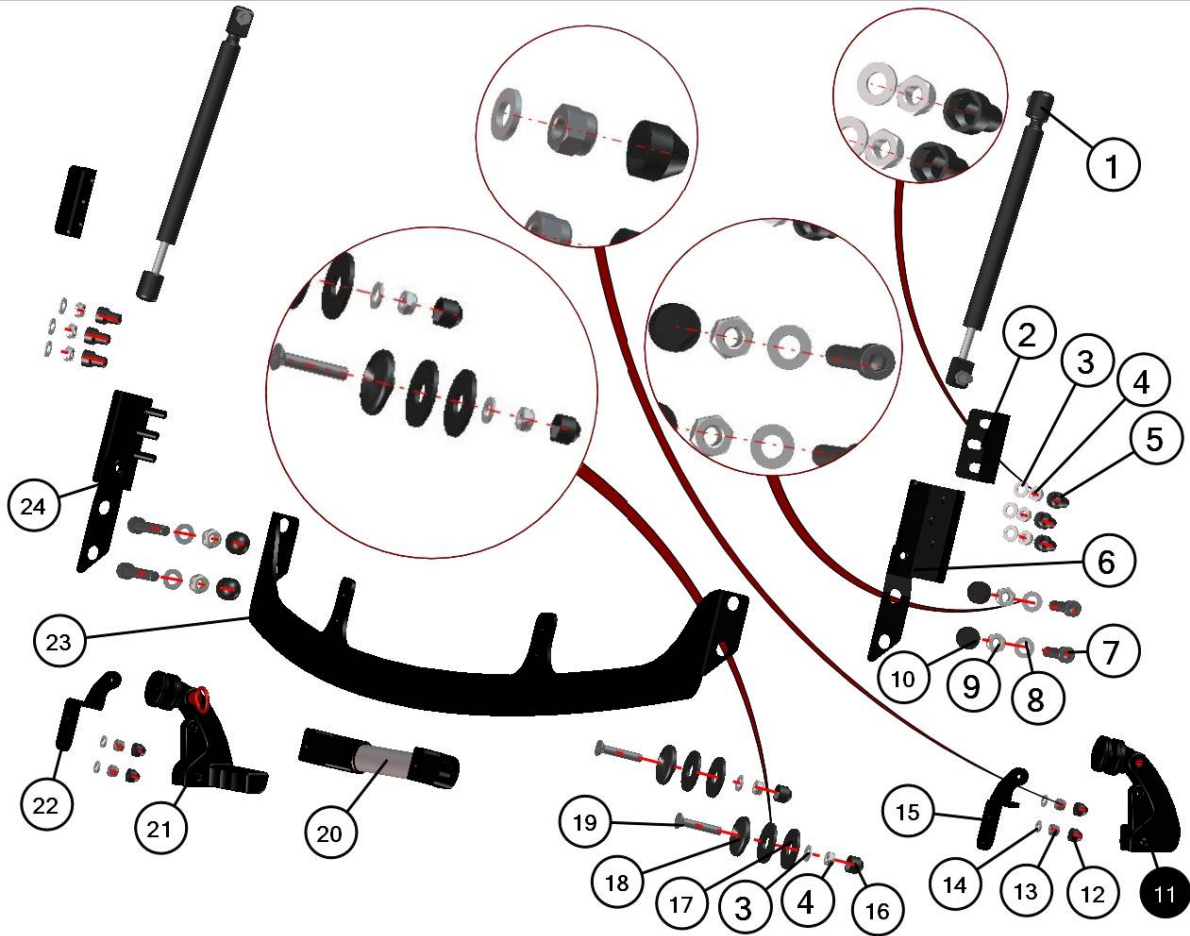

9

Position	Catalogue no.	Description	Qty
1	000868	GAS SPRING	2
2	32S05U01-10-003	FRONT OUTER HOLDER	2
3	001387	WASHER 8	8
4	001388	SELF-LOCKING NUT M8	8
5	001308	PLASTIC NUT COVER OK 13 LONG	6
6	32S05U01-10W003	LEFT FRONT HOLDER	1
7	002741	SCREW M10x60	4
8	001485	WASHER 10	4
9	002533	SELF-LOCKING NUT M8	4
10	002363	PLASTIC NUT COVER OK 17	4
11	002640	LEFT GLASS HANDLE MOVABLE	1
12	001348	PLASTIC NUT COVER OK 10	4
13	001392	SELF-LOCKING NUT M6	4
14	001426	WASHER 6	4
15	32S05U01-10-014	LEFT HANDLE HOLDER	1
16	001309	PLASTIC NUT COVER OK 13	2
17	001428	RUBBER WASHER 8	4
18	001429	PLASTIC WASHER 8	2
19	001694	SCREW M8x45	2
20	002709	FRONT HANDLE	1
21	002641	RIGHT GLASS HANDLE MOVABLE	1
22	32S05U01-10-022	RIGHT HANDLE HOLDER	1
23	32S05U01-10-013	FRONT BOTTOM LEDGE	1
24	32S05U01-10W007	RIGHT FRONT HOLDER	1

FOR ALL TECHNICAL QUESTIONS, PLEASE CALL

DFK AMERICA INC.

(630) 324-8585

REAR PANEL



10

FOR ALL TECHNICAL QUESTIONS, PLEASE CALL
DFK AMERICA INC.
(630) 324-8585

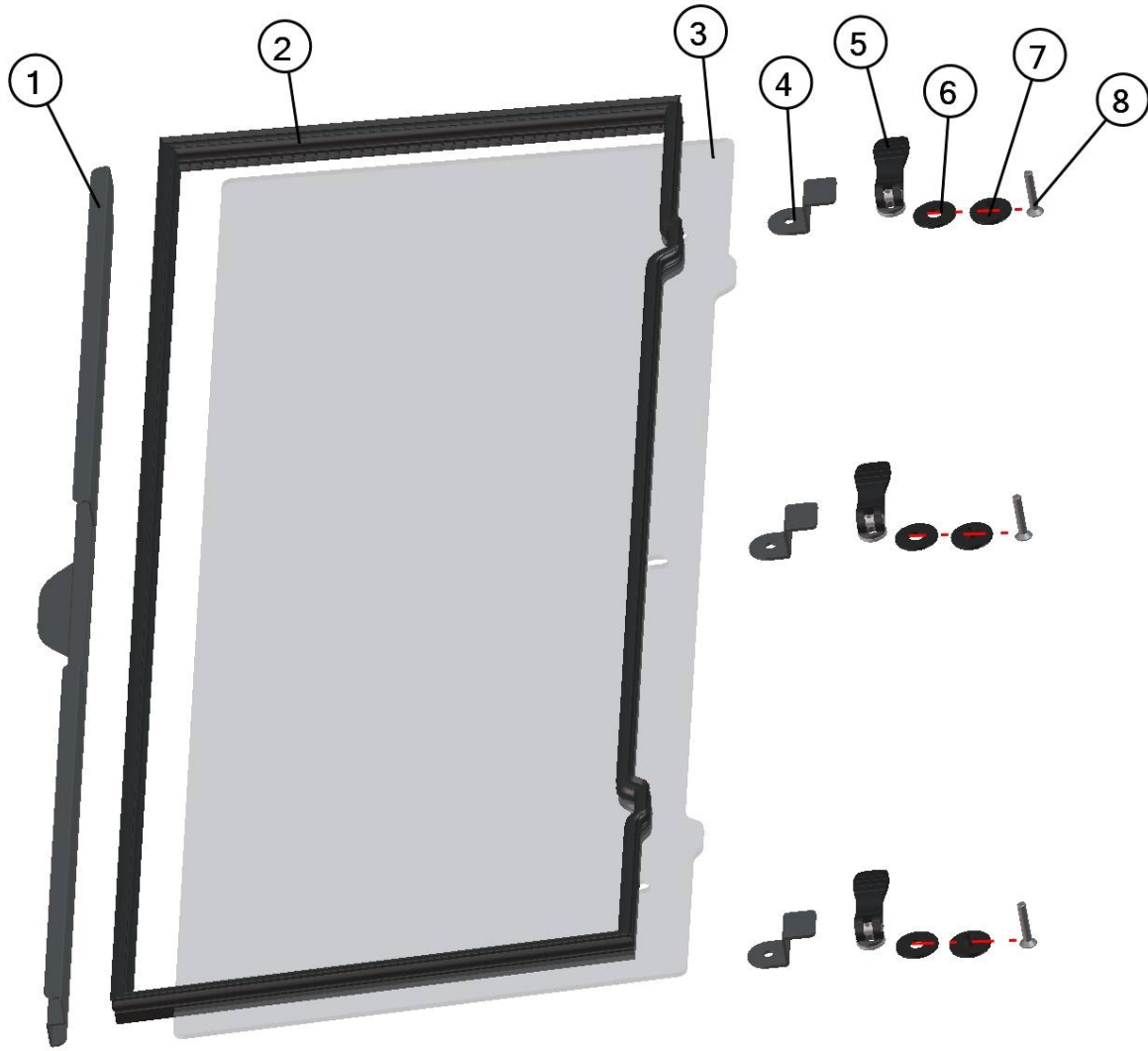

11

Position	Catalogue no.	Description	Qty
1	32S05U01-20W001	REAR BOTTOM LEDGE	1
2	001012^32S05U01-20M001	RUBBER PROFILE "PIRELA GLASS"	1
3	32S05U01-20-009	REAR GLASS	1
4	32S05U01-20-008	REAR HOLDER	3
5	002740	FAST LOCK HANDLE	3
6	001428	RUBBER WASHER 8	3
7	001429	PLASTIC WASHER 8	3
8	001694	SCREW M8x45	3

FOR ALL TECHNICAL QUESTIONS, PLEASE CALL
 DFK AMERICA INC.
 (630) 324-8585

ROOF



12

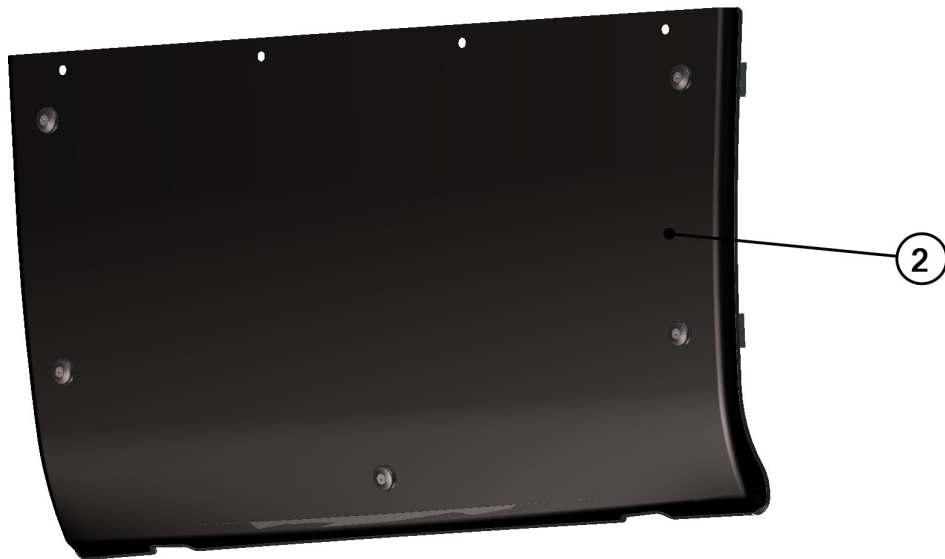
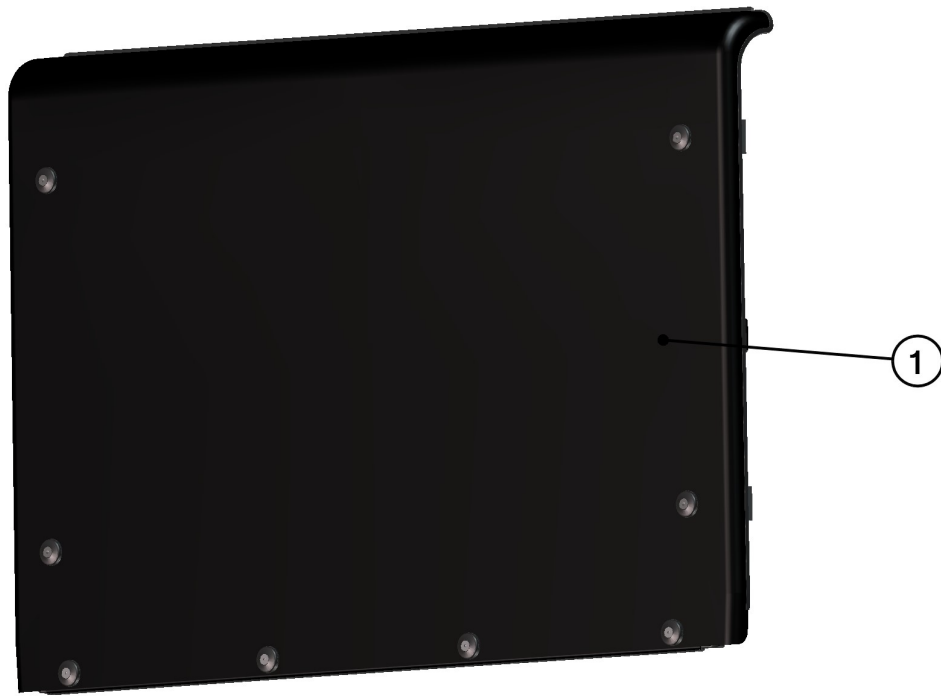

13

Position	Catalogue no.	Description	Qty
1	32S06U01-30M002	REAR ROOF ASSEMBLY	1
2	32S06U01-30M001	FRONT ROOF ASSEMBLY	1

ROOF



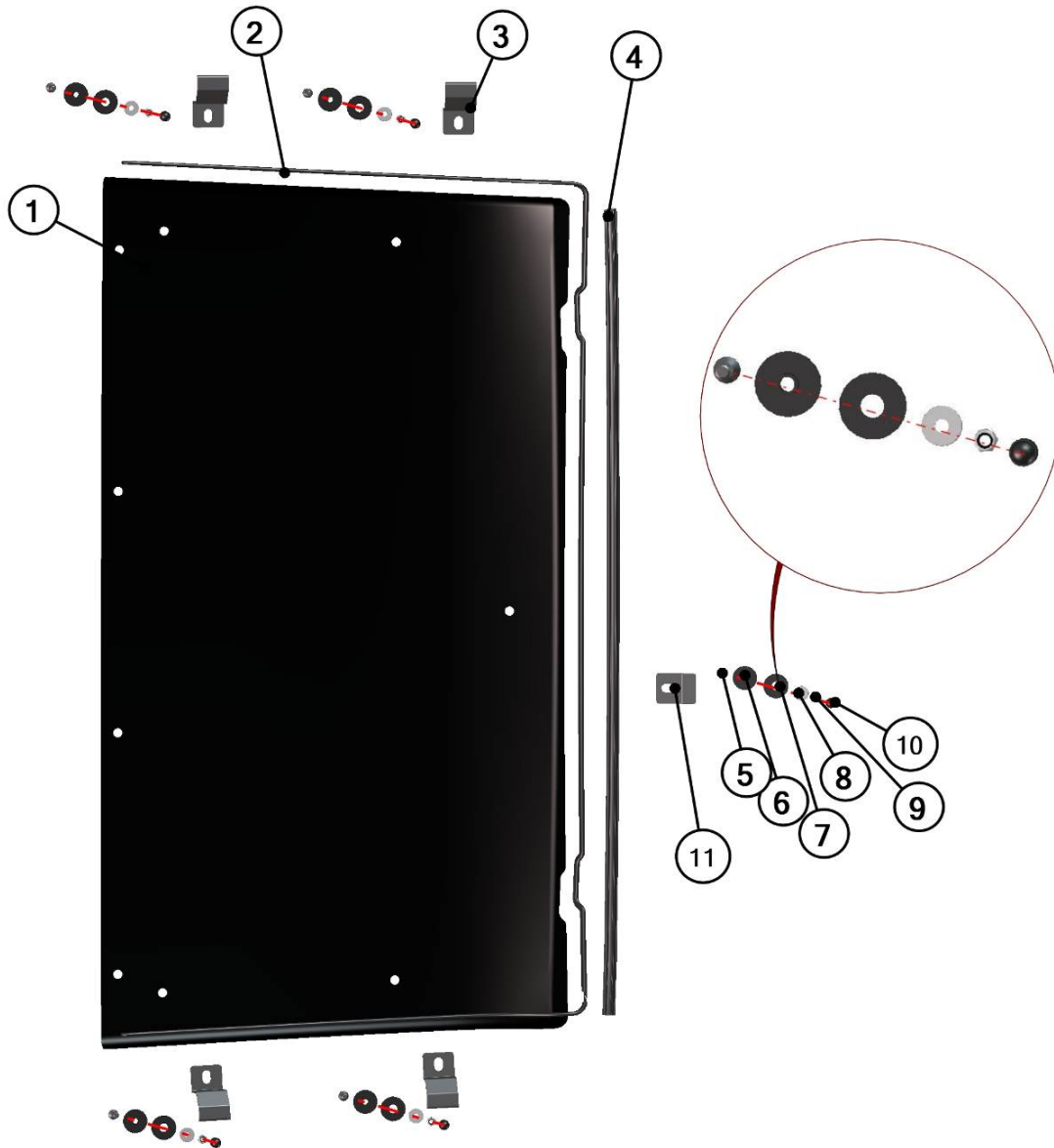

15

Position	Catalogue no.	Description	Qty
1	32S06U01-30-001	FRONT ROOF PANEL	1
2	001001^32S06U01-30M001	RUBBER PROFILE "LEMOVKA"	1
3	32S05U01-30-003	ROOF SIDE HOLDER	4
4	001010^32S06U01-30M001	RUBBER PROFILE "SARAZIN"	1
5	002121	SCREW M8x30	5
6	001429	PLASTIC WASHER 8	5
7	001428	RUBBER WASHER 8	5
8	001407	WASHER 8 LARGE	5
9	001388	SELF-LOCKING M8	5
10	001309	PLASTIC NUT COVER OK 13	5
11	32S05U01-30-005	ROOF FRONT HOLDER	1

FOR ALL TECHNICAL QUESTIONS, PLEASE CALL
 DFK AMERICA INC.
 (630) 324-8585

ROOF

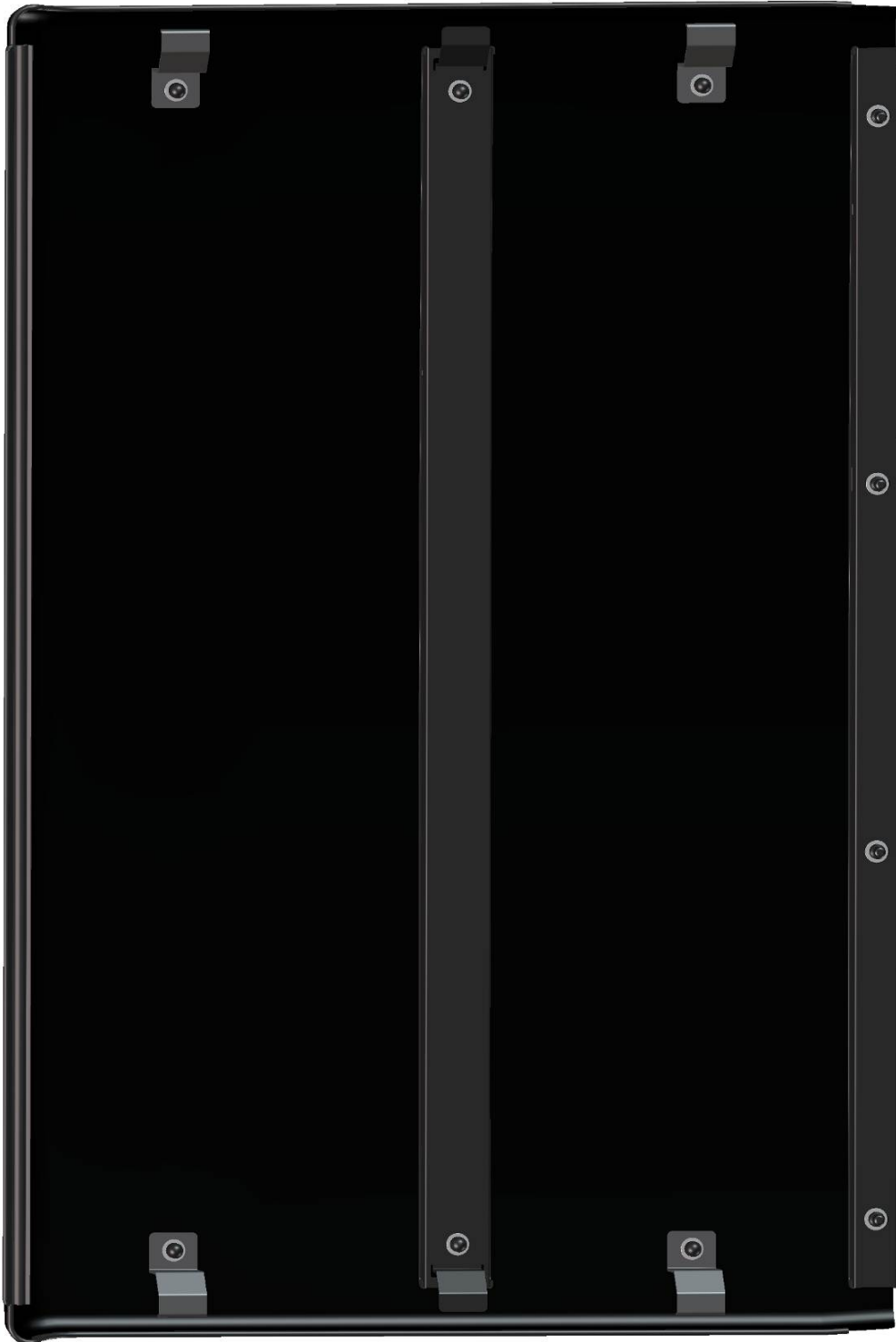

16

FOR ALL TECHNICAL QUESTIONS, PLEASE CALL
DFK AMERICA INC.
(630) 324-8585

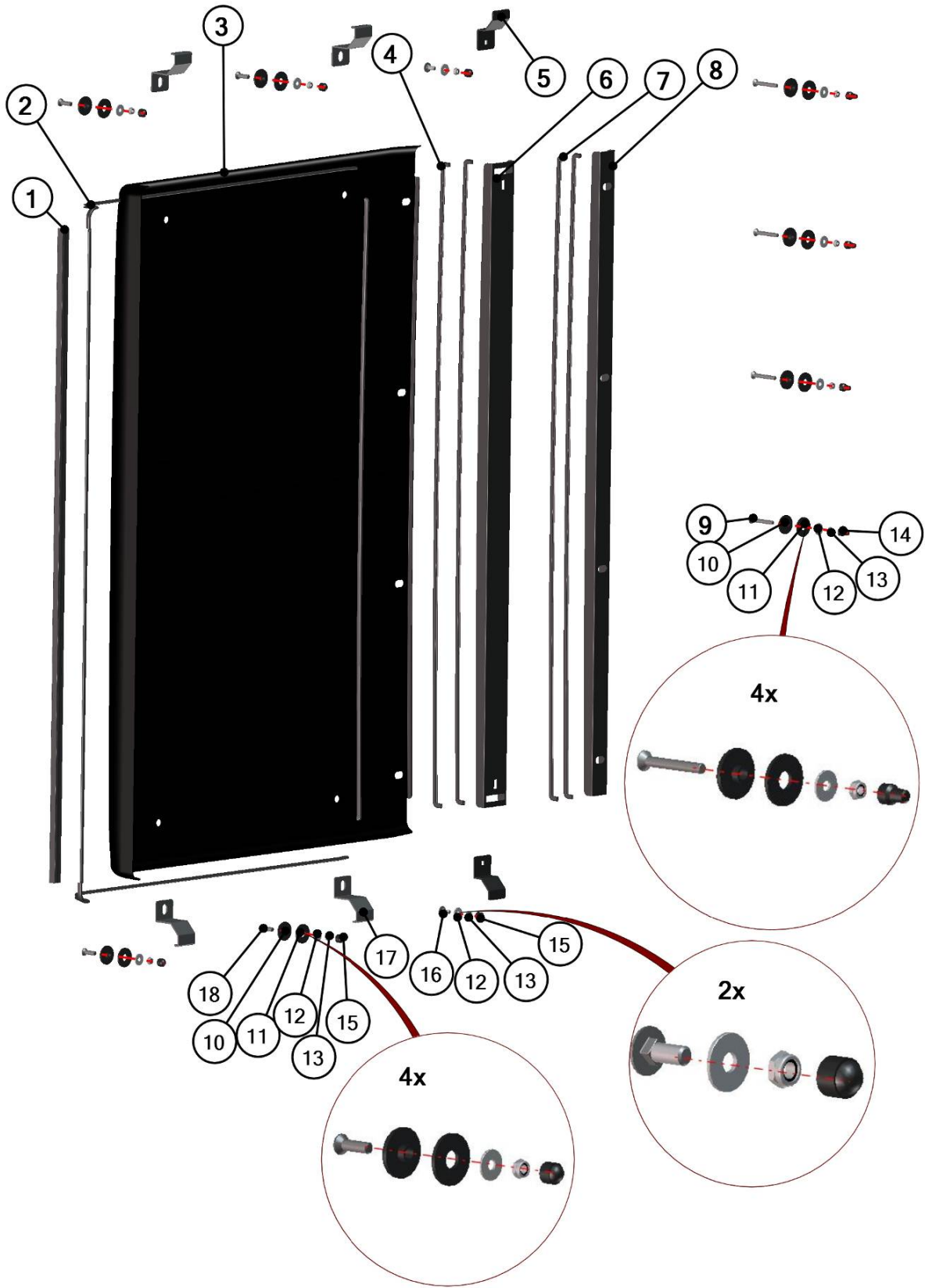



Position	Catalogue no.	Description	Qty
1	001010^32S06U01-30M002	RUBBER PROFILE "SARAZIN"	1
2	001001^32S06U01-30M002	RUBBER PROFILE "LEMOVKA"	1
3	32S06U01-30-002	ROOF PANEL REAR	1
4	001001^32S06U01-30M004	RUBBER PROFILE "LEMOVKA"	1
5	32S06U01-30-006	ROOF REAR REINFORCEMENT HOLDER	2
6	32S06U01-30-007	ROOF REAR REINFORCEMENT	1
7	001001^32S06U01-30M005	RUBBER PROFILE "LEMOVKA"	1
8	32S06U01-30-008	ROOF CENTRAL REINFORCEMENT	1
9	001399	SCREW M8x60	4
10	001429	PLASTIC WASHER 8	8
11	001428	RUBBER WASHER 8	8
12	001407	WASHER 8 LARGE	10
13	001388	SELF-LOCKING NUT M8	10
14	001308	PLASTIC NUT COVER OK13 LONG	4
15	001309	PLASTIC NUT COVER OK13	6
16	002575	SCREW M8x25	2
17	32S05U01-30-003	ROOF SIDE HOLDER	4
18	002121	SCREW M8x30	4

FRONT LEFT DOOR+FRONT RIGHT DOOR

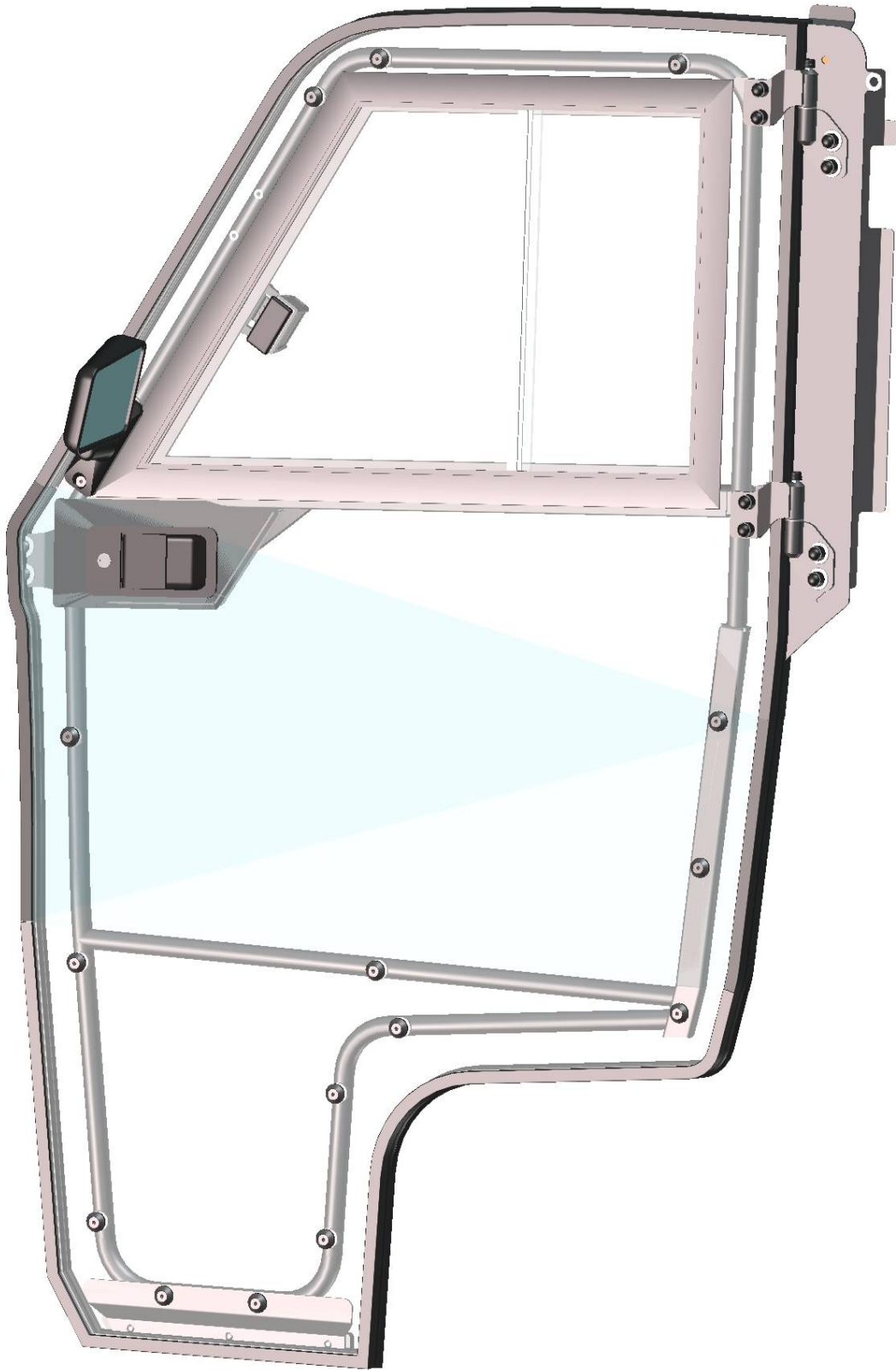

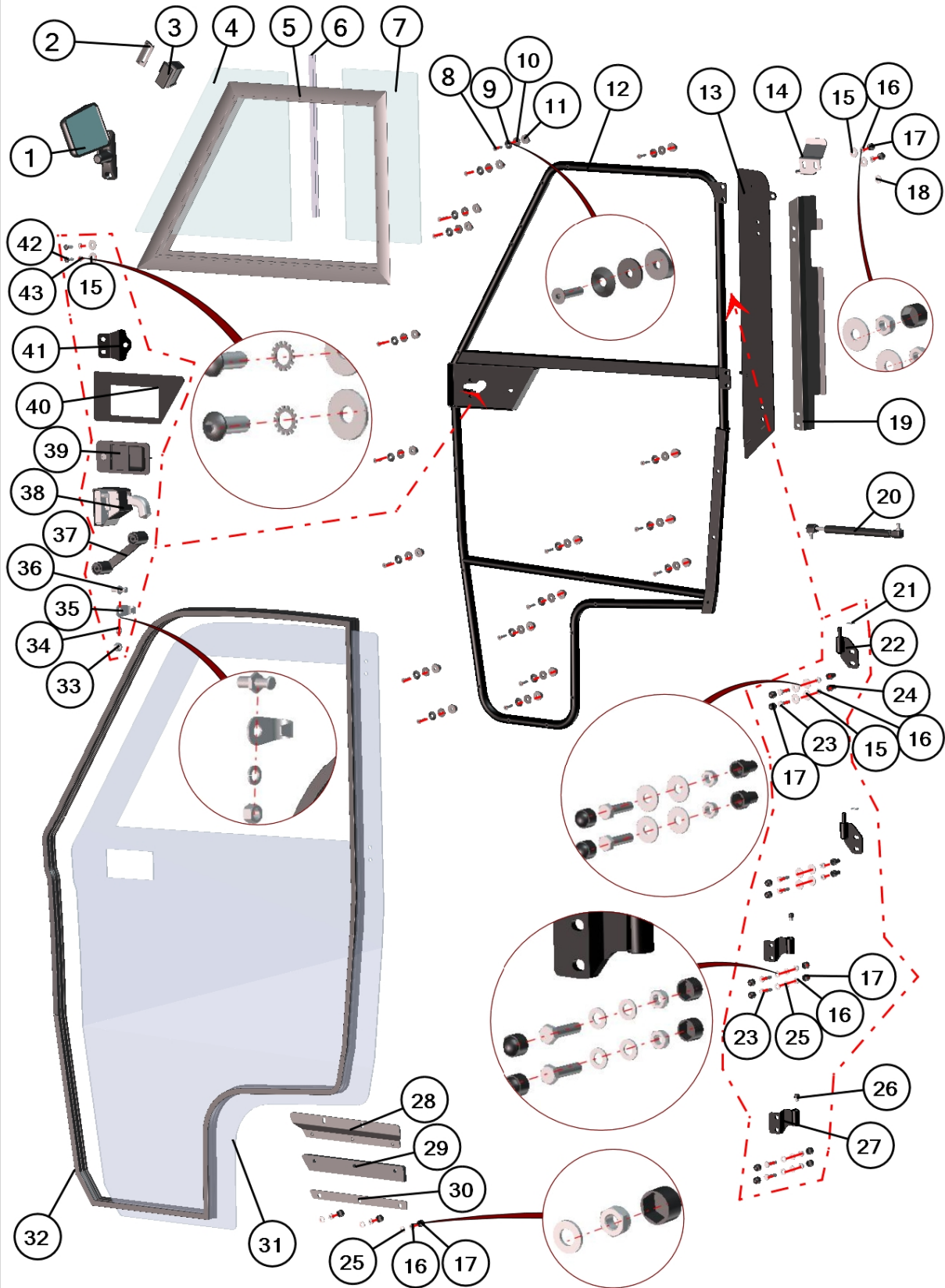

FOR ALL TECHNICAL QUESTIONS, PLEASE CALL
DFK AMERICA INC.
(630) 324-8585



LEFT DOOR TABLE

Position	Catalogue no.	Description	Qty
1	002773	LEFT REAR MIRROR	1
2	001762	GLASS STOP	1
3	001700	GLASS LOCK	1
4	32S05U01-40-009	DOOR WINDOW MOVABLE GLASS	1
5	32S05U01-40-006	LEFT WINDOW FRAME PVC	1
6	32S05U01-40-010	WINDOW AL PROFILE "U"	1
7	32S05U01-40-008	DOOR WINDOW SOLID POLYCARBONATE	1
8	002120	SCREW M6x25	18
9	001715	PLASTIC WASHER 6	18
10	001735	RUBBER WASHER 6	18
11	001736	SEAT WASHER 6	18
12	32S05U01-40W002	LEFT DOOR FRAME WELDED	1
13	32S05U01-40W001	LEFT DOOR BASE WELDED	1
14	32S05U01-40PK001	LEFT DOOR BASE HOLDER	1
15	001407	WASHER 8 LARGE	12
16	001388	SELF-LOCKING NUT M8	13
17	001309	PLASTIC NUT COVER OK 13	17
18	001485	WASHER 8	1
19	32S05U01-40-003	LEFT DOOR BASE LEDGE	1
20	000865	GAS SPRING	1
21	001485	WASHER 10	2
22	32S05U01-40W005	LEFT DOOR HINGE BASE	2
23	001411	SCREW M8x30	8
24	001308	PLASTIC NUT COVER OK 13 LONG	4
25	001387	WASHER 8	11
26	001430	HINGE LUBRICATOR	2
27	32S05U01-40W003	LEFT DOOR HINGE	2
28	32S05U01-40W004	LEFT BOTTOM LEDGE WELDED	1
29	32S05U01-40-023	BOTTOM LEDGE EPDM	1
30	32S05U01-40-024	BOTTOM LEDGE METAL	1
31	32S05U01-40-005	LEFT DOOR PANEL POLYCARBONATE	1
32	002454^32S05U01S40	RUBBER PROFILE "SARAZIN SIDE"	1
33	000856	DOOR STOP NUT	1
34	000857	DOOR STOP WASHER	1
35	000855	DOOR STOP HOOK	1
36	000854	DOOR STOP PIN	1
37	001703	HANDLE	1
38	001743	LEFT INNER DOOR LOCK	1
39	000841	OUTER DOOR LOCK	1
40	32S05U01-40-016	DOOR LOCK LEDGE	1
41	32S05U01-40-019	LEFT DOOR STOP HOLDER	1
42	002745	SCREW M8x20	2
43	001489	SERRATED-LOCK WASHER 8	2

RIGHT DOOR TABLE

Position	Catalogue no.	Description	Qty
1	002774	RIGHT REAR MIRROR	1
2	001762	GLASS STOP	1
3	001700	GLASS LOCK	1
4	32S05U01-40-009	DOOR WINDOW MOVABLE GLASS	1
5	32S05U01-50-006	RIGHT WINDOW FRAME PVC	1
6	32S05U01-40-010	WINDOW AL PROFILE "U"	1
7	32S05U01-40-008	DOOR WINDOW SOLID POLYCARBONATE	1
8	002120	SCREW M6x25	18
9	001715	PLASTIC WASHER 6	18
10	001735	RUBBER WASHER 6	18
11	001736	SEAT WASHER 6	18
12	32S05U01-50W002	RIGHT DOOR FRAME WELDED	1
13	32S05U01-50W001	RIGHT DOOR BASE WELDED	1
14	32S05U01-50PK001	RIGHT DOOR BASE HOLDER	1
15	001407	WASHER 8 LARGE	12
16	001388	SELF-LOCKING NUT M8	13
17	001309	PLASTIC NUT COVER OK 13	17
18	001485	WASHER 8	1
19	32S05U01-50-003	RIGHT DOOR BASE LEDGE	1
20	000865	GAS SPRING	1
21	001485	WASHER 10	2
22	32S05U01-50W005	RIGHT DOOR HINGE BASE	2
23	001411	SCREW M8x30	8
24	001308	PLASTIC NUT COVER OK 13 LONG	4
25	001387	WASHER 8	11
26	001430	HINGE LUBRICATOR	2
27	32S05U01-50W003	RIGHT DOOR HINGE	2
28	32S05U01-50W004	RIGHT BOTTOM LEDGE WELDED	1
29	32S05U01-40-023	BOTTOM LEDGE EPDM	1
30	32S05U01-40-024	BOTTOM LEDGE METAL	1
31	32S05U01-50-005	RIGHT DOOR PANEL POLYCARBONATE	1
32	002454^32S05U01S40	RUBBER PROFILE "SARAZIN SIDE"	1
33	000856	DOOR STOP NUT	1
34	000857	DOOR STOP WASHER	1
35	000855	DOOR STOP HOOK	1
36	000854	DOOR STOP PIN	1
37	001703	HANDLE	1
38	001744	RIGHT INNER DOOR LOCK	1
39	000841	OUTER DOOR LOCK	1
40	32S05U01-40-016	DOOR LOCK LEDGE	1
41	32S05U01-50-019	RIGHT DOOR STOP HOLDER	1
42	002745	SCREW M8x20	2
43	001489	SERRATED-LOCK WASHER 8	2

REAR LEFT DOOR+REAR RIGHT DOOR

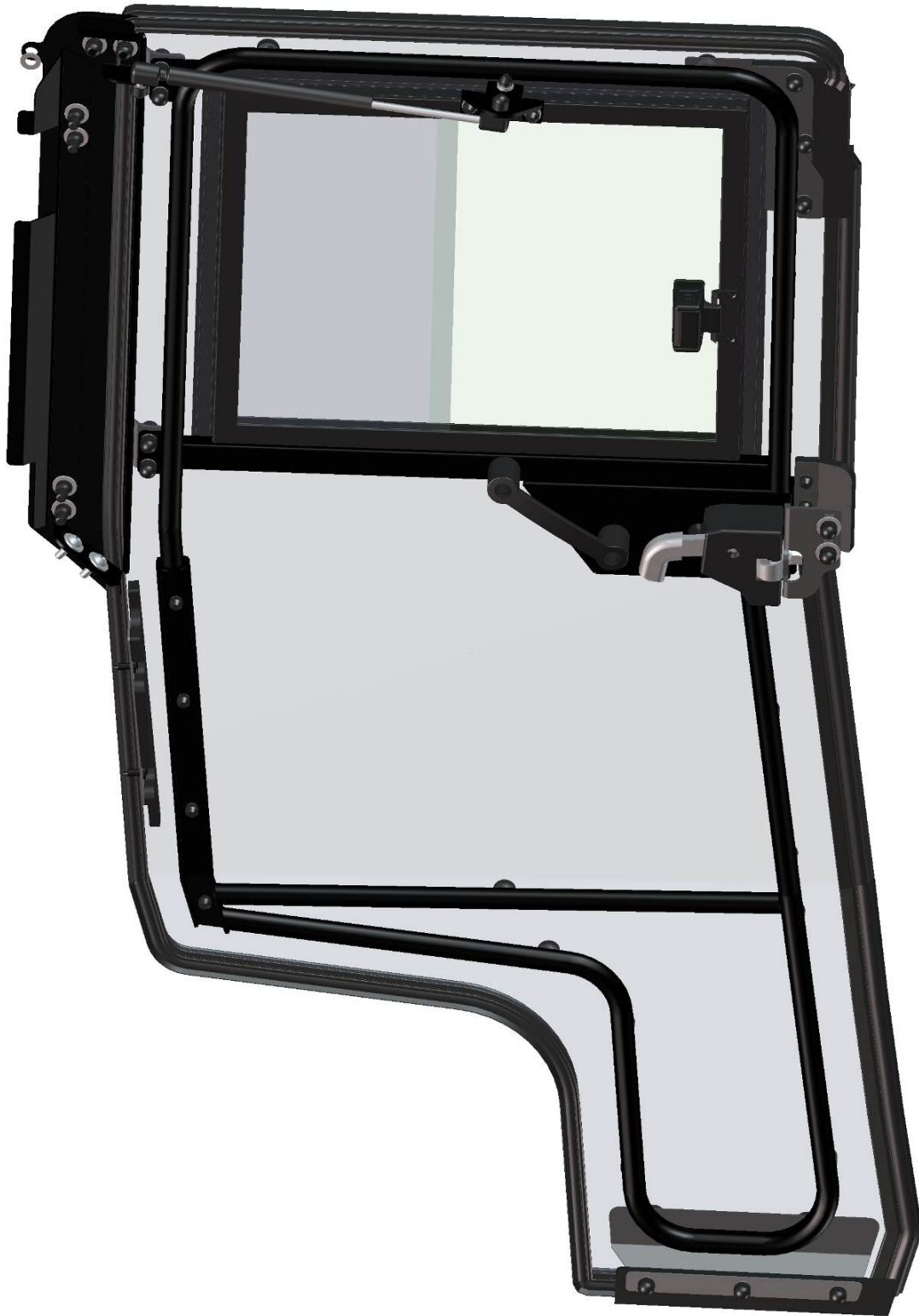



Position	Catalogue no.	Description	Qty
1	*****	LEFT REAR DOOR BASE ASSEMBLY	1
2	*****	LEFT REAR DOOR ASSEMBLY	1

FOR ALL TECHNICAL QUESTIONS, PLEASE CALL
 DFK AMERICA INC.
 (630) 324-8585

REAR DOOR BASE ASSEMBLY



25

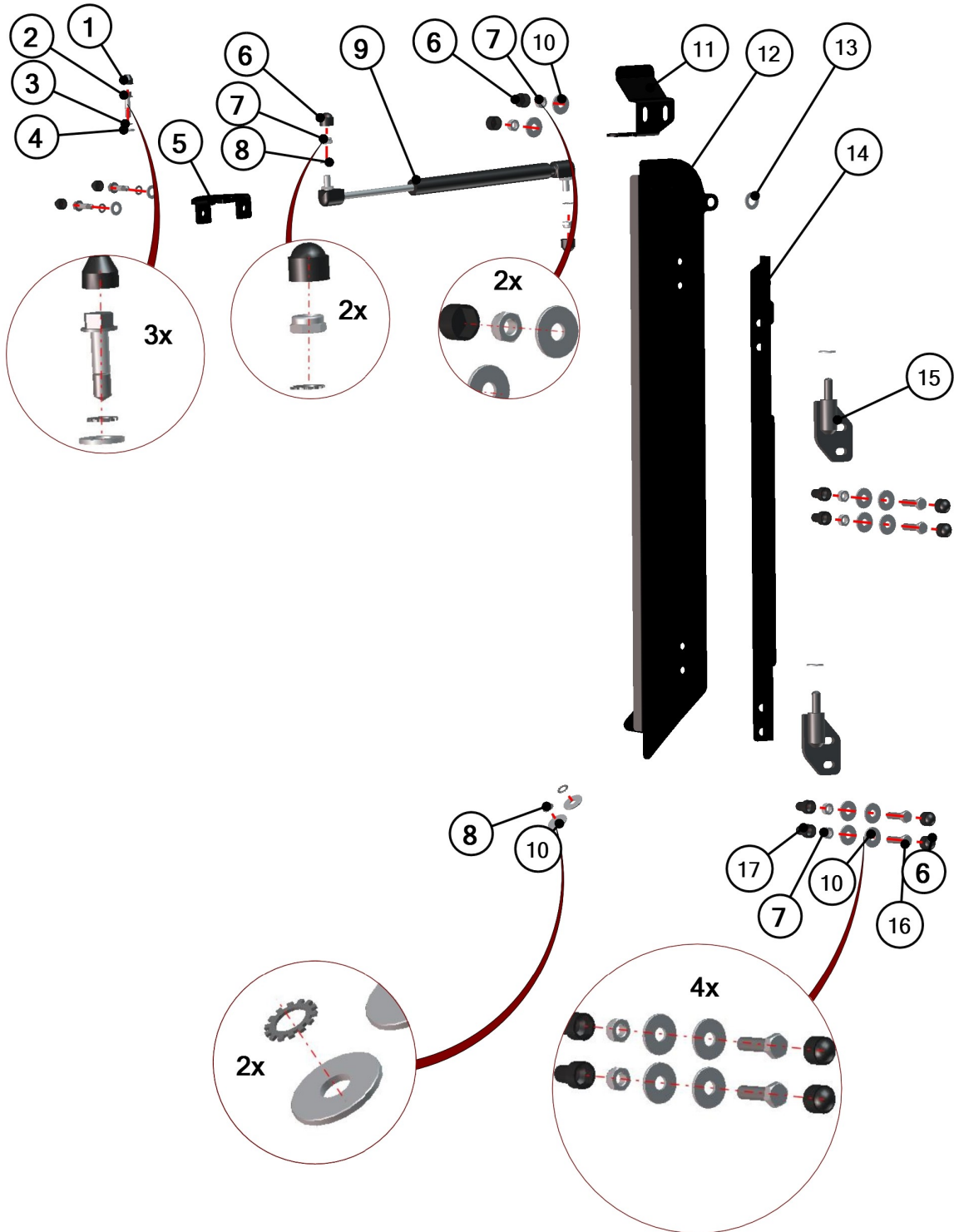

LEFT TABLE

Position	Catalogue no.	Description	Qty
1	001348	PLASTIC NUT COVER OK10	3
2	001459	TEX SCREW 6,3x25	3
3	001488	SERRATED-LOCK WASHER 6	3
4	001387	WASHER 6 LARGE	3
5	32S05U01-40PK-002	DOOR GAS SPRING HOLDER	1
6	001309	PLASTIC NUT COVER OK13	8
7	001388	SELF-LOCKING NUT M8	8
8	001489	SERRATED-LOCK WASHER 8	4
9	000865	GAS SPRING	1
10	001407	WASHER 8 LARGE	12
11	32S05U01-40PK-001	LEFT BASE GAS SPRING HOLDER	1
12	32S05U01-40W001	LEFT DOOR BASE	1
13	001485	WASHER 10	3
14	32S05U01-40-003	LEFT DOOR BASE LEDGE	1
15	32S05U01-40W005	LEFT BASE HINGE WELDED	2
16	001411	SCREW M8x30	4
17	001308	PLASTIC NUT COVER OK13 LONG	4

RIGHT TABLE

Position	Catalogue no.	Description	Qty
1	001348	PLASTIC NUT COVER OK10	3
2	001459	TEX SCREW 6,3x25	3
3	001488	SERRATED-LOCK WASHER 6	3
4	001387	WASHER 6 LARGE	3
5	32S05U01-40PK-002	DOOR GAS SPRING HOLDER	1
6	001309	PLASTIC NUT COVER OK13	8
7	001388	SELF-LOCKING NUT M8	8
8	001489	SERRATED-LOCK WASHER 8	4
9	000865	GAS SPRING	1
10	001407	WASHER 8 LARGE	12
11	32S05U01-50PK-001	RIGHT BASE GAS SPRING HOLDER	1
12	32S05U01-50W001	RIGHT DOOR BASE	1
13	001485	WASHER 10	3
14	32S05U01-50-003	RIGHT DOOR BASE LEDGE	1
15	32S05U01-50W005	RIGHT BASE HINGE WELDED	2
16	001411	SCREW M8x30	4
17	001308	PLASTIC NUT COVER OK13 LONG	4

REAR DOOR ASSEMBLY



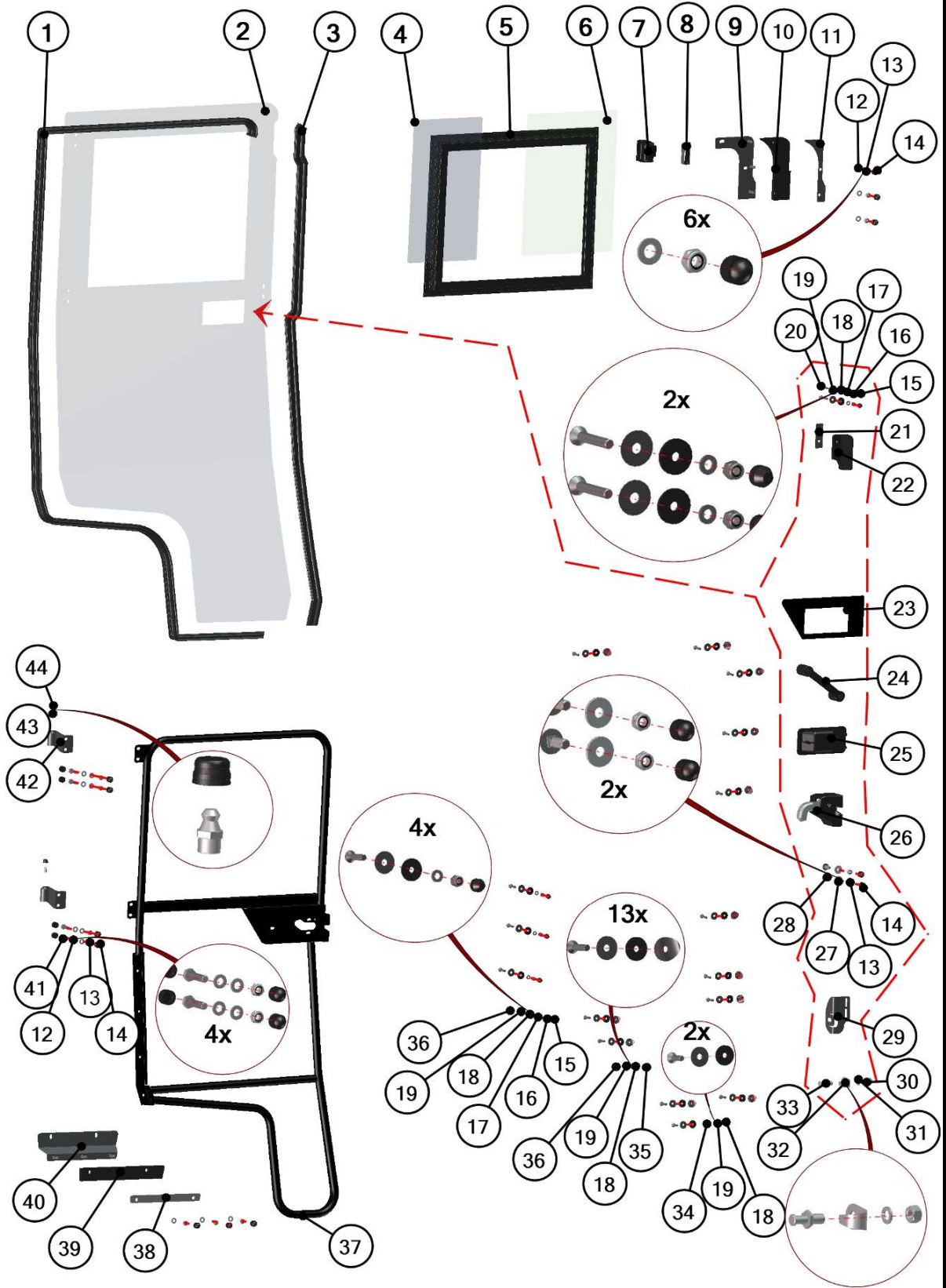

LEFT TABLE

Position	Catalogue no.	Description	Qty
1	32S06U01-40-035	RUBBER PROFILE "SARAZIN SIDE"	1
2	32S06U01-40-001	LEFT REAR DOOR PANEL POLY	1
3	32S06U01-40-036	RUBBER PROFILE "PIRELA G STRAIGHT"	1
4	32S06U01-40-012	REAR DOOR GLASS SOLID	1
5	32S06U01-40-014	LEFT REAR DOOR WINDOW FRAME	1
6	32S06U01-40-013	REAR DOOR GLASS MOVABLE	1
7	001700	GLASS LOCK	1
8	001762	DOOR GLASS STOP	1
9	32S06U01-40W003	LEFT UPPER CORNER WELDED	1
10	32S06U01-40-021	UPPER CORNER EPDM	1
11	32S06U01-40-022	UPPER CORNER LEDGE	1
12	001387	WASHER 8	14
13	001388	SELF-LOCKING NUT M8	12
14	001309	PLASTIC NUT COVER OK13	16
15	001348	PLASTIC NUT COVER OK10	6
16	001392	SELF-LOCKING NUT M6	6
17	001426	WASHER 6	6
18	001735	RUBBER WASHER 6	21
19	001715	PLASTIC WASHER 6	21
20	002952	SCREW M6x35	2
21	32S06U01-40-019	MIDDLE COVER LEDGE	1
22	32S06U01-40-018	MIDDLE COVER EPDM	1
23	32S05U01-40-016	DOOR LOCK INNER LEDGE	1
24	001703	HANDLE	1
25	000841	OUTER DOOR LOCK	1
26	001743	LEFT INNER DOOR LOCK	1
27	001407	WASHER 8 LARGE	2
28	002575	SCREW M8x20	2
29	32S06U01-40-008	LEFT REAR DOOR STOP HOLDER	1
30	000856	DOOR STOP NUT	1
31	000857	DOOR STOP WASHER	1
32	000855	DOOR STOP HOOK	1
33	000854	DOOR STOP PIN	1
34	001761	SCREW M6x20	2
35	001736	SEAT WASHER 6	13
36	002120	SCREW M6x25	17
37	32S06U01-40W001	LEFT REAR DOOR FRAME	1
38	32S06U01-40-011	DOOR BOTTOM LEDGE	1
39	32S06U01-40-010	DOOR BOTTOM EPDM	1
40	32S06U01-40W002	LEFT DOOR BOTTOM WELDED	1
41	001411	SCREW M8x30	4
42	32S05U01-40W003	LEFT DOOR HINGE WELDED	2
43	001430	LUBRICATOR	2
44	001431	LUBRICATOR COVER	2

RIGHT TABLE

Position	Catalogue no.	Description	Qty
1	32S06U01-40-035	RUBBER PROFILE "SARAZIN SIDE"	1
2	32S06U01-50-001	RIGHT REAR DOOR PANEL POLY	1
3	32S06U01-40-036	RUBBER PROFILE "PIRELA G STRAIGHT"	1
4	32S06U01-40-012	REAR DOOR GLASS SOLID	1
5	32S06U01-50-014	RIGHT REAR DOOR WINDOW FRAME	1
6	32S06U01-40-013	REAR DOOR GLASS MOVABLE	1
7	001700	GLASS LOCK	1
8	001762	DOOR GLASS STOP	1
9	32S06U01-50W003	RIGHT UPPER CORNER WELDED	1
10	32S06U01-40-021	UPPER CORNER EPDM	1
11	32S06U01-40-022	UPPER CORNER LEDGE	1
12	001387	WASHER 8	14
13	001388	SELF-LOCKING NUT M8	12
14	001309	PLASTIC NUT COVER OK13	16
15	001348	PLASTIC NUT COVER OK10	6
16	001392	SELF-LOCKING NUT M6	6
17	001426	WASHER 6	6
18	001735	RUBBER WASHER 6	21
19	001715	PLASTIC WASHER 6	21
20	002952	SCREW M6x35	2
21	32S06U01-40-019	MIDDLE COVER LEDGE	1
22	32S06U01-40-018	MIDDLE COVER EPDM	1
23	32S05U01-40-016	DOOR LOCK INNER LEDGE	1
24	001703	HANDLE	1
25	000841	OUTER DOOR LOCK	1
26	001744	RIGHT INNER DOOR LOCK	1
27	001407	WASHER 8 LARGE	2
28	002575	SCREW M8x20	2
29	32S06U01-50-008	RIGHT REAR DOOR STOP HOLDER	1
30	000856	DOOR STOP NUT	1
31	000857	DOOR STOP WASHER	1
32	000855	DOOR STOP HOOK	1
33	000854	DOOR STOP PIN	1
34	001761	SCREW M6x20	2
35	001736	SEAT WASHER 6	13
36	002120	SCREW M6x25	17
37	32S06U01-50W001	RIGHT REAR DOOR FRAME	1
38	32S06U01-40-011	DOOR BOTTOM LEDGE	1
39	32S06U01-40-010	DOOR BOTTOM EPDM	1
40	32S06U01-50W002	RIGHT DOOR BOTTOM WELDED	1
41	001411	SCREW M8x30	4
42	32S05U01-50W003	RIGHT DOOR HINGE WELDED	2
43	001430	LUBRICATOR	2
44	001431	LUBRICATOR COVER	2

ELECTROINSTALLATION

Position	Catalogue no.	Description	Qty
1	000968	SWITCH WIPER /WASHER /OFF	1
2	000885	WASHER TANK	1
3	001576	WASHER MOTOR	1
4	001652	FUSE BOX 2x1	1
5	002764	WIPER MOTOR 12V	1
6	32S05U01-01M001	WIPER HARNESS	1
7	32S05U01-02-001	HEATER HOLDER	1
8	002491	AIR VENT VALVE	1
9	002386	ELECTROMAGNETIC VALVE	1
10	001367	TIGHTENING STRAP 12-22MM	2
11	002642	TIGHTENING STRAP 14-27MM	10
12	002643	TIGHTENING STRAP 21-38MM	2
13	001368	TIGHTENING STRAP 40-60MM	4
14	002863	AIR VENT SMALLER	2
15	002379	AIR VENT BIGGER	2
16	002795	AIR HOSE	1
17	002705	AL SELFGLUED TAPE	1
18	003536	HEATER TUBE "Y" SMALLER	1
19	002502	HEATER TUBE "Y"	1
20	002391	EL.VENT SWITCH	1
21	002702	HEATER SWITCH	1
22	32S05U01-02M001	HEATER HARNESS	1
23	000896	HEATER HOSE	1
24	002624	HEATER	1
25	32S05U01-03M001	WASHER HARNESS	1

SEE PICTURES ON NEXT PAGES

FOR ALL TECHNICAL QUESTIONS, PLEASE CALL
 DFK AMERICA INC.
 (630) 324-8585

<p>Position : 1 Catalogue no.: 000968</p>	<p>Position : 2 Catalogue no.: 000885</p>	<p>Position : 3 Catalogue no.: 001576</p>
<p>Position : 4 Catalogue no.: 001652</p>	<p>Position : 5 Catalogue no.: 002764</p>	<p>Position : 6 Catalogue no.: 32S05U01-01M001</p>
<p>Position : 7 Catalogue no.: 32S05U01-02-001</p>	<p>Position : 8 Catalogue no.: 002491</p>	<p>Position : 9 Catalogue no.: 002386</p>

Position : 10	Position : 11	Position : 12
Catalogue no.: 001367	Catalogue no.: 002642	Catalogue no.: 002643
Position : 13	Position : 14	Position : 15
Catalogue no.: 001368	Catalogue no.: 002863	Catalogue no.: 002739
Position : 16	Position : 17	Position : 18
Catalogue no.: 002795	Catalogue no.: 002705	Catalogue no.: 003536

<p>Position : 19 Catalogue no.: 002502</p>	<p>Position :20 Catalogue no.: 002391</p>	<p>Position : 21 Catalogue no.: 002702</p>
<p>Position : 22 Catalogue no.: 32S05U01-02M001</p>	<p>Position : 23 Catalogue no.: 000896</p>	<p>Position : 24 Catalogue no.: 002624</p>
<p>Position : 25 Catalogue no.: 32S05U01-03M001</p>		