

# HardCabs

A DFK AMERICA COMPANY

SPARE - PARTS CATALOG

## **CAN-AM** **COMMANDER 1000 LIMITED**



CAB PREVIEW

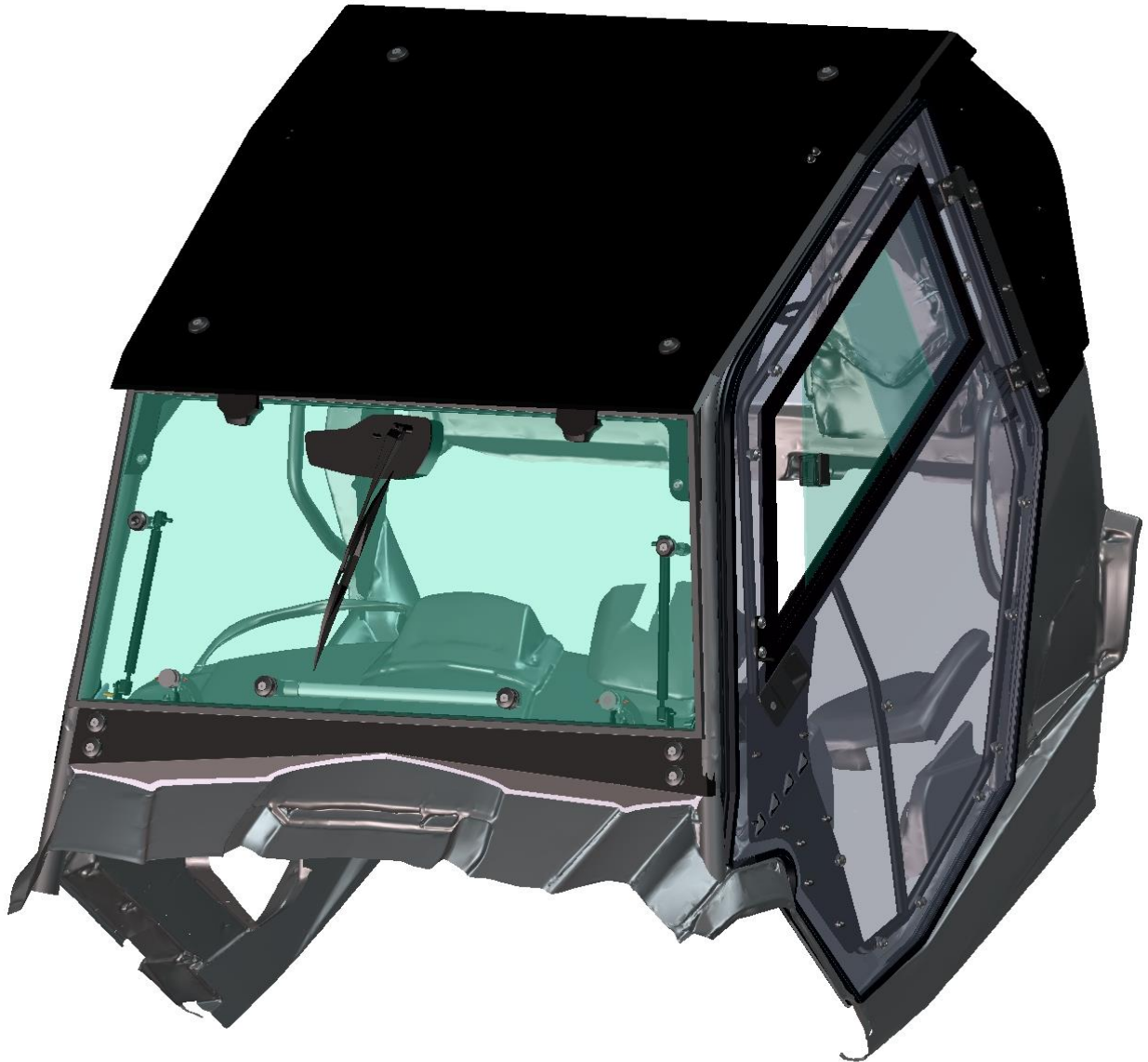

2

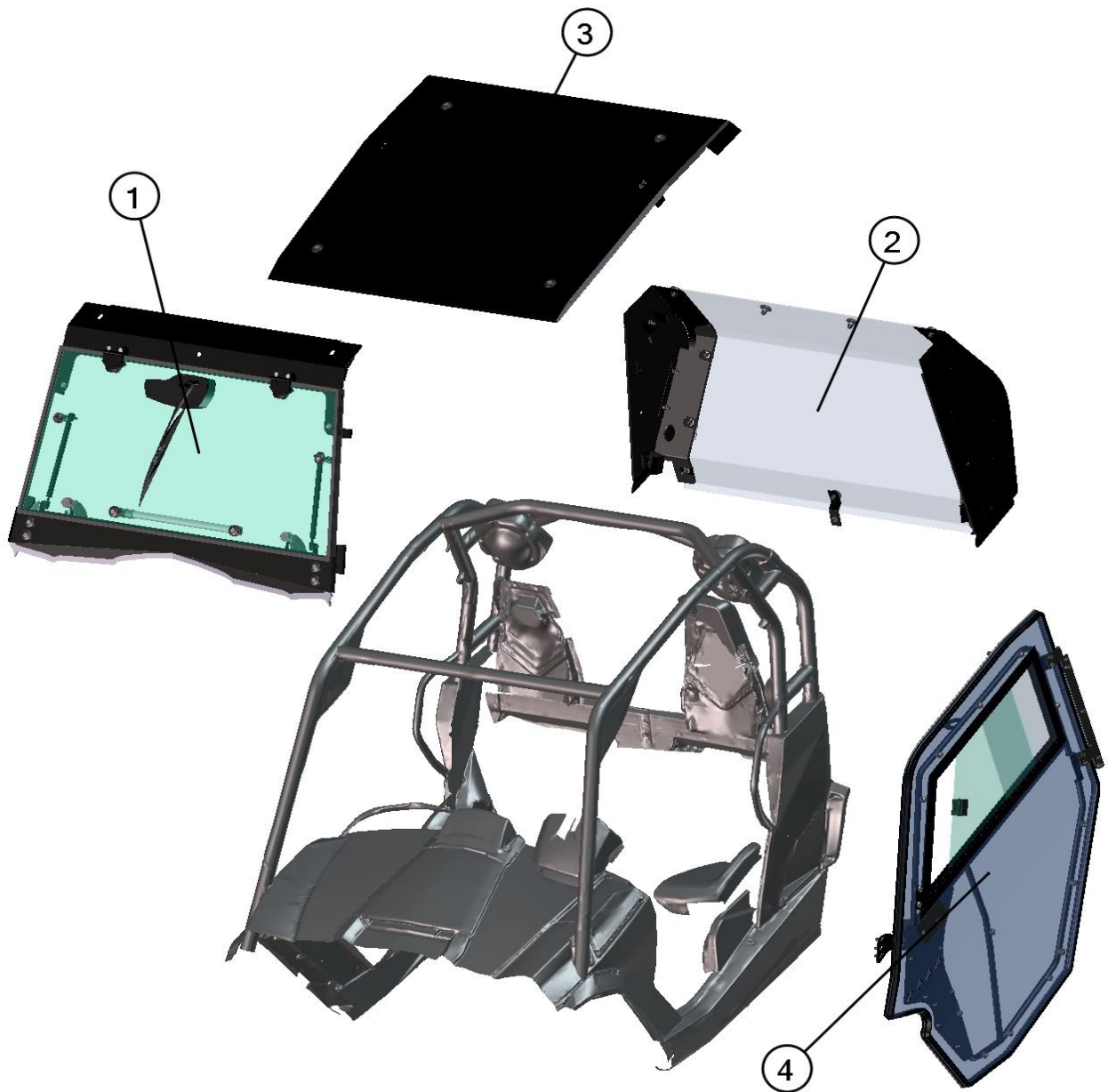

3

Position	Catalogue no.	Description	Qty
1	52S01U01S10	FRONT PANEL MOVABLE	1
2	52S01U01S20	REAR PANEL	1
3	52S01U01S30	ROOF	1
4	52S01U01S40	LEFT DOOR	1

**FOR DEMAND RIGHT DOOR USE CATALOGUE NO.: 52S01U01S50  
(LEFT and RIGHT DOOR are similar, just use correct table)**

FRONT PANEL

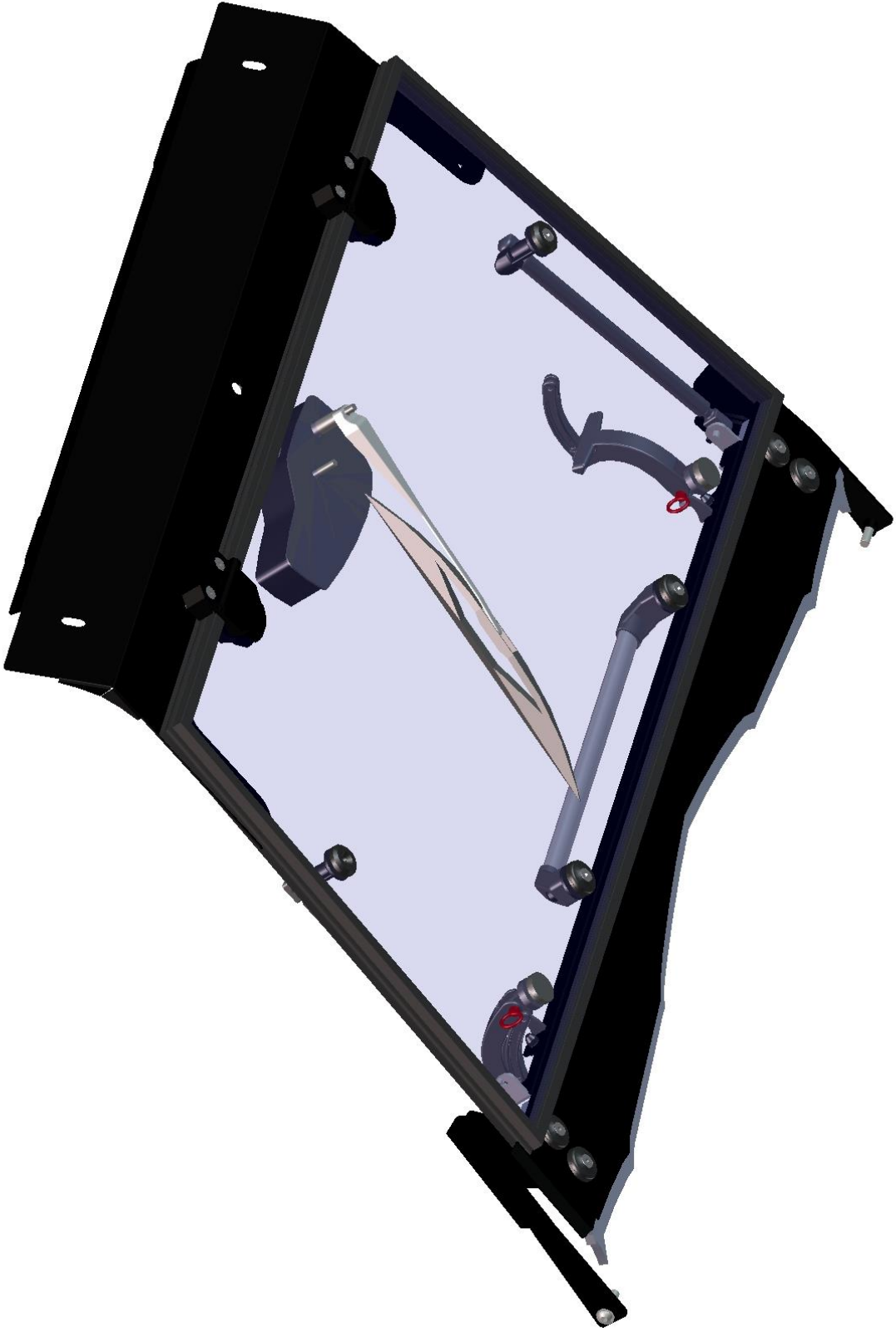

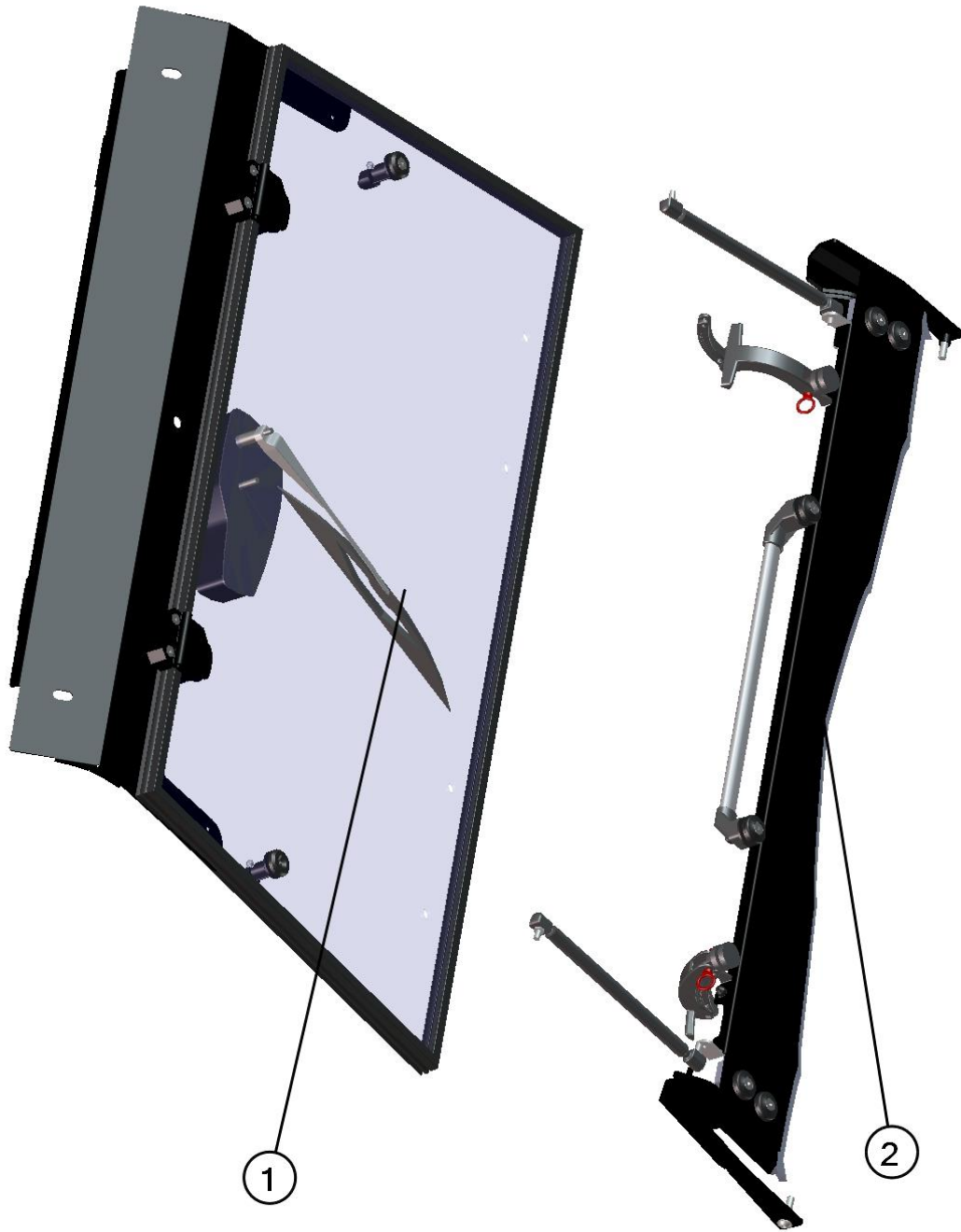

5

Position	Catalogue no.	Description	Qty
1	*****	FRONT UPPER ASSEMBLY	1
2	*****	FRONT BOTTOM ASSEMBLY	1

FRONT UPPER ASSEMBLY



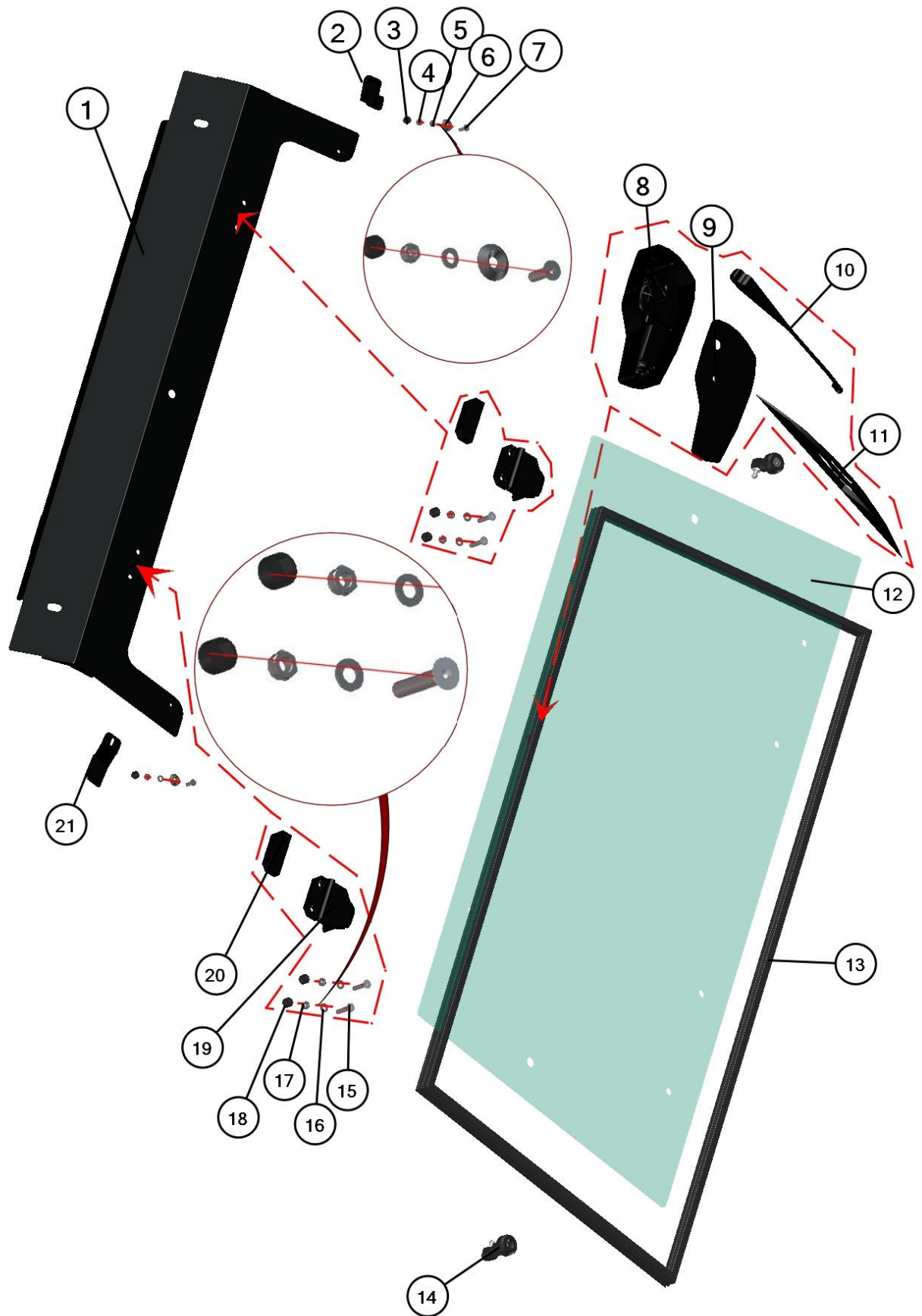

Position	Catalogue no.	Description	Qty
1	52S01U01-10-003	FRONT UPPER PANEL	1
2	52S01U01-10-010	LEFT UPPER FRONT HOLDER	1
3	001348	PLASTIC NUT COVER OK 10	2
4	001392	SELF-LOCKING NUT M8	2
5	001426	WASHER 6	2
6	001715	PLASTIC WASHER 6	2
7	001761	SCREW M6x 20	2
8	002764	WIPER MOTOR 12V	1
9	00-025E02	WIPER MOTOR LEDGE	1
10	002535	WIPER ARM	1
11	002538	WIPER LATCH	1
12	52S01U01-10-002	FRONT GLASS MOVABLE	1
13	001012^52S01U01-10M002	RUBBER PROFILE "PIRELA GLASS"	1
14	0001693	GAS SPRING HOLDER	2
15	002607	SCREW M8x40	4
16	001387	WASHER 8	4
17	001388	SELF-LOCKING NUT M8	4
18	001309	PLASTIC NUT COVER OK 13	4
19	000862	HINGE	2
20	000863	HINGE WASHER	2
21	52S01U01-10-011	RIGHT UPPER FRONT HOLDER	1



FRONT BOTTOM ASSEMBLY



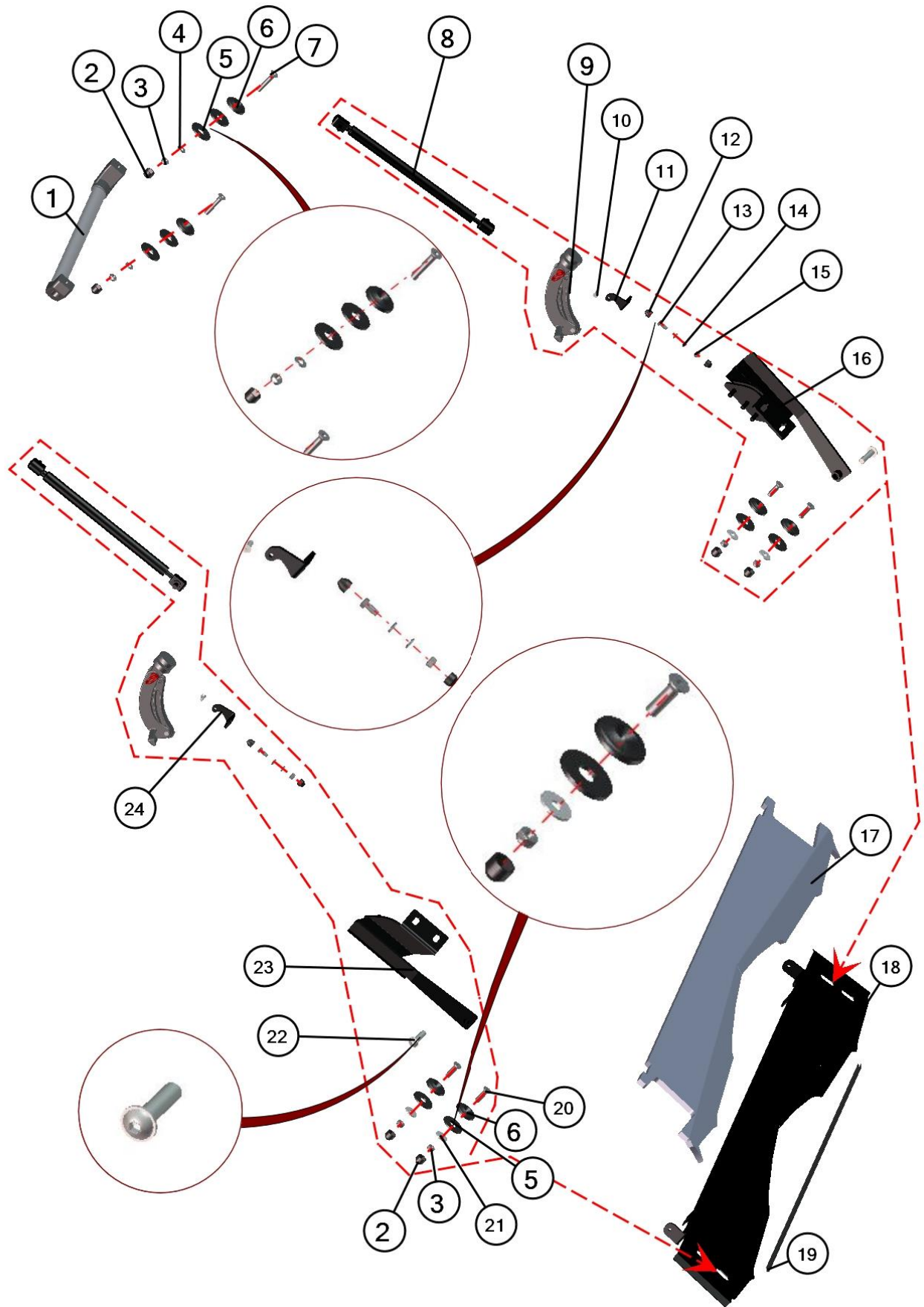

10

Position	Catalogue no.	Description	Qty
1	002496	FRONT GLASS HANDLE	1
2	001309	PLASTIC NUT COVER OK 13	6
3	001388	SELF-LOCKING NUT M8	6
4	001387	WASHER 8	2
5	001428	RUBBER WASHER 8	8
6	001429	PLASTIC WASHER 8	6
7	001694	SCREW M8x45	2
8	000868	GAS SPRING	2
9	002389	FRONT WINDOW LOCK	2
10	002342	SCREW M5x16	2
11	00-112U-003	LEFT WINDOW LOCK HOLDER	1
12	001348	PLASTIC NUT COVER OK 10	4
13	001435	SCREW M6x14	2
14	001426	WASHER 6	4
15	001392	SELF-LOCKING NUT M8	2
16	52S01U01-10W002	LEFT BOTTOM LEDGE HOLDER	1
17	52S01U01-10-006	FRONT BOTTOM LEDGE EPDM	1
18	52S01U01-10W001	BOTTOM LEDGE WELDED	1
19	001001^52S01U01-10M001	RTUBBER PROFILE "LEMOVKA"	1
20	002121	SCREW M8x30	4
21	001407	WASHER 8 LARGE	4
22	002768	SCREW M10x50	2
23	52S01U01-10W004	RIGHT BOTTOM LEDGE HOLDER	1
24	00-112U-002	RIGHT WINDOW LOCK HOLDER	1

REAR PANEL

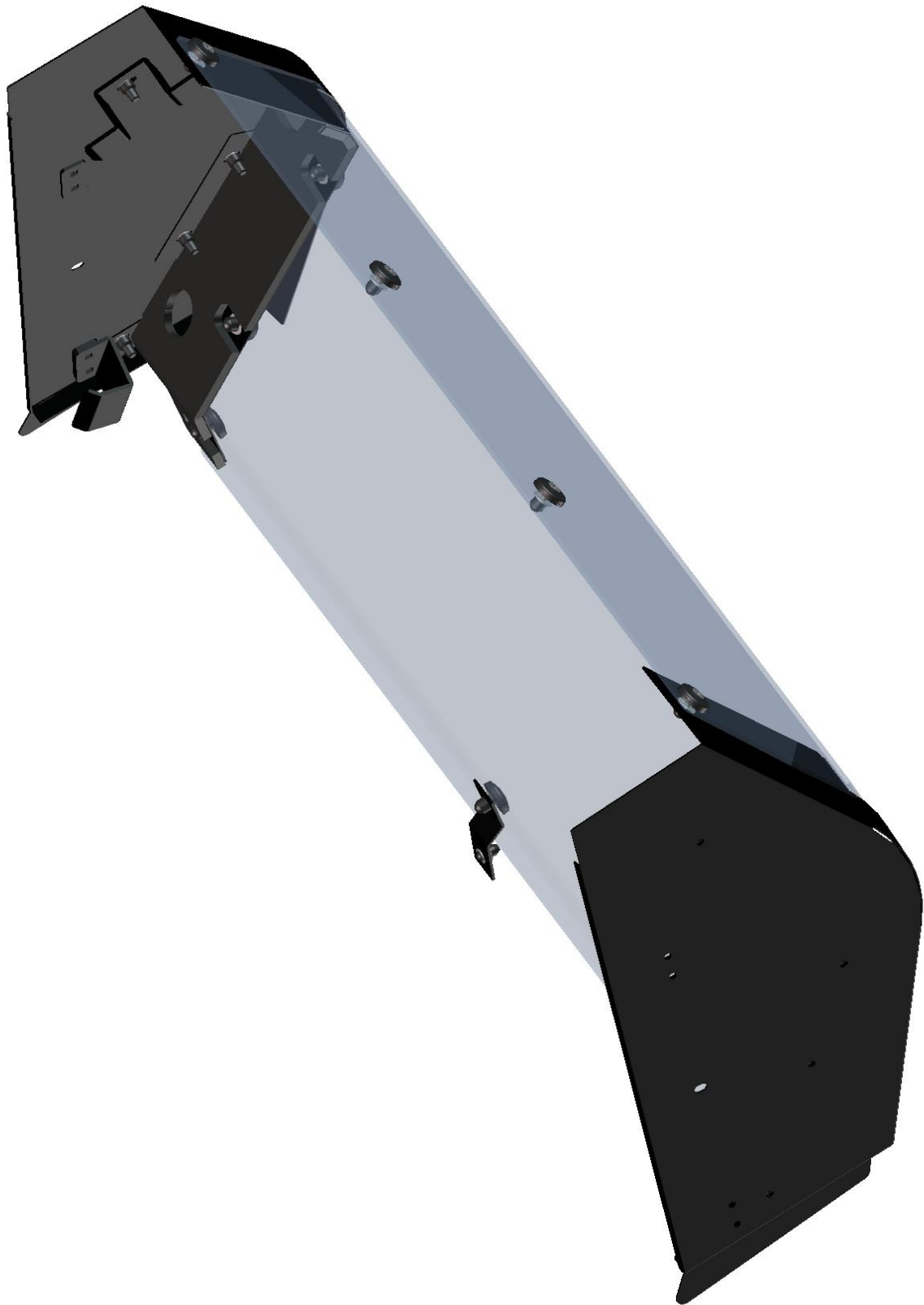

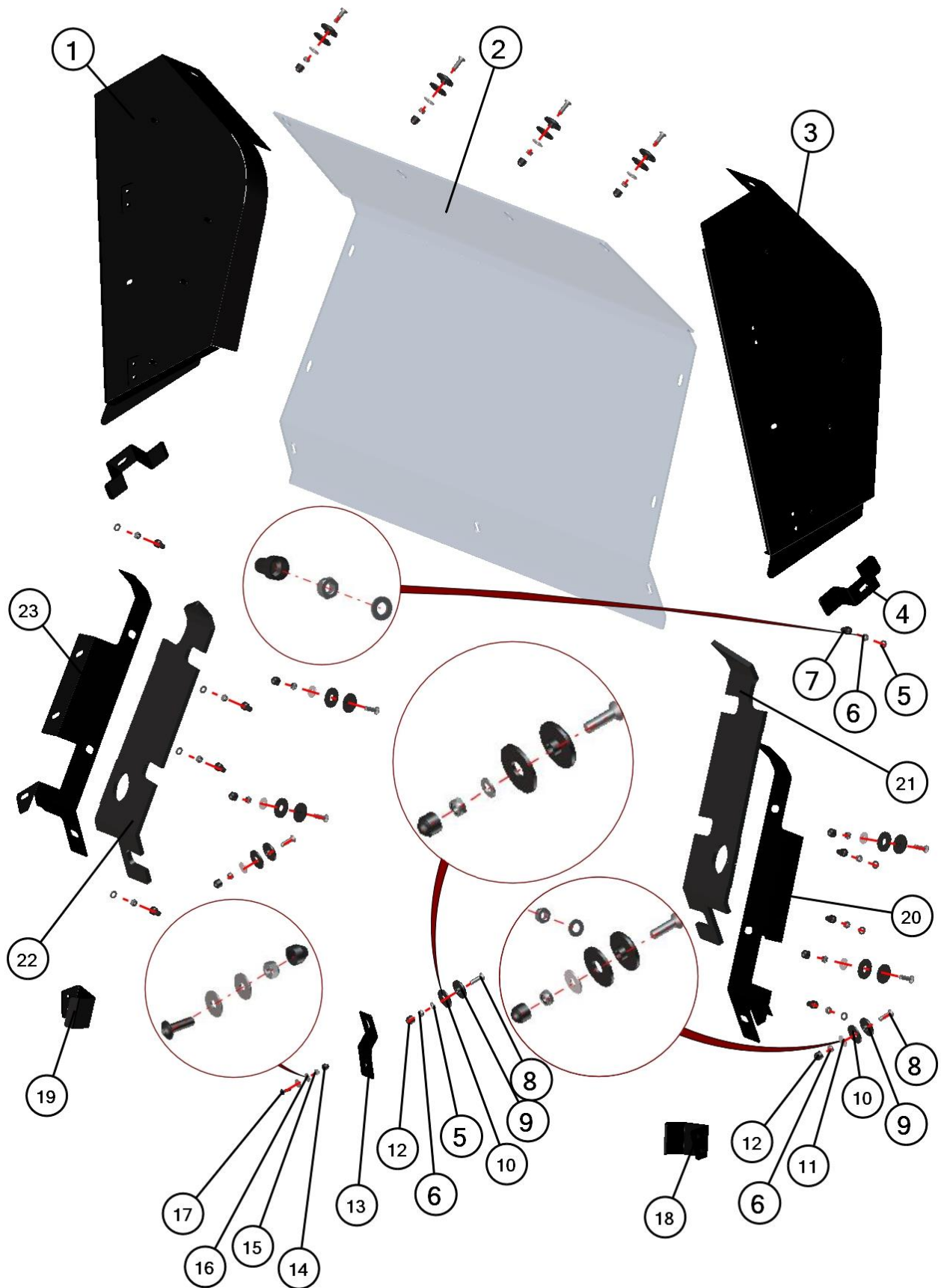

13

Position	Catalogue no.	Description	Qty
1	52S01U01-20W002	RIGHT DOOR BASE WELDED	1
2	52S01U01-20-004	REAR WINDOW POLYCARBONATE	1
3	52S01U01-20W001	LEFT DOOR BASE BASE	1
4	52S01U01-20-012	DOOR BASE UPPER HOLDER	2
5	001387	WASHER 8	9
6	001388	SELF-LOCKING NUT M8	19
7	001308	PLASTIC NUT COVER OK13 LONG	8
8	002121	SCREW M8x30	11
9	001429	PLASTIC WASHER 8	11
10	001428	RUBBER WASHER 8	11
11	001407	WASHER 8 LARGE	10
12	001309	PLASTIC NUT COVER OK13	11
13	52S01U01-20-003	REAR WINDOW BOTTOM HOLDER	1
14	001348	PLASTIC NUT COVER OK10	1
15	001392	SELF-LOCKING NUT M6	1
16	001337	WASHER 6 LARGE	2
17	001723	SCREW M6x20	1
18	52S01U01-20-013	DOOR BASE BOTTOM HOLDER LEFT	1
19	52S01U01-20-014	DOOR BASE BOTTOM HOLDER RIGHT	1
20	52S01U01-20-005	LEFT REAR LEDGE METAL	1
21	52S01U01-20-006	LEFT REAR LEDGE EPDM	1
22	52S01U01-20-011	RIGHT REAR LEDGE EPDM	1
23	52S01U01	RIGHT REAR LEDGE METAL	1

ROOF



15

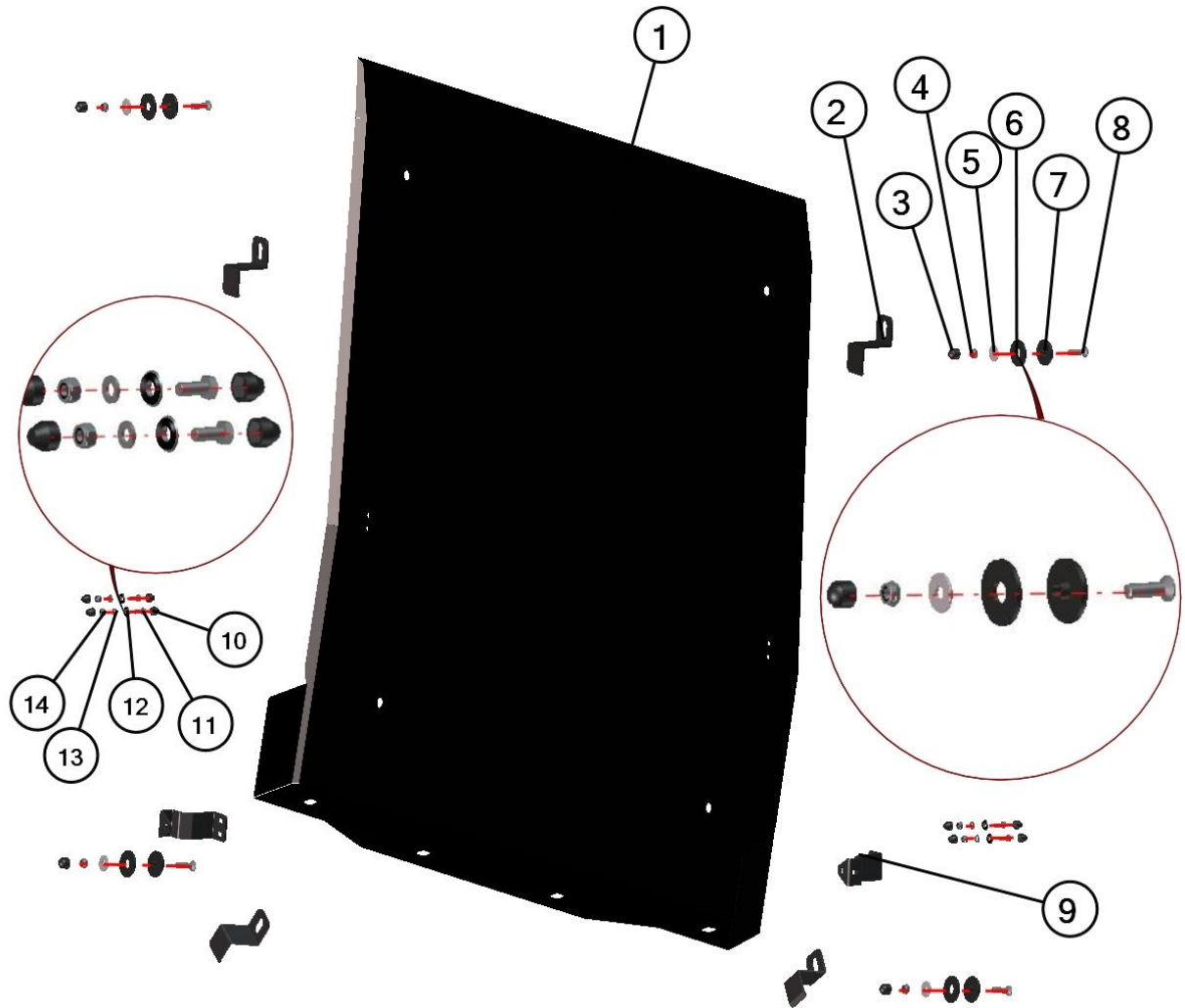

16

Position	Catalogue no.	Description	Qty
1	52S01U01-30-001	ROOF PANEL	1
2	52S01U01-30-002	ROOF HOLDER	4
3	001309	PLASTIC NUT COVER OK13	4
4	001388	SELF-LOCKING NUT M8	4
5	001407	WASHER 8 LARGE	4
6	001428	RUBBER WASHER 8	4
7	001429	PLASTIC WASHER 8	4
8	002121	SCREW M8x30	4
9	52S01U01-30-003	GAS SPRING HOLDER	2
10	001348	PLASTIC NUT COVER OK10	8
11	001435	SCREW M6x14	4
12	001494	WASHER WITH SEAL 7	4
13	001426	WASHER 6	4
14	001392	SELF-LOCKING NUT M6	4



LEFT DOOR+RIGHT DOOR

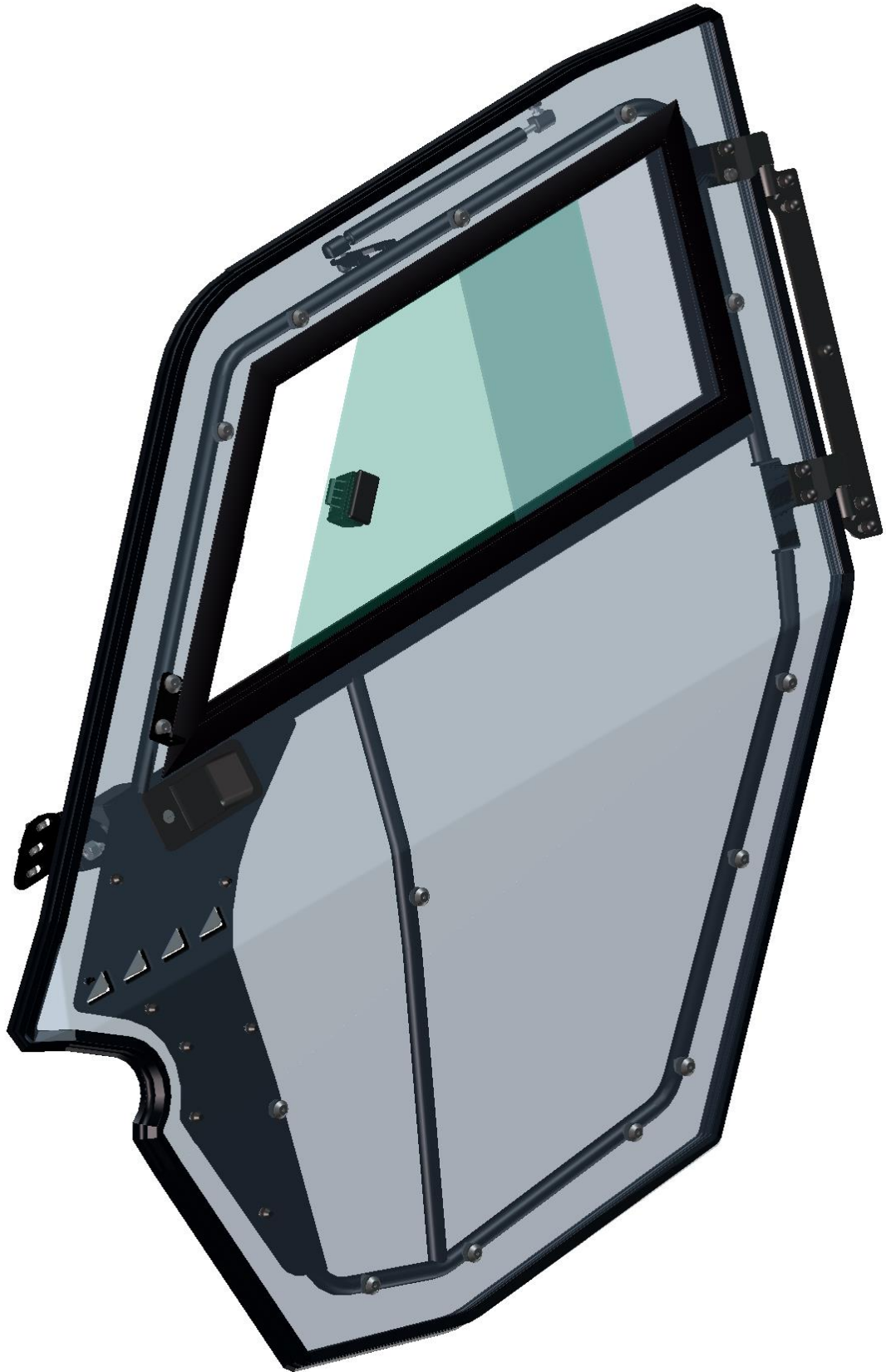



Position	Catalogue no.	Description	Qty
1	-----	DOOR FRAME ASSEMBLY WITH HINGES	1
2	-----	DOOR PANEL WITH WINDOW AND LOCK	1

DOOR FRAME ASSEMBLY WITH HINGES



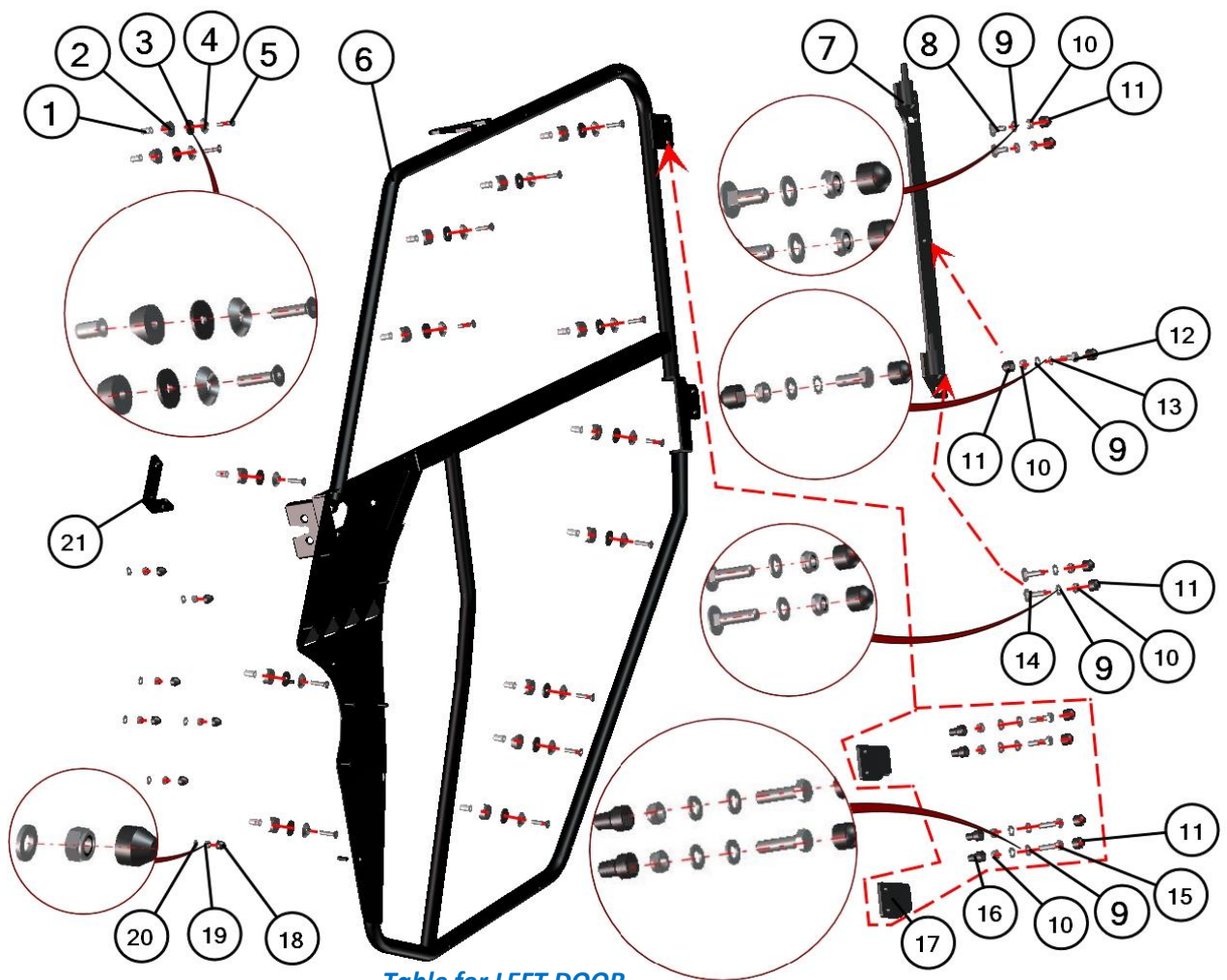

Table for LEFT DOOR

Position	Catalogue no.	Description	Qty
1	001397	RIVET NUT M6	15
2	001736	RUBBER WASHER 6 SEAT	15
3	001735	RUBBER WASHER 6	15
4	001715	PLASTIC WASHER	15
5	002120	SCREW M6x25	15
6	52S01U01-40W001	LEFT DOOR FRAME WELDED	1
7	52S01U01-40W004	LEFT HINGE LEDGE WELDED	1
8	002575	SELF-LOCK SCREW M8x20	2
9	001387	WASHER 8	13
10	001388	SELF-LOCKING NUT M8	9
11	001309	PLASTIC NUT COVER OK13	11
12	001437	SCREW M8x20	1
13	001489	SERRATED-LOCK WASHER 8	1
14	002603	SELF-LOCK SCREW M8x30	2
15	001411	SCREW M8x30	4
16	001308	PLASTIC NUT COVER OK13 LONG	4
17	52S01U01-40W002	LEFT HINGE DOOR	2
18	001348	PLASTIC NUT COVER OK10	7
19	001392	SELF-LOCKING NUT M6	7
20	001426	WASHER 6	7
21	52S01U01-40-020	REAR MIRROR HOLDER	1

20

*Table for RIGHT DOOR*

Position	Catalogue no.	Description	Qty
1	001397	RIVET NUT M6	15
2	001736	RUBBER WASHER 6 SEAT	15
3	001735	RUBBER WASHER 6	15
4	001715	PLASTIC WASHER	15
5	002120	SCREW M6x25	15
6	52S01U01-50W001	RIGHT DOOR FRAME WELDED	1
7	52S01U01-50W004	RIGHT HINGE LEDGE WELDED	1
8	002575	SELF-LOCK SCREW M8x20	2
9	001387	WASHER 8	13
10	001388	SELF-LOCKING NUT M8	9
11	001309	PLASTIC NUT COVER OK13	11
12	001437	SCREW M8x20	1
13	001489	SERRATED-LOCK WASHER 8	1
14	002603	SELF-LOCK SCREW M8x30	2
15	001411	SCREW M8x30	4
16	001308	PLASTIC NUT COVER OK13 LONG	4
17	52S01U01-50W002	RIGHT HINGE DOOR	2
18	001348	PLASTIC NUT COVER OK10	7
19	001392	SELF-LOCKING NUT M6	7
20	001426	WASHER 6	7
21	52S01U01-40-020	REAR MIRROR HOLDER	1

DOOR PANEL WITH WINDOW AND LOCK

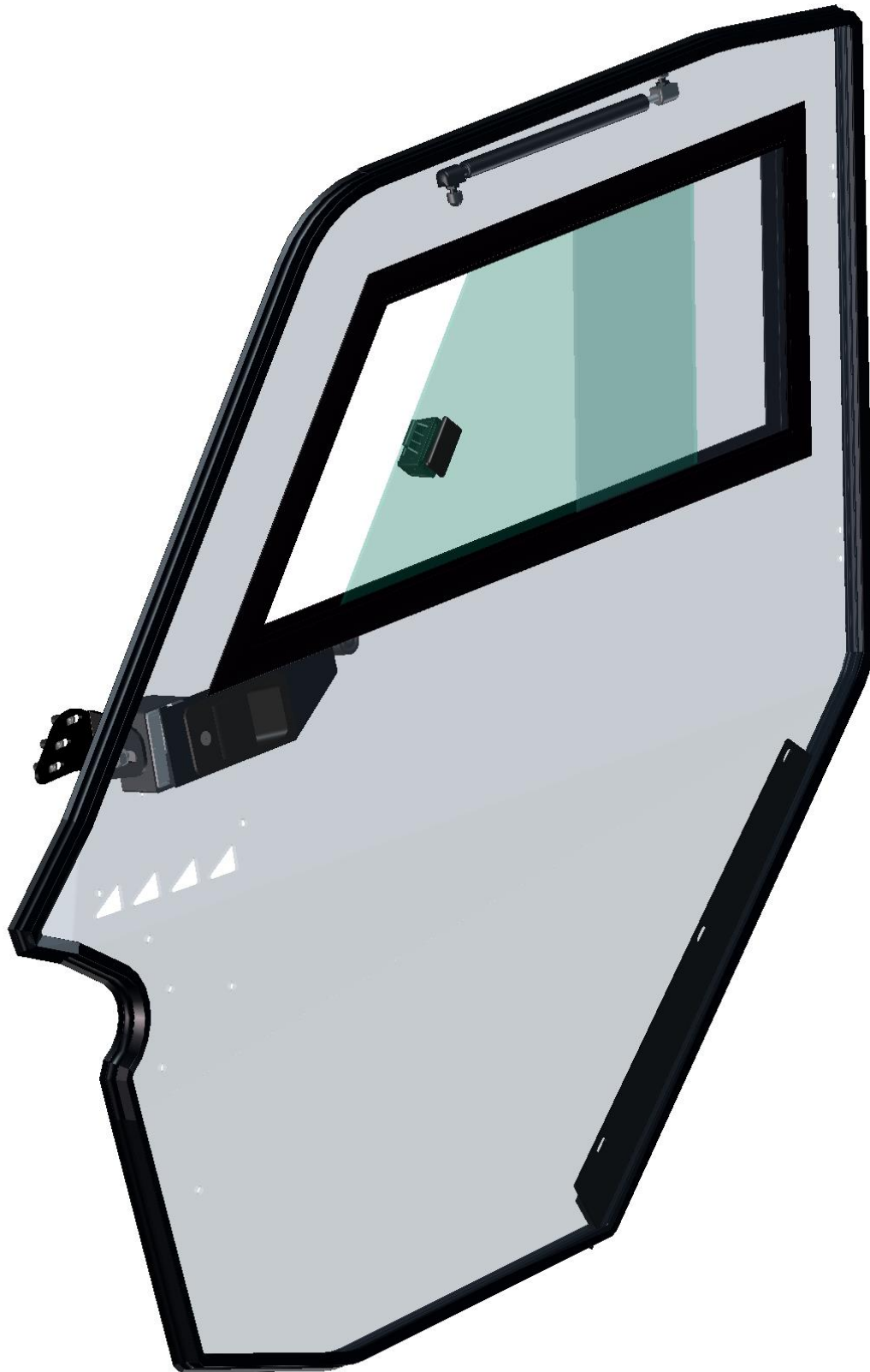

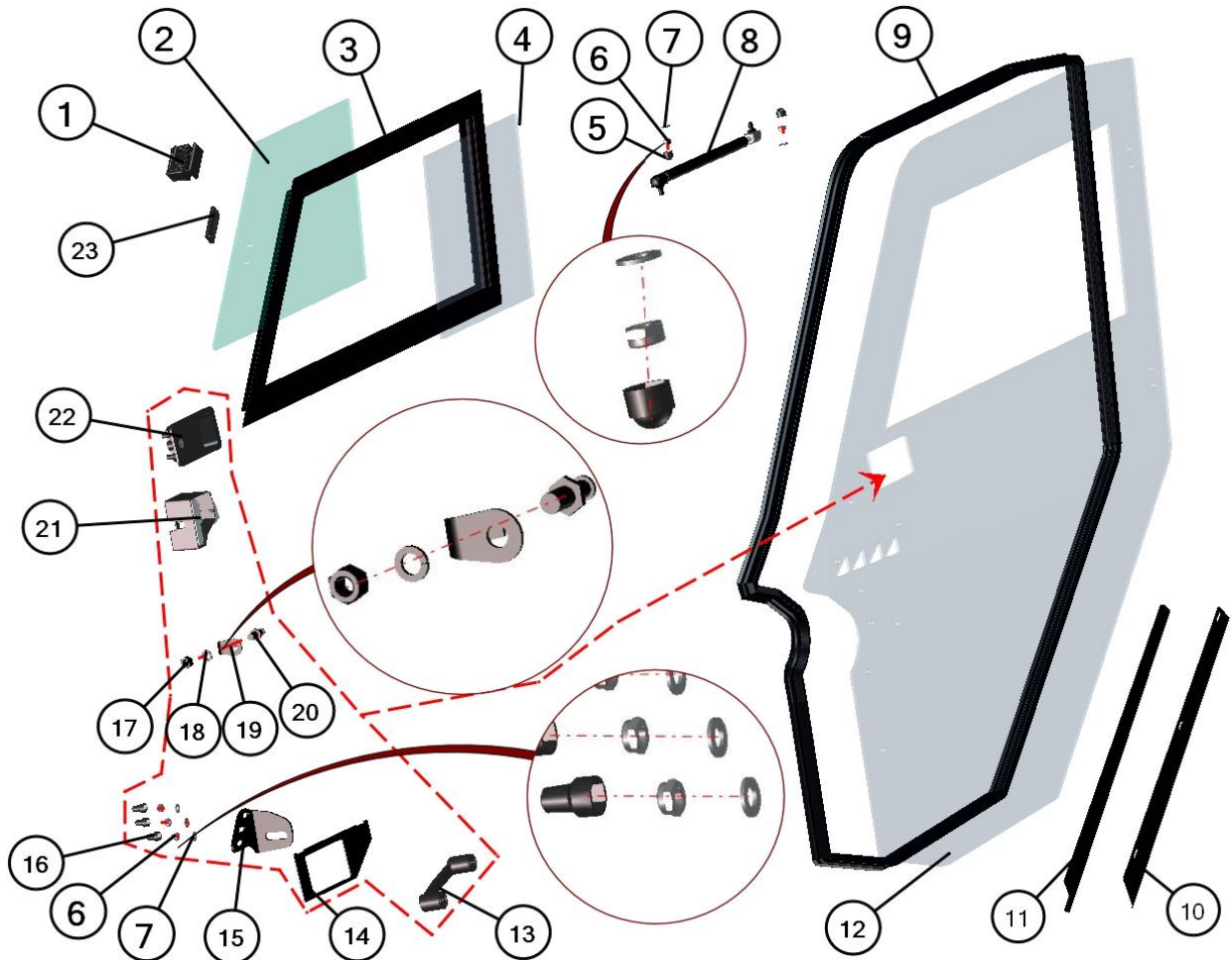

23

**Table for LEFT DOOR**

Position	Catalogue no.	Description	Qty
1	001700	GLASS LOCK	1
2	52S01U01-40-011	DOOR WINDOW MOVABLE	1
3	52S01U01-40-005	LEFT DOOR WINDOW FRAME PVC	1
4	52S01U01-40-012	DOOR WINDOW SOLID POLYCARBONATE	1
5	001309	PLASTIC NUT COVER OK13	2
6	001388	SELF-LOCKING NUT M8	5
7	001387	WASHER 8	5
8	000865	GAS SPRING	1
9	002454*52S01U01S40	RUBBER PROFILE "SARAZIN SIDE"	1
10	52S01U01-40-026	DOOR LEDGE BOTTOM METAL	1
11	52S01U01-40-028	DOOR LEDGE BOTTOM EPDM	1
12	52S01U01-40-001	LEFT DOOR PANEL POLYCARBONATE	1
13	001703	DOOR HANDLE	1
14	52S01U01-40-014	MIDDLE DOOR LOCK COVER	1
15	52S01U01-40-016	LEFT DOOR STOP HOLDER	1
16	001308	PLASTIC NUT COVER OK13 LONG	3
17	000856	DOOR STOP NUT	1
18	000857	DOOR STOP WASHER	1
19	000855	DOOR STOP HOOK	1
20	000854	DOOR STOP PIN	1
21	001743	LEFT INNER DOOR LOCK	1
22	000841	OUTER DOOR LOCK	1
23	001762	GLASS STOP	1

*Table for RIGHT DOOR*

Position	Catalogue no.	Description	Qty
1	001700	GLASS LOCK	1
2	52S01U01-40-011	DOOR WINDOW MOVABLE	1
3	52S01U01-50-005	RIGHT DOOR WINDOW FRAME PVC	1
4	52S01U01-40-012	DOOR WINDOW SOLID POLYCARBONATE	1
5	001309	PLASTIC NUT COVER OK13	2
6	001388	SELF-LOCKING NUT M8	5
7	001387	WASHER 8	5
8	000865	GAS SPRING	1
9	002454^52S01U01S50	RUBBER PROFILE "SARAZIN SIDE"	1
10	52S01U01-50-026	RIGHT DOOR LEDGE BOTTOM METAL	1
11	52S01U01-40-028	DOOR LEDGE BOTTOM EPDM	1
12	52S01U01-50-001	RIGHT DOOR PANEL POLYCARBONATE	1
13	001703	DOOR HANDLE	1
14	52S01U01-40-014	MIDDLE DOOR LOCK COVER	1
15	52S01U01-50-016	RIGHT DOOR STOP HOLDER	1
16	001308	PLASTIC NUT COVER OK13 LONG	3
17	000856	DOOR STOP NUT	1
18	000857	DOOR STOP WASHER	1
19	000855	DOOR STOP HOOK	1
20	000854	DOOR STOP PIN	1
21	001744	RIGHT INNER DOOR LOCK	1
22	000841	OUTER DOOR LOCK	1
23	001762	GLASS STOP	1



**ELECTROINSTALLATION**  
Overall wiring diagram

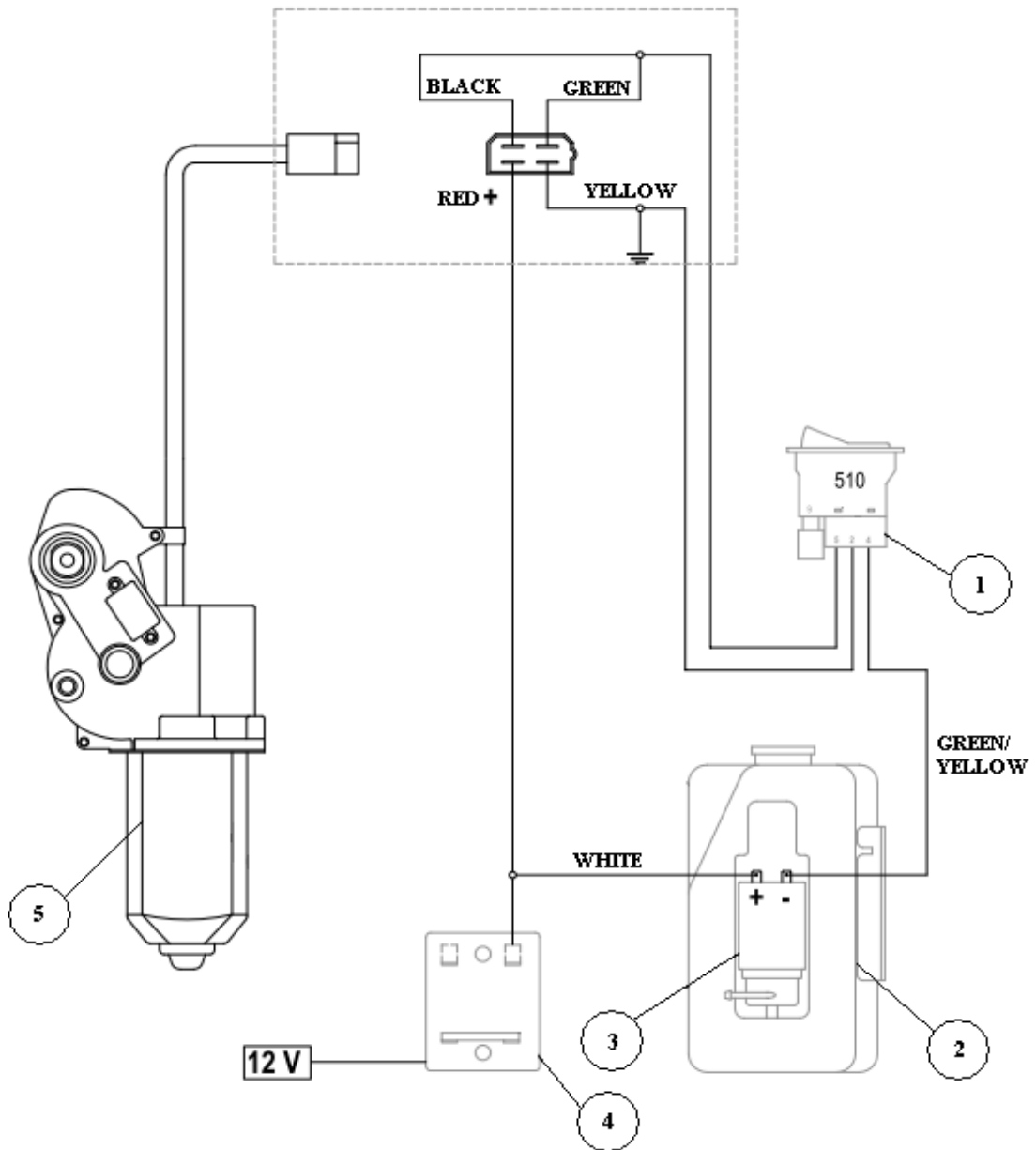

Position	Catalogue no.	Description	Qty
1	000968	SWITCH WIPER /WASHER /OFF	1
2	000885	WASHER TANK COMPLETE	1
3	001576	WASHER MOTOR	1
4	001652	FUSE BOX WITH FUSE	1
5	002764	WIPER MOTOR 12V	1
6	000881	WASHER TUBE	1
7	52S01U01-01M001	HARNESS WIPER/WASHER	1
8	002017	FRONT UPPER LEDGE BUSHING	1



**Position : 1**  
**Catalogue no.: 000968**



**Position : 2**  
**Catalogue no.: 000885**



**Position : 3**  
**Catalogue no.: 001576**

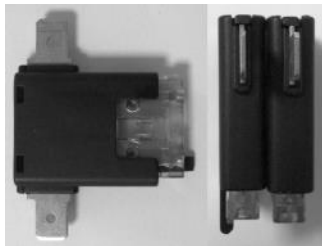

**Position : 4**  
**Catalogue no.: 001652**



**Position : 5**  
**Catalogue no.: 002764**



**Position : 6**  
**Catalogue no.: 000881**



**Position : 7**  
**Catalogue no.: 52S01U01-01M001**



**Position : 8**  
**Catalogue no.: 002017**