

HardCabs

A DFK AMERICA COMPANY

SPARE - PARTS CATALOG

ARCTIC CAT **PROWLER 700i HDX (2016)**



CAB PREVIEW



2

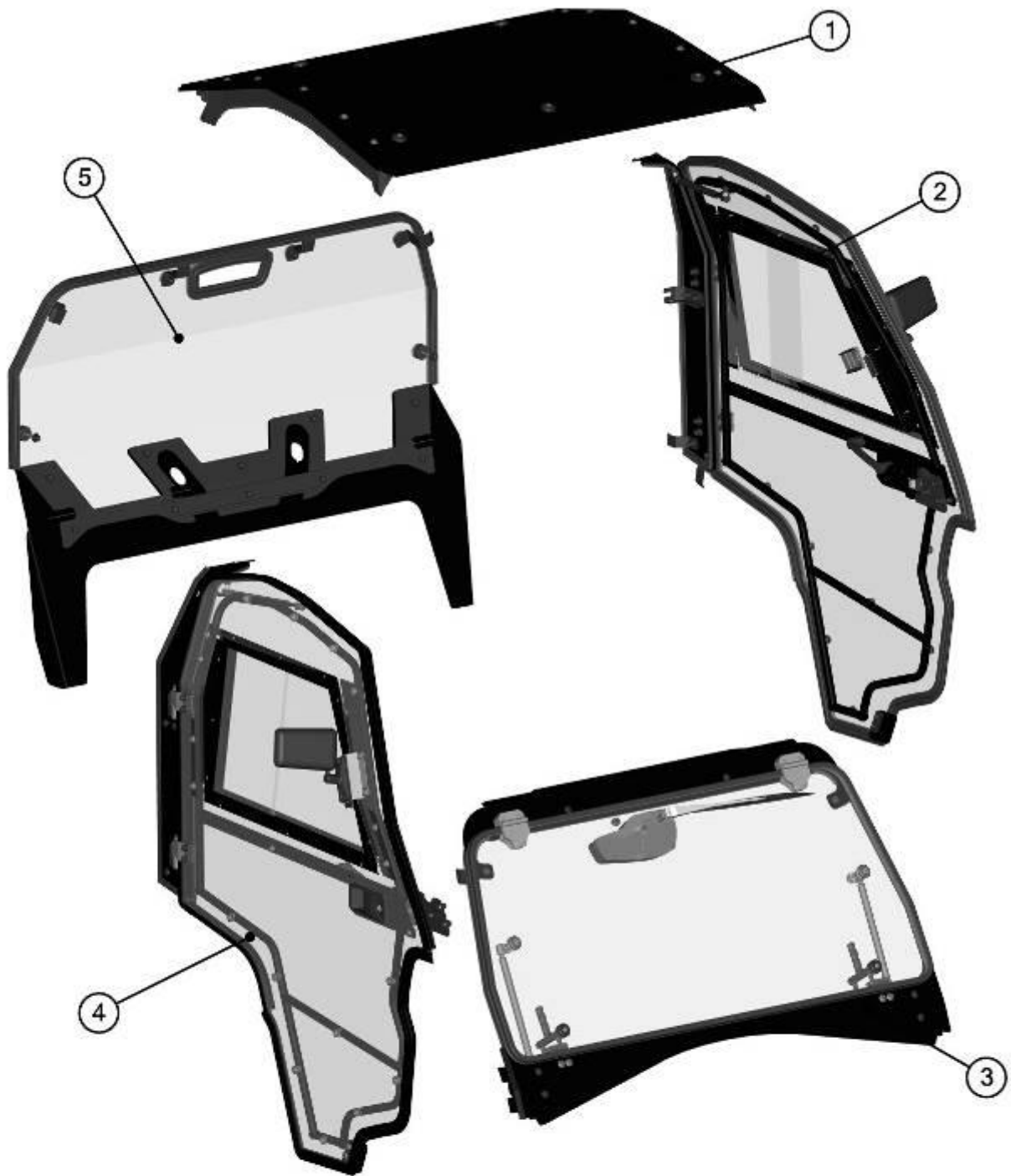

3

ID	Catalogue no.	Description	Qty
1	61S02U02S30	ROOF	1
2	61S02U02S40	LEFT DOOR ASSEMBLY	1
3	61S02U02S10	FRONT PANEL	1
4	61S02U02S50	RIGHT DOOR ASSEMBLY	1
5	61S02U02S20	REAR PANEL	1

FRONT PANEL



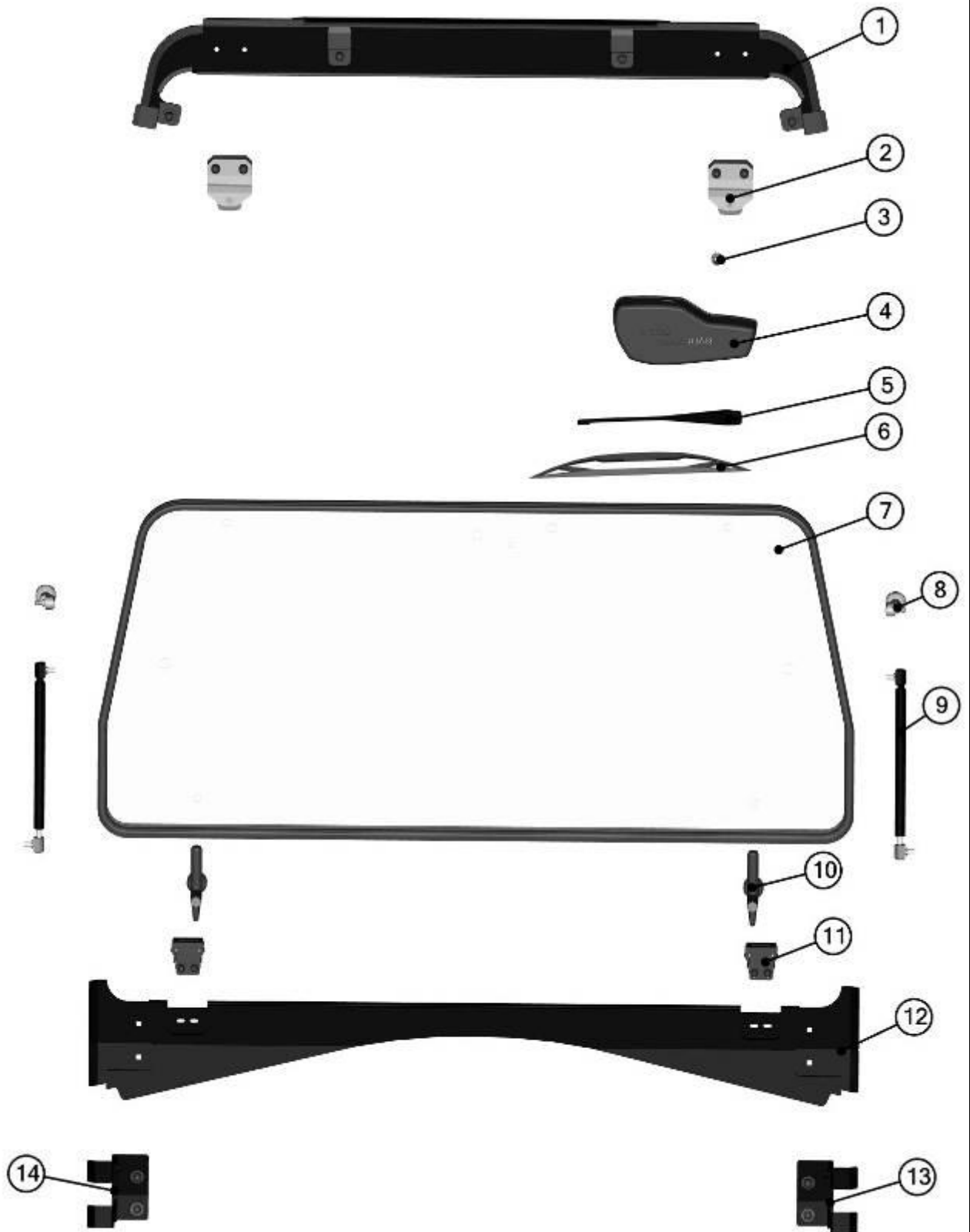

5

ID	Catalogue no.	Description	Qty
1	61S02U02-10M010	FRONT UPPER LEDGE ASSEMBLY	1
2	00-10M012	FRONT HINGE	2
3	00-01-005	GROMMET	1
4	00-10M005	WIPER MOTOR ASSEMBLY	1
5	002535	WIPER ARM	1
6	002554	WIPER LATH	1
7	61S02U02-10M002	FRONT GLASS WITH SEALING	1
8	00-20M005	GAS SPRING HOLDER	2
9	00-10M022	GAS SPRING	2
10	00-10M023	FRONT GLASS LOCK	2
11	61S02U02-10M011	FRONT GLASS STOP ASSEMBLY	2
12	61S02U02-10M004	FRONT BOTTOM LEDGE ASSEMBLY	1
13	61S02U02-10M006	RIGHT FRONT BOTTOM LEDGE HOLDER ASSEMBLY	1
14	61S02U02-10M008	LEFT FRONT BOTTOM LEDGE HOLDER ASSEMBLY	1

REAR PANEL

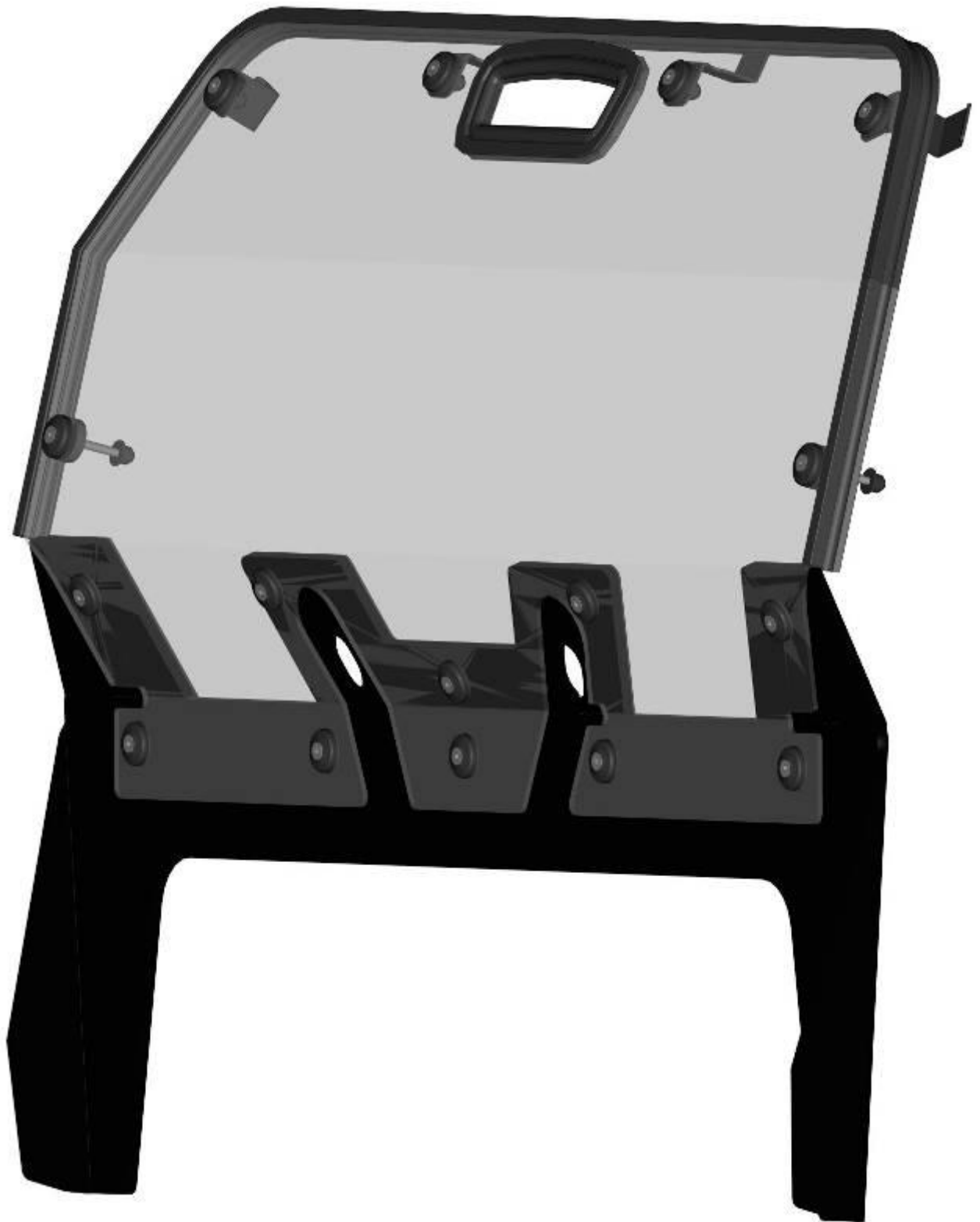



ID	Catalogue no.	Description	Qty
1	61S02U02-20M004	REAR UPPER HOLDER ASSEMBLY	2
2	61S02U02-20M005	REAR UPPER SIDE HOLDER ASSEMBLY	2
3	61S02U02-20M007	REAR FIXING ASSEMBLY	2
4	61S02U02-20M001	REAR POLYCARBONATE WITH SEALING	1
5	61S02U02-20M002	REAR BOTTOM SEALING ASSEMBLY	1

ROOF

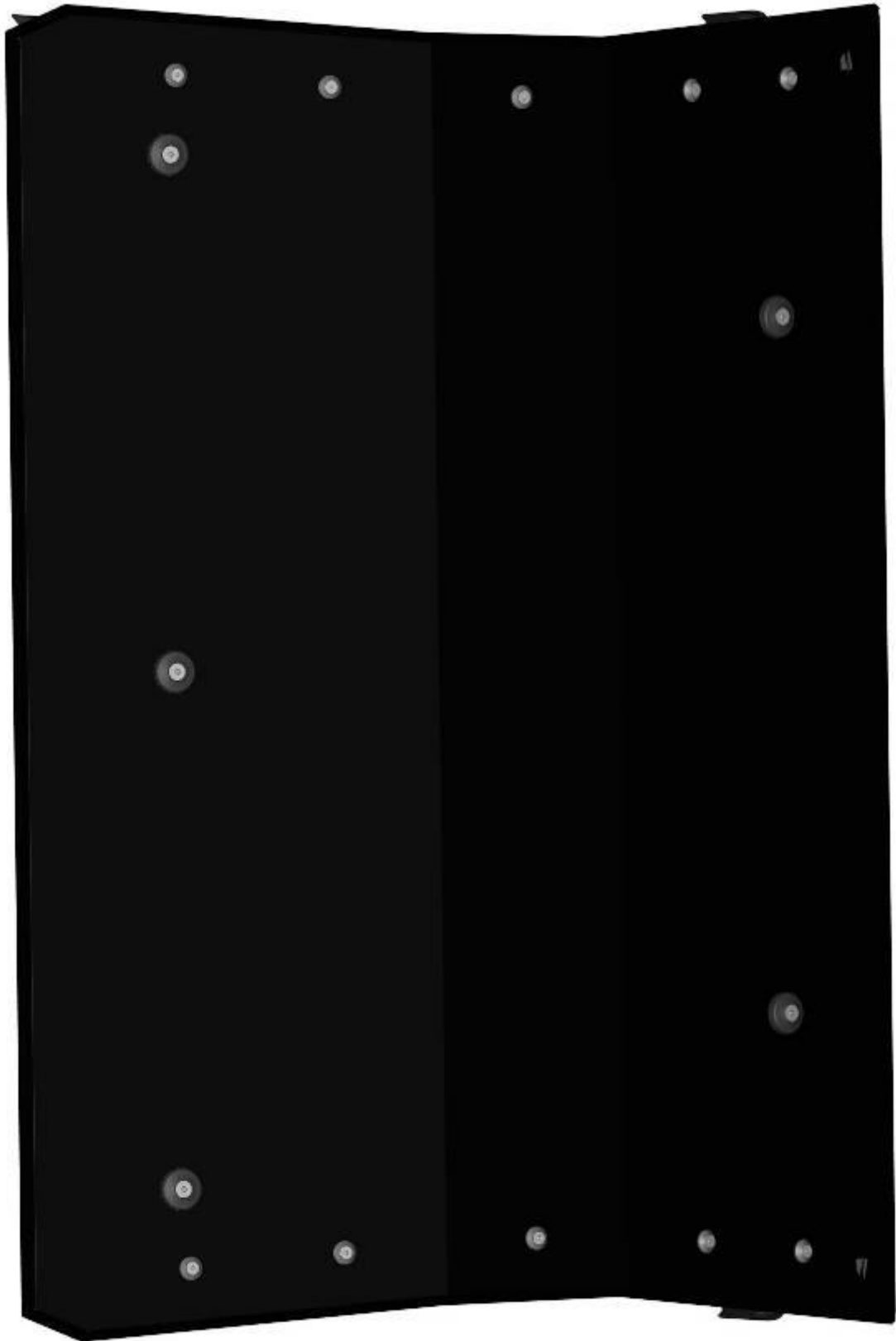

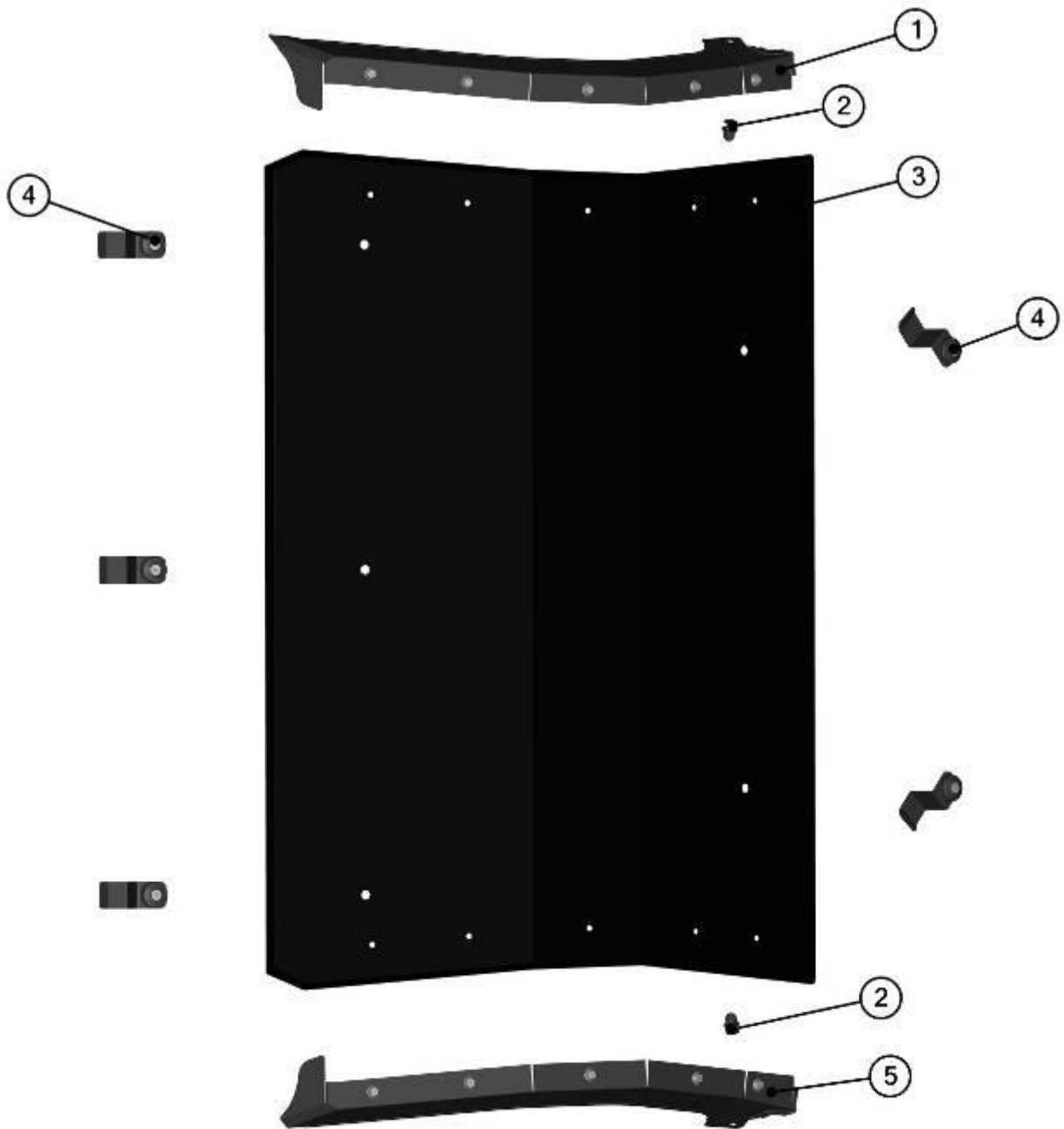

ID	Catalogue no.	Description	Qty
1	61S02U02-30M001	RIGHT ROOF LEDGE ASSEMBLY	1
2	00-117U-M006	FIXING ASSEMBLY	2
3	61S02U02-30M003	ROOF PANEL WITH SEALING	1
4	61S02U02-30M004	ROOF HOLDER ASSEMBLY	5
5	61S02U02-30M005	LEFT ROOF LEDGE ASSEMBLY	1

LEFT DOOR + RIGHT DOOR

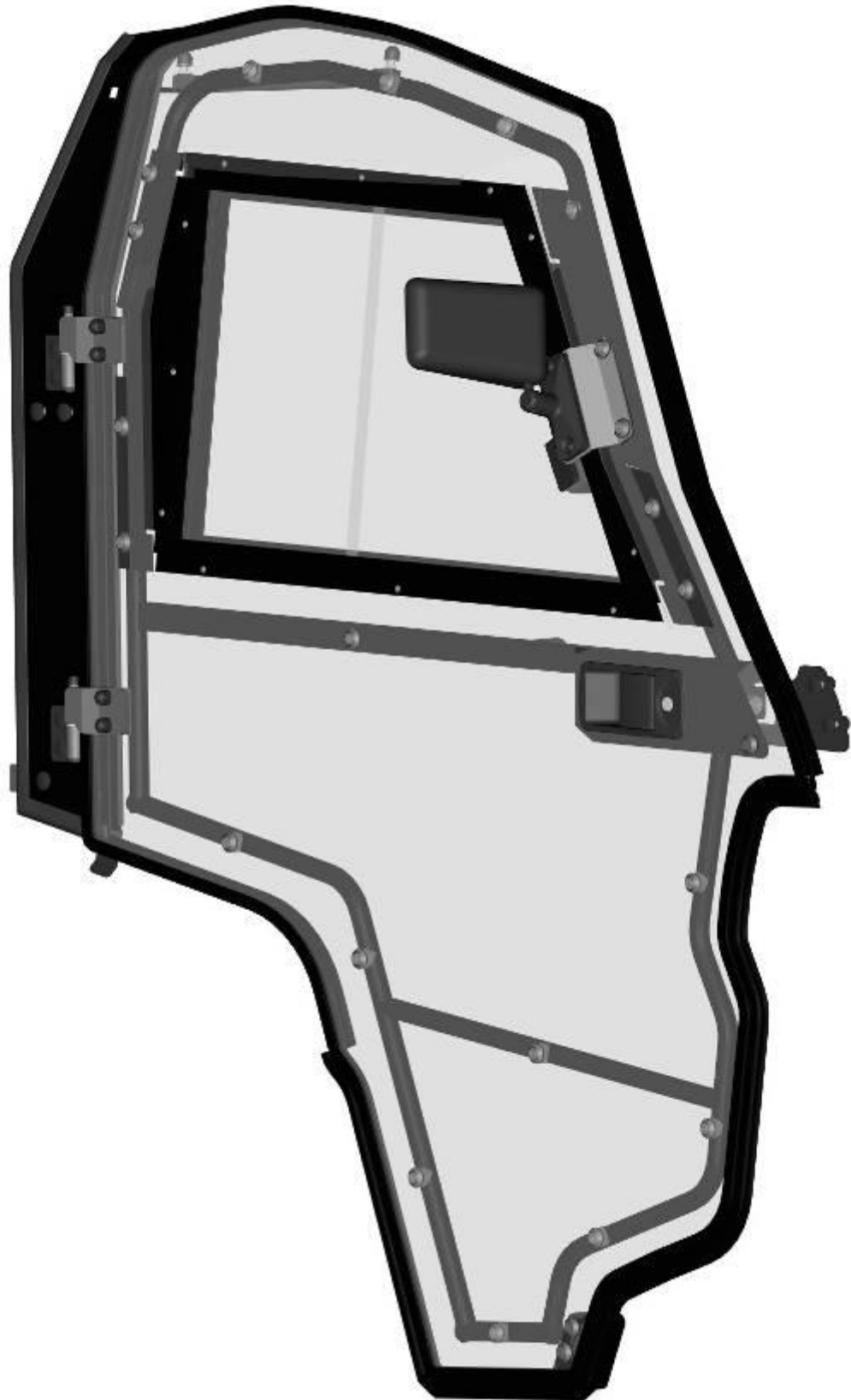

11

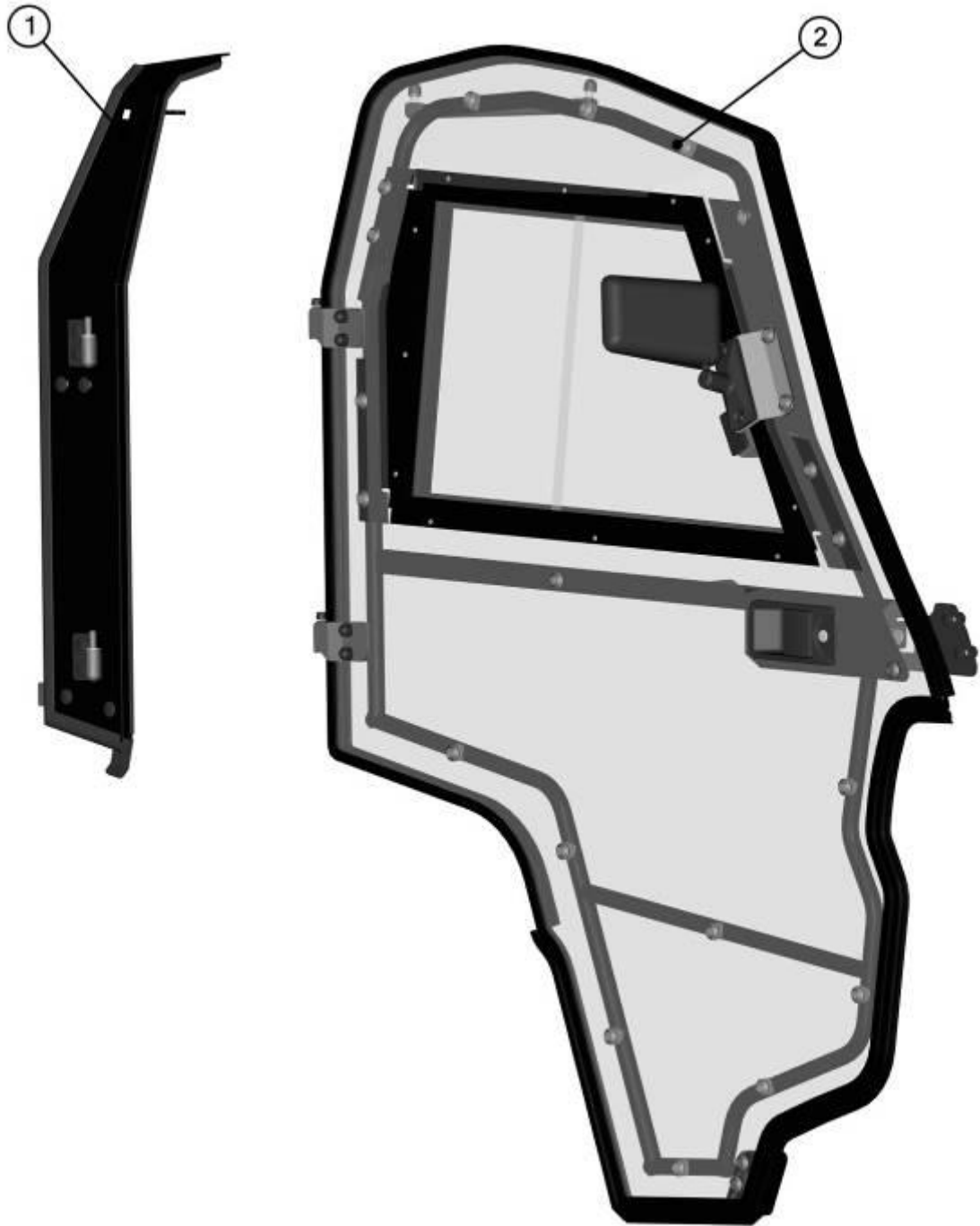

RIGHT TABLE

ID	Catalogue no.	Description	Qty
1	61S02U02-50M002	RIGHT DOOR BASE ASSEMBLY	1
2	61S02U02-50M004	RIGHT DOOR ASSEMBLY	1

LEFT TABLE

ID	Catalogue no.	Description	Qty
1	61S02U02-40M002	LEFT DOOR BASE ASSEMBLY	1
2	61S02U02-40M004	LEFT DOOR ASSEMBLY	1

DOOR BASE ASSEMBLY



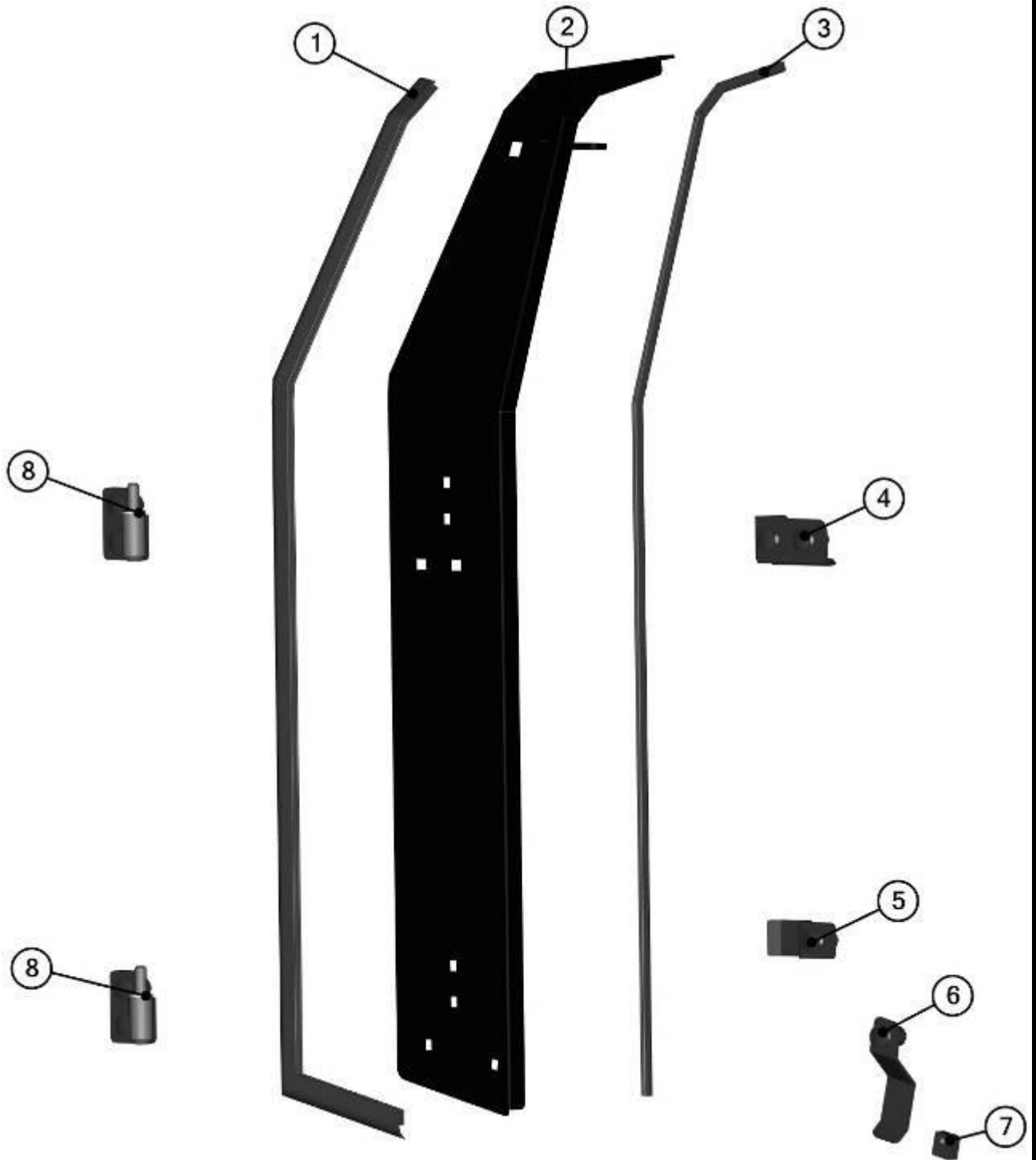

SEE NEXT PAGE

14

RIGHT TABLE

ID	Catalogue no.	Description	Qty
1	004332^61S02U02-50M001	RUBBER PROFILE "PIRELI U"	1
2	61S02U02-50W004	RIGHT DOOR BASE WELDED	1
3	001001^61S02U02-50M001	RUBBER PROFILE "LEMOVKA"	1
4	61S02U02-50M005	RIGHT DOOR BASE MIDDLE HOLDER ASSEMBLY	1
5	61S02U02-50M012	DOOR BASE BOTTOM HOLDER ASSEMBLY	1
6	61S02U02-50M006	RIGHT DOOR BASE BOTTOM HOLDER ASSEMBLY	1
7	61S02U02-50M013	DISTANCE WASHER ASSEMBLY	1
8	61S02U02-50M009	RIGHT FRAME HINGE ASSEMBLY	2

LEFT TABLE

ID	Catalogue no.	Description	Qty
1	004332^61S02U02-50M001	RUBBER PROFILE "PIRELI U"	1
2	61S02U02-40W004	LEFT DOOR BASE WELDED	1
3	001001^61S02U02-50M001	RUBBER PROFILE "LEMOVKA"	1
4	61S02U02-40M005	LEFT DOOR BASE MIDDLE HOLDER ASSEMBLY	1
5	61S02U02-50M012	DOOR BASE BOTTOM HOLDER ASSEMBLY	1
6	61S02U02-40M006	LEFT DOOR BASE BOTTOM HOLDER ASSEMBLY	1
7	61S02U02-50M013	DISTANCE WASHER ASSEMBLY	1
8	61S02U02-40M009	LEFT FRAME HINGE ASSEMBLY	2

DOOR ASSEMBLY

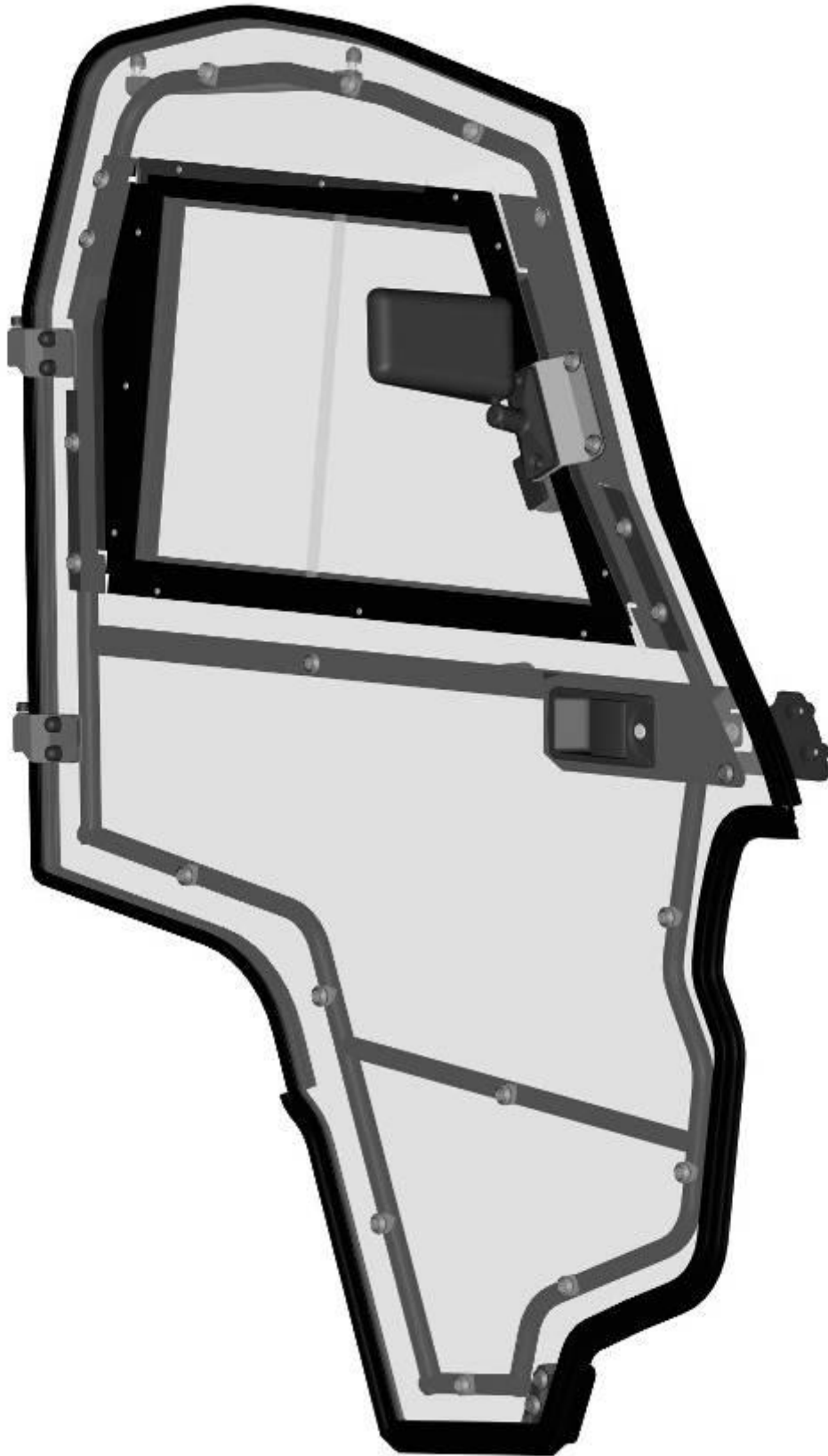

16

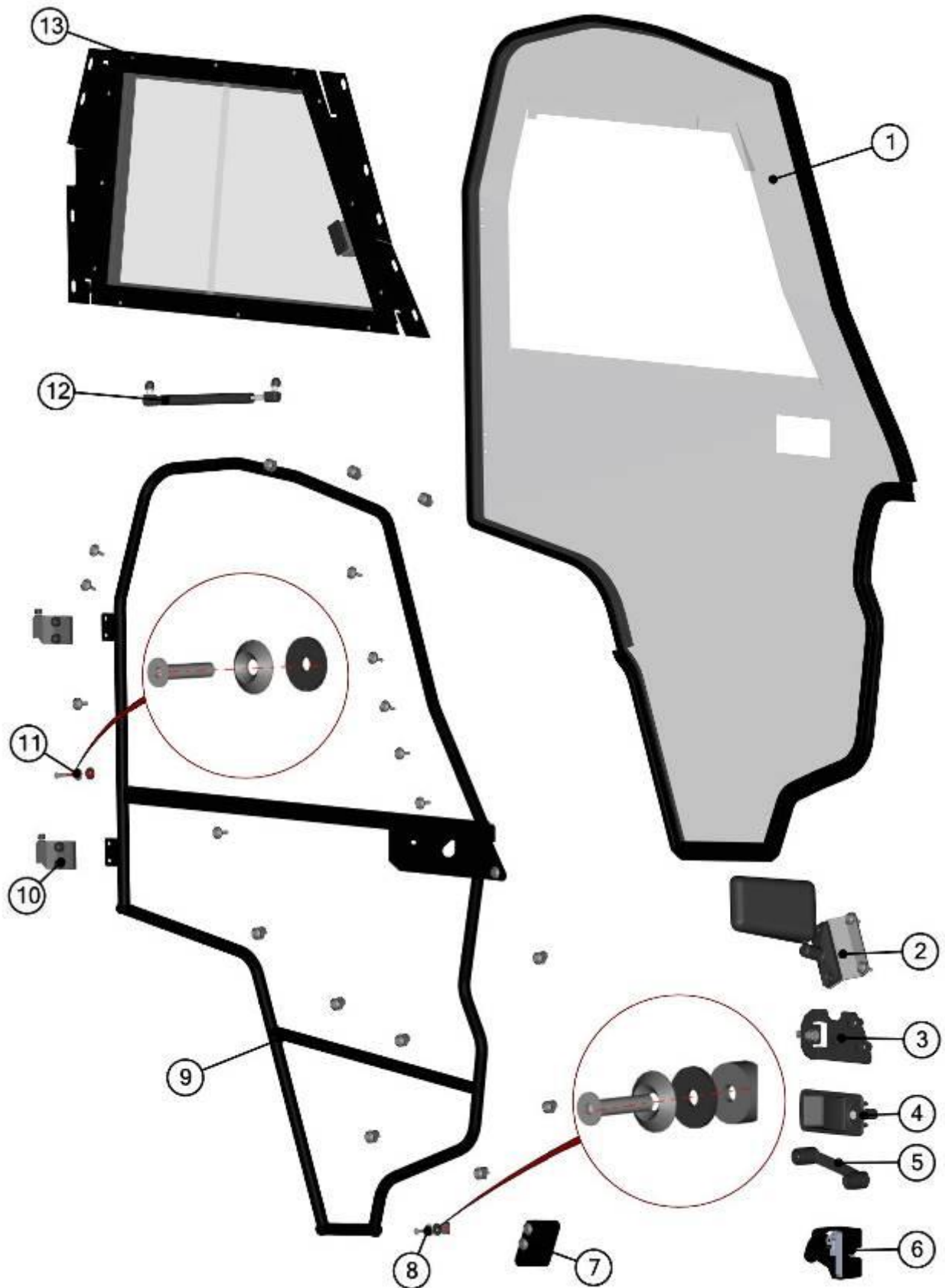

RIGHT TABLE









ID	Catalogue no.	Description	Qty
1	61S02U02-50M003	RIGHT DOOR POLYCARBONATE WITH SEALING	1
2	00-109U-M004	RIGHT DOOR MIRROR	1
3	61S02U02-50M011	RIGHT DOOR STOP ASSEMBLY	1
4	000841	OUTER DOOR LOCK	1
5	00-40M018	DOOR HANDLE	1
6	001744	RIGHT INNER DOOR LOCK	1
7	61S02U02-50M014	BOTTOM DOOR SEALING ASSEMBLY	1
8	00-00M019	POLYCARBONATE FIXING ASSEMBLY 1	11
9	61S02U02-50W001	RIGHT DOOR FRAME WELDED	1
10	00-105U-M003	RIGHT DOOR HINGE ASSEMBLY	2
11	00-00M020	POLYCARBONATE FIXING ASSEMBLY 2	10
12	61S02U02-50M010	GAS SPRING ASSEMBLY	1
13	61S02U02-50M007	RIGHT WINDOW ASSEMBLY	1









LEFT TABLE





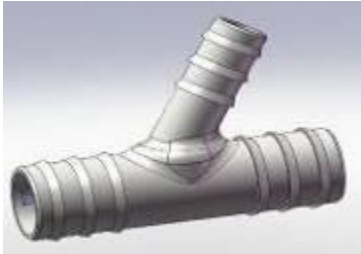



ID	Catalogue no.	Description	Qty
1	61S02U02-40M003	LEFT DOOR POLYCARBONATE WITH SEALING	1
2	00-109U-M003	LEFT DOOR MIRROR	1
3	61S02U02-40M011	LEFT DOOR STOP ASSEMBLY	1
4	000841	OUTER DOOR LOCK	1
5	00-40M018	DOOR HANDLE	1
6	001743	LEFT INNER DOOR LOCK	1
7	61S02U02-50M014	BOTTOM DOOR SEALING ASSEMBLY	1
8	00-00M019	POLYCARBONATE FIXING ASSEMBLY 1	11
9	61S02U02-40W001	LEFT DOOR FRAME WELDED	1
10	00-105U-M002	LEFT DOOR HINGE ASSEMBLY	2
11	00-00M020	POLYCARBONATE FIXING ASSEMBLY 2	10
12	61S02U02-50M010	GAS SPRING ASSEMBLY	1
13	61S02U02-40M007	LEFT WINDOW ASSEMBLY	1

ELECTROINSTALLATION

Position	Catalogue no.	Description	Qty
1	000968	SWITCH WIPER /WASHER /OFF	1
2	000885	WASHER TANK	1
3	001576	WASHER MOTOR	1
4	001652	FUSE BOX 2x1	1
5	002764	WIPER MOTOR 12V	1
6	61S02U02-01M001	WIPER HARNESS	1
7	61S02U02-02-001	HEATER HOLDER	1
8	002491	AIR VENT VALVE	1
9	002386	ELECTRIC VALVE	1
10	002795	PVC AIR HOSE	1
11	002642	TIGHTENING STRAP 14-27MM	8
12	002643	TIGHTENING STRAP 21-38MM	4
13	002705	AL SELFGLUED TAPE	1
14	002634	AIR VENT	4
15	002502	HEATER TUBE "Y"	2
16	002391	EL.VENT SWITCH	1
17	002702	HEATER SWITCH	1
18	61S02U02-02M001	HEATER HARNESS	1
19	000896	HEATER HOSE	1
20	002624	HEATER	1
21	61S02U02-03M001	WASHER HARNESS	1
22	002741	WATER PUMP	1
23	61S02U01-02PKM002	PUMP HARNESS	1
24	61S02U02-02-003	UPPER AIR VENT HOLDER	1
25	61S02U02-02W001	BOTTOM AIR VENT HOLDER WELDED	1
26	61S02U02-02-007	HEATER COVER	1
27	61S02U02-02-002	HEATER EPDM	1

		
<p>Position : 1</p>	<p>Position : 2</p>	<p>Position : 3</p>
<p>Catalogue no.: 000968</p>	<p>Catalogue no.: 000885</p>	<p>Catalogue no.: 001576</p>
		
<p>Position : 4</p>	<p>Position : 5</p>	<p>Position : 6</p>
<p>Catalogue no.: 001652</p>	<p>Catalogue no.: 002764</p>	<p>Catalogue no.: 61S02U02-01M001</p>
		
<p>Position : 7</p>	<p>Position : 8</p>	<p>Position : 9</p>
<p>Catalogue no.: 61S02U02-02-001</p>	<p>Catalogue no.: 002491</p>	<p>Catalogue no.: 002386</p>

		
<p>Position : 10</p>	<p>Position : 11</p>	<p>Position : 12</p>
<p>Catalogue no.: 002795</p>	<p>Catalogue no.: 002642</p>	<p>Catalogue no.: 002643</p>
		
<p>Position : 13</p>	<p>Position : 14</p>	<p>Position : 15</p>
<p>Catalogue no.: 002705</p>	<p>Catalogue no.: 002634</p>	<p>Catalogue no.: 002502</p>
		
<p>Position : 16</p>	<p>Position : 17</p>	<p>Position : 18</p>
<p>Catalogue no.: 002391</p>	<p>Catalogue no.: 002702</p>	<p>Catalogue no.: 61S02U02-02M001</p>

		
<p>Position : 19</p>	<p>Position :20</p>	<p>Position :21</p>
<p>Catalogue no.: 000896</p>	<p>Catalogue no.: 002624</p>	<p>Catalogue no.: 61S02U02-03M001</p>
		
<p>Position :22</p>	<p>Position :23</p>	<p>Position :24</p>
<p>Catalogue no.: 002471</p>	<p>Catalogue no.: 61S02U01-02PKM002</p>	<p>Catalogue no.: 61S02U02-02-003</p>
		
<p>Position :25</p>	<p>Position :26</p>	<p>Position :27</p>
<p>Catalogue no.: 61S02U02-02W001</p>	<p>Catalogue no.: 61S02U02-02-007</p>	<p>Catalogue no.: 61S02U02-02-002</p>